

# Michigan Wheel Marine

## *Outboard & Sterndrive Propellers 2012 Catalog*



Evinrude® • Johnson® • OMC® • Force® • Chrysler • U.S. Marine • Mercruiser® • Mercury® • Mariner®  
Nissan® • Tohatsu® • Suzuki® • Honda® • SX Cobra™ • Volvo Penta® • Yamaha®

**Tradition. Performance. Excellence.**

The new look [www.miwheel.com](http://www.miwheel.com).

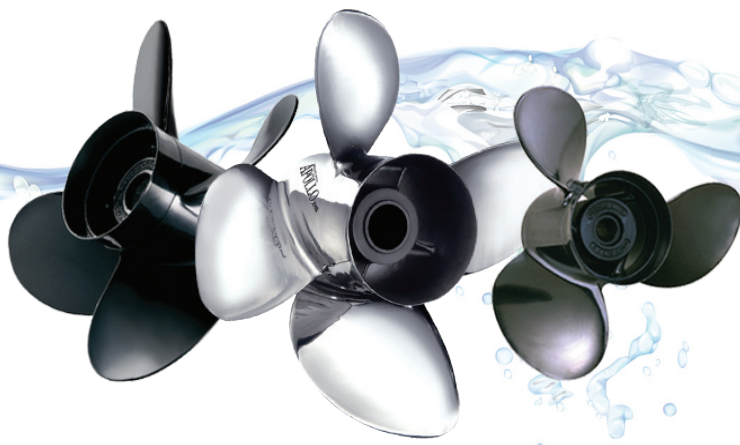

**Attention Dealers!**

Contact MWM to see how you can put our website to work for you!

1-800-369-4335

[info@miwheel.com](mailto:info@miwheel.com)

# WWW.MIWHEEL.COM

## THE MOST COMPLETE LINE OF OUTBOARD AND STERNDRIVE PROPELLERS

Visit the Brand New Michigan Wheel Website

### OBSD Propeller Selector

- Search for Propeller by Part Number
- Search for Propeller by Boat Length
- Search for Propeller by Pitch/RPM

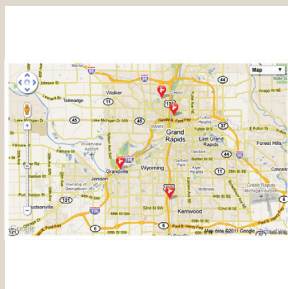

### Dealer Locator

- Locate Your Nearest Michigan Wheel Dealer by Zip Code
- Locate Your Nearest Michigan Wheel Dealer by City
- Shop for Michigan Wheel Propellers From Online Dealers

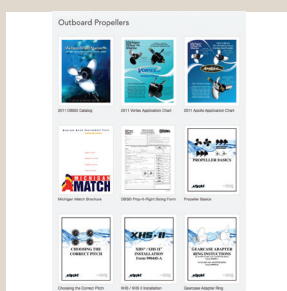

### Resource Center

- Download Michigan Wheel Marine Marketing Materials
- Download Installation Instructions
- Find Answers to Many Frequently Asked Questions

Smartphone Users:  
Scan the MWM QR Code



# TABLE OF CONTENTS

|                                   |          |
|-----------------------------------|----------|
| Propeller Basics .....            | A2 - A4  |
| Choosing the Right Propeller..... | A5       |
| Engine RPM Chart.....             | A6 - A7  |
| 2012 Michigan Propellers.....     | A8 - A11 |

## SKI & TOWBOAT PROPELLERS

|   |     |
|---|-----|
| Dyna-Jet® 3-Blade Ski Propeller.....        | A12 |
| Ambush® 4-Blade Ski/Towboat Propeller ..... | A12 |

## OUTBOARD PROPELLERS - APPLICATION GUIDE

|  |         |
|--|---------|
| How to Use the Application Guide.....        | A13     |
| Evinrude®, Johnson® Outboards.....           | 2 - 9   |
| Force®, Chrysler, U.S. Marine Outboards..... | 10 - 13 |
| Honda® Outboards .....                       | 14 - 17 |
| Mercury®, Mariner®, Sea Ray Outboards .....  | 18 - 23 |
| Nissan® / Tohatsu® Outboards.....            | 25 - 26 |
| Suzuki® Outboards.....                       | 27 - 29 |
| Yamaha® Outboards .....                      | 30 - 33 |

## STERNDRIVE PROPELLERS - APPLICATION GUIDE

|   |         |
|---|---------|
| Mercruiser® Sterndrives.....              | 34 - 35 |
| OMC® Sterndrives .....                    | 36 - 37 |
| Volvo Penta® Sterndrives .....            | 38      |
| Yamaha® Sterndrives.....                  | 39      |
| XHS® / XHS II® Propeller Accessories..... | 40-41   |

## PROPELLER CROSS REFERENCE

|   |        |
|---|--------|
| Michigan Wheel Alpha-Numeric Cross Reference.....           | B2-B4  |
| Michigan Wheel Marine - Turning Point® Cross Reference..... | B4     |
| Michigan Wheel to Solas® Cross Reference.....               | B5     |
| Michigan Wheel to Quicksilver® Cross Reference.....         | B6     |
| XHS® / XHS II® Hub System Cross Reference .....             | B7     |
| OEM Cross Reference .....                                   | B8-B34 |
| Michigan Wheel Warranty .....                               | B35    |

# PROPELLER BASICS

## Diameter

Diameter is two times the distance from the center of the hub to the tip of the blade. It also can be looked at as the distance across the circle that the propeller would make when rotating. It is the first number listed when describing a propeller.

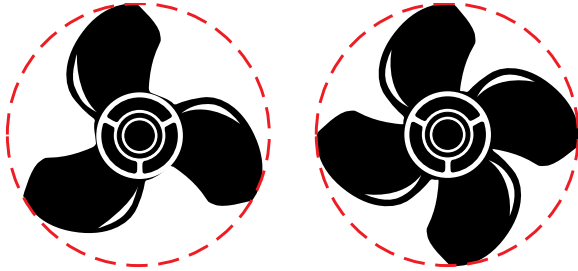

## Pitch

Pitch is defined as the theoretical forward movement of a propeller during one revolution - assuming there is no "slippage" between the propeller blade and the water. For most boats, there is slippage and therefore the distance advanced is less than the design pitch. The amount of slippage varies from boat to boat. Pitch is the second number listed in the propeller description.

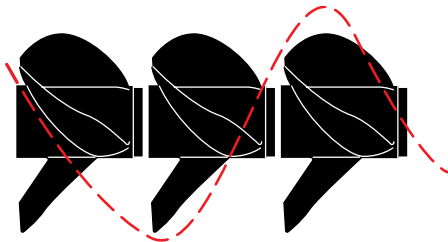

## Cupping

Many of today's propellers incorporate a cup at the trailing edge of the propeller blade. This curved lip on the propeller allows it to get a better bite on the water. This results in reduced ventilation, slipping, and allows for better hole shot in many cases. A cupped propeller also works very well where the motor can be trimmed so that the propeller is near the surface of the water. The cup will typically result in higher top end speed on one of these applications.

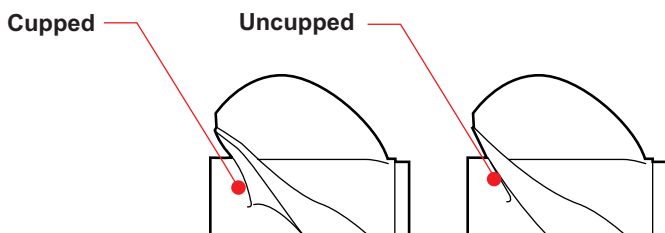

## Rake

Rake is the degree that the blades slant forward or backwards in relation to the hub. Rake can affect the flow of water through the propeller, and has implications with respect to boat performance.

Aft Rake helps to trim the bow of the boat upwards, which often results in less wetted surface area and therefore higher top end speed. Aft Rake propellers also typically provide better "bite" on ventilating-type applications.

Forward, or Negative Rake, helps hold the bow of the boat down. This is more common in workboat type applications.

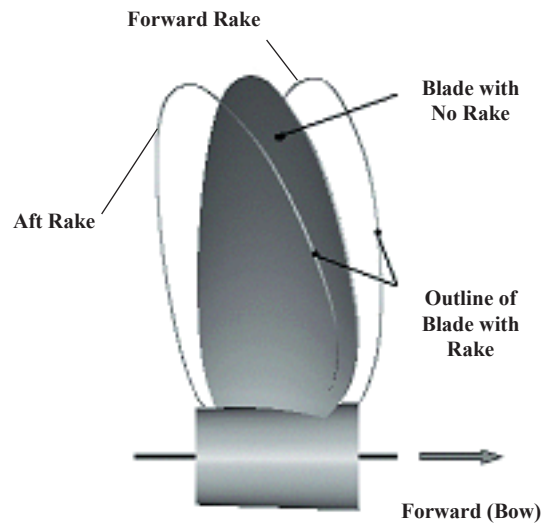

## Ventilation

Ventilation is a situation where surface air or exhaust gases are drawn into the propeller blades. When this situation occurs, boat speed is lost and engine RPM climbs rapidly. This can result from excessively tight cornering, a motor that is mounted very high on the transom, or by over-trimming the engine.

## Cavitation

Cavitation, which is often confused with ventilation, is a phenomena of water vaporizing or "boiling" due to the extreme reduction of pressure on the back of the propeller blade. Many propellers partially cavitate during normal operation, but excessive cavitation can result in physical damage to the propeller's blade surface due to the collapse of microscopic bubbles on the blade.

There may be numerous causes of cavitation such as incorrect matching of propeller style to application, incorrect pitch, physical damage to the blade edges, etc.

Be advised disturbances in the water flow forward of the propeller can result in blade damage, which appears to be blade cavitation, but is actually due to non-favorable water flow into the propeller.

# PROPELLER BASICS

Finding the right match between the propeller, engine type and boat size will optimize the following performance factors:

- Increased Top End Speed
- Faster Planing Speed (Hole Shot)
- Improved Low End Punch
- Load Carrying Capability

If you want to modify your boat's performance, consider the following before making your selection:

## 3-Blade Propeller vs. 4-Blade Propeller

We recommend 3-Blade propellers for recreational boats with 3, 4, and 6 cylinder outboards and I/O engines. These propellers provide good hole shot and top-speed performance.

We recommend 4-Blade propellers for practical, all-around boat performance. These propellers enhance handling, hole shot, load-carrying performance, and fuel efficiency.

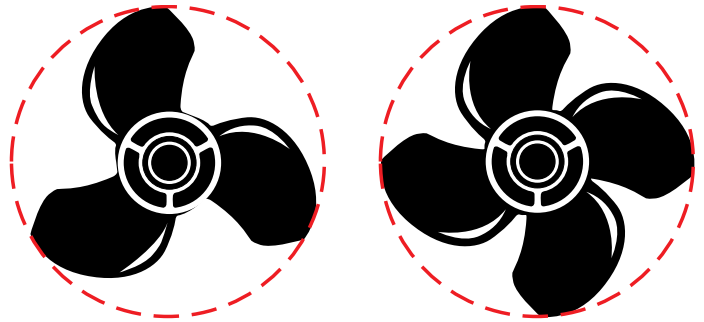

## Advantage of a Left Hand Propeller

Two propellers spinning in the same direction on twin engine boats will create steering torque. In other words, two right-hand propellers pull the stern hard to the right and the bow to the left.

Two opposite-direction (counter-rotating) propellers on twin engines eliminate this steering torque because the left-hand propeller balances out the right-hand propeller. This results in better straight-line tracking and helm control at high speed.

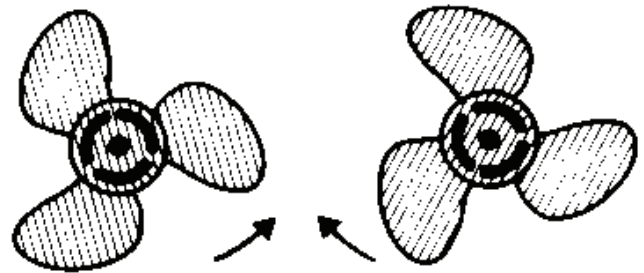

## Affect of Slip on Performance

Slip is the difference between actual and theoretical travel of the propeller blades through water. A properly matched propeller will actually move forward about 80 to 90 percent of the theoretical pitch.

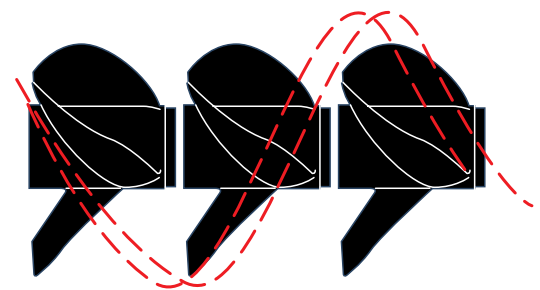

## Aluminum vs. Stainless Steel

Most pleasure boats are factory equipped with aluminum propellers. Aluminum propellers are relatively inexpensive, easy to repair, and under normal conditions can last for many years.

Stainless steel is more expensive, but much stronger and durable than aluminum. If you are looking for better performance than can be provided by your aluminum propeller, such as ultimate top speed or better acceleration, a stainless steel propeller may be required.



# PROPELLER BASICS

What is the difference between thru-hub exhaust, over-hub exhaust, and non thru-hub exhaust?

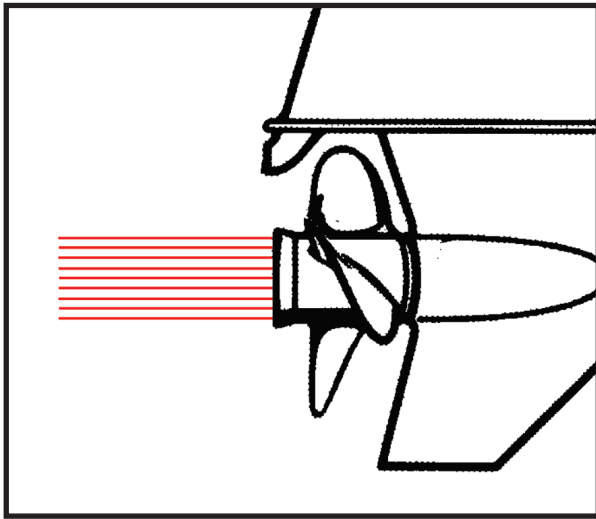

**THRU-HUB EXHAUST**

Thru-hub exhaust propellers consist of a round barrel to which the blades are attached. The exhaust passes through the barrel and out the back, without making contact with the propeller blades. This provides a good, clean water flow to the blades, usually resulting in good acceleration and hole shot.

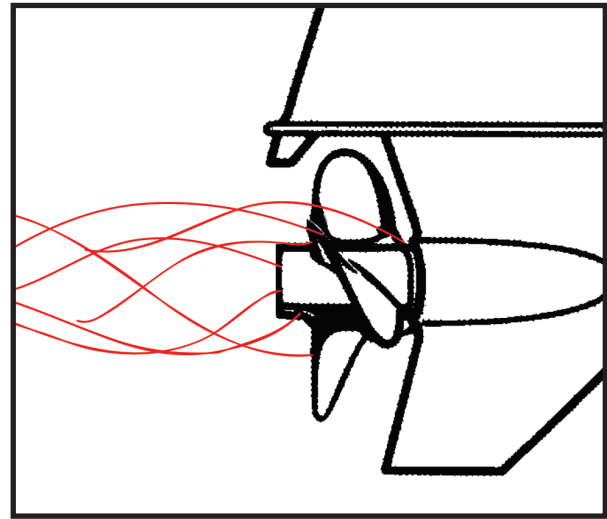

**OVER-HUB EXHAUST**

Over-hub exhaust propellers have the blades attached directly to the smaller tube that fits over the propeller shaft, eliminating the larger exhaust tube. These types of propellers are often used for attaining maximum top speeds. (On some boats, the hole shot can often suffer due to the extreme exhaust flooding that occurs around the propeller blades during acceleration.)

**THRU-HUB EXHAUST** and **OVER-HUB EXHAUST** propellers are used on boats where the exhaust passes out through the rear of the “torpedo” on the lower unit, around the propeller shaft. Most outboards utilize this type of exhaust.

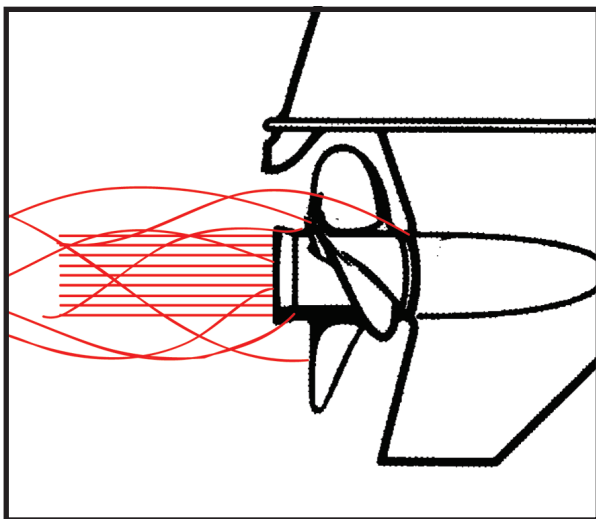

**OVER/THRU-HUB EXHAUST**

Over/Thru-hub exhaust propellers are a combination of thru-hub and over-hub exhaust propellers. This allows some exhaust to escape at lower RPM, providing a controlled amount of exhaust flooding. These types of propellers will allow the propeller to be slightly easier to turn during initial acceleration, allowing for better hole shot on some engine/boat combinations.

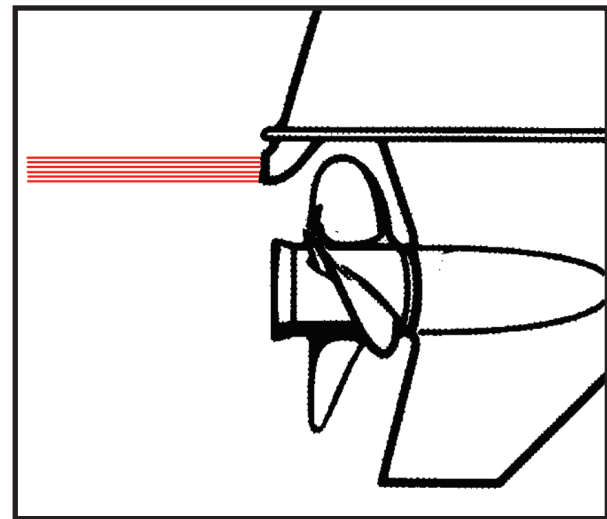

**NON THRU-HUB EXHAUST**

Non thru-hub exhaust propellers are used for inboards using shaft driven propellers, sterndrives using through hull exhaust, and on some outboards that don't route the exhaust through the lower unit torpedo.

# CHOOSING THE CORRECT PITCH

For safety and efficient performance, it is critical that your engine operates within the RPM range recommended by the manufacturer. Matching the right prop for the load is the most significant factor when choosing a new propeller.

## 1) Determine Manufacturer's Recommended RPM

Find the manufacturer's recommended RPM range in the owner's manual or ask your dealer. A reference chart showing common engine applications is shown on Pages A6-A7 of this catalog.

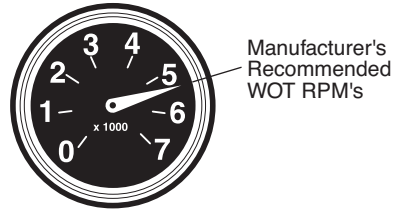

## 2) Test for Maximum RPM

Using the existing propeller or a new propeller, make test runs to determine the maximum RPM and boat speed. Vary the trim angle for optimum performance.



## 3a) If RPM are Higher Than Recommended

If the actual WOT RPM are *above* the recommended RPM range, install the next larger pitch propeller to *decrease* your WOT RPM. Re-test the WOT RPM.

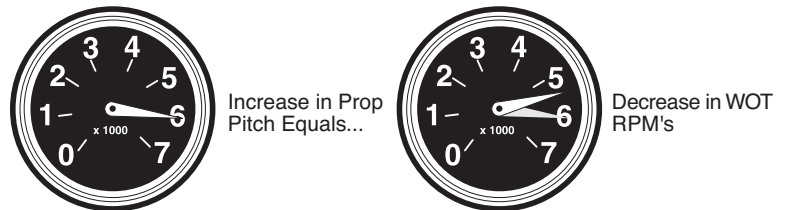

## 3b) If RPM are Lower Than Recommended

If the actual WOT RPM range is *below* the recommended range, install the next smaller pitch propeller to *increase* your WOT RPM. Re-test the WOT RPM.

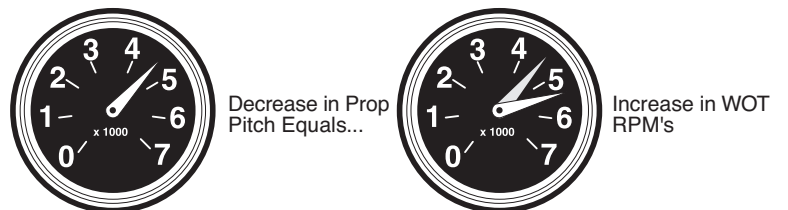

*When you combine all these factors, you have the information you need to select the correct propeller for maximum performance, safety, and fuel efficiency.*

## Effect of Propeller Pitch on RPM

A pitch change can increase or decrease the RPM and bring RPM into the recommended range. A 2" increase in pitch (for example, from 21" to 23") typically results in a decrease of approximately 300-400 RPM.

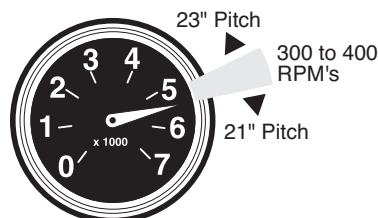

# ENGINE RPM CHART

## EVINRUDE® RPM CHART

| HP/Model          | Years     | WOT RPM   | Gear Ratio |
|-------------------|-----------|-----------|------------|
| 9.9 HP            | 1974-1984 | 4500-5000 | 2.42       |
| 9.9 HP            | 1985-2005 | 5000-6000 | 2.42       |
| 15 HP             | 1974-1980 | 5500-6500 | 2.42       |
| 15 HP             | 1981-1993 | 5500-7000 | 2.42       |
| 15 HP             | 1997-2005 | 5000-6000 | 2.42       |
| 65 HP*            | 1984-2000 | 4500-5500 | 2.42       |
| 65 HP*            | 2001      | 5000-6000 | 2.25       |
| 90 HP Ficht       | 1998      | 4500-5500 | 2.00       |
| 90 HP Ficht       | 1999-2000 | 5500-6000 | 2.00       |
| 90 HP Ram         | 2001-2003 | 5250-5750 | 2.00       |
| 115 HP Ficht      | 1998      | 5000-6000 | 2.00       |
| 115 HP Ficht      | 1999-2000 | 5500-6000 | 2.00       |
| 115 HP Ram        | 2001-2003 | 5250-5750 | 2.00       |
| 150 HP Ficht      | 1999-2000 | 4800-5300 | 1.86       |
| 150 HP Ram        | 2001-2003 | 4750-5250 | 1.86       |
| 175 HP Ficht      | 1999-2000 | 5300-5800 | 1.86       |
| 175 HP Ram        | 2001-2003 | 5250-5750 | 1.86       |
| 200 HP Ficht      | 2001-2002 | 5500-6000 | 1.86       |
| 200 HP Ram        | 2003      | 5000-6000 | 1.85       |
| 225 HP Ficht      | 1999-2000 | 5500-6000 | 1.86       |
| 225 HP Ficht H.O. | 2003      | 5500-6000 | 1.86       |
| 225 HP Ram        | 2001-2003 | 5500-6000 | 1.86       |
| 250 HP Ficht      | 2000      | 5500-6000 | 1.86       |
| 250 HP Ram        | 2001-2003 | 5500-6000 | 1.86       |

\*Commercial Models.

## EVINRUDE® 4-STROKE RPM CHART

| HP/Model | Years     | WOT RPM   | Gear Ratio |
|----------|-----------|-----------|------------|
| 5 HP     | 1999      | 5500-6500 | 2.23       |
| 5 HP     | 2000-2003 | 5000-6000 | 2.23       |
| 6 HP     | 1998-1999 | 5500-6500 | 2.23       |
| 6 HP     | 2000-2002 | 5000-6000 | 2.23       |
| 8 HP     | 1996-2002 | 5000-6000 | 2.42       |
| 9.9 HP   | 1995-2001 | 5000-6000 | 2.42       |
| 15 HP    | 1995-2001 | 5000-6000 | 2.42       |
| 25 HP    | -         | 4700-5300 | 2.09       |
| 30 HP    | -         | 5200-5800 | 2.27       |
| 40 HP    | 1999-2003 | 5200-5800 | 2.27       |
| 50 HP    | 1999-2003 | 5900-6500 | 2.27       |
| 70 HP    | 1998      | 5000-6000 | 2.42       |
| 70 HP    | 1999-2003 | 5200-5800 | 2.42       |

## EVINRUDE® E-TEC® RPM CHART

| HP/Model    | Years     | WOT RPM   | Gear Ratio  |
|-------------|-----------|-----------|-------------|
| 25 HP       | 2009 Thru | 5000-6000 | 2.15        |
| 30 HP       | 2009 Thru | 5000-6000 | 2.15        |
| 40 HP       | 2004 Thru | 5500-6000 | 2.67        |
| 50 HP       | 2004 Thru | 5500-6000 | 2.67        |
| 55 HP       | 2009 Thru | 5500-6000 | 2.67        |
| 60 HP       | 2004 Thru | 5500-6000 | 2.67        |
| 75 HP       | 2004 Thru | 4500-5500 | 2.00        |
| 90 HP       | 2004 Thru | 4500-5500 | 2.00 / 2.25 |
| 115 HP      | 2004-2007 | 4500-5500 | 2.00 / 2.25 |
| 115 HP      | 2008 Thru | 5000-6000 | 2.00        |
| 130 HP      | 2004-2008 | 5000-6000 | 2.00 / 2.25 |
| 130 HP      | 2009 Thru | 5500-6000 | 2.00 / 2.25 |
| 150 HP      | 2009 Thru | 4850-5850 | 1.86        |
| 150 HP H.O. | 2009 Thru | 4850-5850 | 1.86        |
| 175 HP      | 2008 Thru | 4850-5850 | 1.86        |
| 200 HP      | 2006      | 4750-5750 | 1.86        |
| 200 HP      | 2007 Thru | 4850-5850 | 1.86        |
| 200 HP H.O. | 2006 Thru | 4500-5800 | 1.86        |
| 225 HP      | 2006 Thru | 4500-5800 | 1.86        |
| 225 HP H.O. | 2006-2008 | 4500-5800 | 1.86        |
| 225 HP H.O. | 2009 Thru | 4500-5800 | 1.71        |
| 250 HP      | 2006 Thru | 4500-5800 | 1.85        |
| 250 HP H.O. | 2008 Thru | 4500-6000 | 1.71        |
| 300 HP      | 2009 Thru | 5000-6000 | 1.86        |

## JOHNSON® RPM CHART

| HP/Model     | Years     | WOT RPM   | Gear Ratio |
|--------------|-----------|-----------|------------|
| 4 HP         | 1980-1983 | 4000-5000 | 1.65       |
| 6 HP         | 1986-2005 | 4500-5500 | 2.23       |
| 8 HP         | 2000-2005 | 5000-6000 | 2.23       |
| 9.9 HP       | 2000-2005 | 5000-6000 | 2.42       |
| 15 HP        | 2000-2004 | 5000-6000 | 2.42       |
| 15 HP        | 2005-2007 | 5500-6500 | 2.42       |
| 25 HP        | 1984-2005 | 4500-5500 | 2.15       |
| 25 HP 3 Cyl. | 1984-2005 | 5200-5800 | 2.15       |
| 30 HP        | 1984-2000 | 5200-5800 | 2.15       |
| 30 HP        | 2001-2005 | 4500-5500 | 2.23       |
| 35 HP        | 1981-1983 | 5200-5800 | 1.93       |
| 40 HP        | 1984-2005 | 4500-5500 | 2.42       |
| 50 HP        | 1975-2005 | 4500-5500 | 2.42       |
| 60 HP 3 Cyl. | 1989-2003 | 5000-6000 | 2.42       |
| 70 HP 3 Cyl. | 1974-2001 | 4500-5500 | 2.42       |
| 90 HP*       | 2001-2006 | 4500-5500 | 2.00       |
| 115 HP*      | 2001-2006 | 4500-5500 | 2.00       |
| 135 HP*      | -         | 5000-6000 | 2.25       |
| 150 HP*      | 2003-2006 | 4500-5500 | 1.86       |
| 175 HP*      | 2003-2006 | 4500-5500 | 1.86       |
| 200 HP*      | 1987-2001 | 5000-6000 | 1.86       |
| 225 HP*      | 1986-2001 | 5000-6000 | 1.86       |

\*Includes OceanPro Models.

## JOHNSON® 4-STROKE RPM CHART

| HP/Model | Years     | WOT RPM   | Gear Ratio |
|----------|-----------|-----------|------------|
| 6 HP     | 1997-2003 | 5500-6500 | 2.23       |
| 8 HP     | 1996-2004 | 5000-6000 | 2.42       |
| 9.9 HP   | 2002-2007 | 4500-5500 | 1.92       |
| 15 HP    | 2002-2007 | 5400-6000 | 1.92       |
| 25 HP    | 2004-2006 | 5000-5600 | 2.09       |
| 30 HP    | 2004-2007 | 5500-6100 | 2.09       |
| 40 HP    | 1999-2005 | 5200-5800 | 2.27       |
| 50 HP    | 1999-2005 | 5900-6500 | 2.27       |
| 60 HP    | 1998-2005 | 4700-5300 | 2.42       |
| 70 HP    | 1999-2005 | 5200-5800 | 2.42       |
| 90 HP    | 2003-2005 | 4500-5500 | 2.59       |
| 115 HP   | 2003-2005 | 5000-6000 | 2.59       |
| 140 HP   | 2003-2005 | 5600-6200 | 2.38       |
| 200 HP   | 2004-2005 | 5000-6000 | 2.29       |
| 225 HP   | 2004-2005 | 5000-6000 | 2.29       |

## MERCURY® RPM CHART

| HP/Model   | Years     | WOT RPM   | Gear Ratio |
|------------|-----------|-----------|------------|
| 4 HP       | 1973-1975 | 4500-5500 | 2.00       |
| 6 HP       | 1994-2003 | 4000-5000 | 2.00       |
| 8 HP       | 1994-2005 | 4500-5500 | 2.00       |
| 9.9 HP     | 1993-2005 | 5000-6000 | 2.00       |
| 15 HP      | 1994-2005 | 5000-6000 | 2.00       |
| 20 HP      | 1986-2005 | 4500-5500 | 2.25       |
| 25 HP      | 1985-2005 | 5000-6000 | 2.25       |
| 30 HP      | 1994-2002 | 4500-5500 | 2.00       |
| 40 HP      | 2001-2002 | 4500-5500 | 2.00       |
| 40 HP      | 2004-2005 | 5000-5500 | 1.83       |
| 50 HP      | 1991 Thru | 5000-5500 | 1.83       |
| 60 HP      | 1991-2005 | 5000-5500 | 1.64       |
| 75 HP      | 1990-2005 | 4750-5250 | 2.30       |
| 90 HP      | 1989-2004 | 5000-5500 | 2.30       |
| 90 HP      | 2005 Thru | 5000-5500 | 2.33       |
| 100 HP     | 1989 Thru | 4750-5250 | 2.07       |
| 115 HP     | 1989-2005 | 4750-5250 | 2.07       |
| 125 HP     | 1994-2005 | 4750-5250 | 2.07       |
| 135 HP     | 1990-1996 | 5000-5600 | 2.00       |
| 150 HP EFI | 2004      | 5000-6000 | 1.87       |
| 150 HP EFI | 2005      | 5000-5600 | 1.87       |
| 175 HP     | 1990-1999 | 5000-5600 | 1.87       |
| 175 HP EFI | 2000-2002 | 5000-5600 | 1.87       |
| 200 HP     | 1991-2005 | 5000-5600 | 1.87       |
| 200 HP EFI | 1994-2002 | 5000-5800 | 1.87       |
| 225 HP     | 1996-1998 | 5000-5500 | 1.64       |
| 225 HP EFI | 1996-2004 | 5000-5800 | 1.75       |

## MERCURY® 4-STROKE RPM CHART

| HP/Model       | Years     | WOT RPM   | Gear Ratio |
|----------------|-----------|-----------|------------|
| 8 HP           | 1995-2004 | 4500-5500 | 2.00       |
| 8 HP           | 2005 Thru | 5000-6000 | 2.08       |
| 9.9 HP         | 1995-2004 | 4500-5500 | 2.01       |
| 9.9 HP         | 2005 Thru | 5000-6000 | 2.08       |
| 9.9 HP Bigfoot | 1999-2004 | 4500-5500 | 2.42       |
| 15 HP          | 1989-2006 | 4500-5500 | 2.00       |
| 25 HP          | 2004-2005 | 5500-6000 | 2.42       |
| 25 HP          | 2006 Thru | 5000-6000 | 1.92       |
| 25 HP Bigfoot  | 1999-2001 | 5500-6000 | 2.40       |
| 25 HP Bigfoot  | 2002-2003 | 5250-5750 | 2.40       |
| 30 HP          | 1999-2005 | 5500-6000 | 2.00       |
| 30 HP          | 2006 Thru | 5250-6250 | 1.92       |
| 40 HP          | 1997 Thru | 5500-6000 | 2.00       |
| 50 HP          | 1998 Thru | 5500-6000 | 1.83       |
| 50 HP Bigfoot  | All Years | 5500-6000 | 2.33       |
| 60 HP          | 2001 Thru | 5500-6000 | 1.83       |
| 60 HP Bigfoot  | 2001 Thru | 5500-6000 | 2.33       |
| 75 HP          | 2004-2006 | 4500-5500 | 2.33       |
| 75 HP          | 2007 Thru | 5000-6000 | 2.33       |
| 90 HP          | 2004 Thru | 5000-6000 | 2.33       |
| 115 HP         | 2001-2006 | 5000-6000 | 2.07       |
| 115 HP EFI     | 2007 Thru | 5800-6400 | 2.07       |

## MERCURY® OPTIMAX® RPM CHART

| HP/Model      | Years     | WOT RPM   | Gear Ratio |
|---------------|-----------|-----------|------------|
| 75 HP         | -         | 5000-5750 | 2.33       |
| 90 HP         | 2005 Thru | 5000-5500 | 2.33       |
| 115 HP        | 2007 Thru | 5000-5700 | 2.07       |
| 135 HP        | 1996-2007 | 5000-5600 | 2.00       |
| 135 HP        | 2008 Thru | 5250-5750 | 2.00       |
| 150 HP        | 2004 Thru | 5250-5750 | 1.87       |
| 175 HP        | 2000 Thru | 5250-5750 | 1.87       |
| 175 HP Pro XS | 2008 Thru | 5500-6000 | 1.87       |
| 200 HP        | 1998 Thru | 5000-5750 | 1.75       |
| 225 HP        | 1998 Thru | 5000-5750 | 1.75       |
| 225 HP Pro XS | 2006 Thru | 5500-6000 | 1.75       |
| 225 HP SW     | -         | 5000-5750 | 1.75       |
| 250 HP        | 2007 Thru | 5500-6000 | 1.75       |
| 250 HP Pro XS | -         | 5500-6000 | 1.75       |

## MERCURY® VERADO® RPM CHART

| HP/Model      | Years     | WOT RPM   | Gear Ratio |
|---------------|-----------|-----------|------------|
| 135 HP Verado | 2007 Thru | 5200-6400 | 2.08       |
| 150 HP Verado | 2006 Thru | 5800-6400 | 2.08       |
| 175 HP Verado | 2006 Thru | 5800-6400 | 2.08       |
| 200 HP Verado | 2005 Thru | 5800-6400 | 2.08       |
| 225 HP Verado | 2005 Thru | 5800-6400 | 1.85       |
| 250 HP Verado | 2005 Thru | 5800-6400 | 1.85       |
| 275 HP Verado | 2005 Thru | 5800-6400 | 1.85       |
| 300 HP Verado | 2008 Thru | 5800-6400 | 1.75       |

## MERCURUISER® RPM CHART

| HP/Model                   | WOT RPM   | Gear Ratio |
|----------------------------|-----------|------------|
| 3.0 L 135                  | 4400-4800 | 2.00 A1    |
| 4.3 L 190                  | 4400-4800 | 1.81 A1    |
| 4.3 LH 205                 | 4400-4800 | 1.62 A1    |
| 4.3 L EFI 210              | 4400-4800 | 1.62 A1    |
| 4.3 L MPI 220 HP           | 4400-4800 | 1.62 A1    |
| 5.0 L 220                  | 4400-4800 | 1.62 A1    |
| 5.0 L 220                  | 4400-4800 | 1.65 B1    |
| 5.0 L EFI 240              | 4400-4800 | 1.47 A1    |
| 5.0 L EFI 240              | 4400-4800 | 1.65 B1    |
| 5.0 L MPI 260 HP           | 4600-5000 | 1.62 A1    |
| 5.0 L MPI 260 HP           | 4600-5000 | 1.50 B1    |
| 5.7 L 250                  | 4400-4800 | 1.47 A1    |
| 5.7 L 250                  | 4400-4800 | 1.65 B1    |
| 5.7 L EFI 260              | 4400-4800 | 1.47 A1    |
| 5.7 L EFI 260              | 4400-4800 | 1.65 B1    |
| 350 Mag MPI 300            | 4800-5200 | 1.47 A1    |
| 350 Mag MPI 300            | 4800-5200 | 1.50 B1    |
| 350 Map MPI Horizon 300 HP | 4800-5200 | 1.50 B1    |
| 350 Horizon 300            | 4600-5000 | 1.47 A1    |
| 350 Horizon 300            | 4600-5000 | 1.50 B1    |
| MX 6.2 L MPI 320           | 4800-5200 | 1.65 B1    |
| 496 Mag 375                | 4400-4800 | 1.50 B1    |
| 496 Mag H.O. 425           | 4600-5000 | 1.50 B1    |



# ENGINE RPM CHART

## HONDA® RPM CHART

| HP/Model    | Years     | WOT RPM   | Gear Ratio |
|-------------|-----------|-----------|------------|
| BF 8        | 1987-1999 | 4950-5500 | 2.40       |
| BF 9.9      | 1988-1999 | 4500-5500 | 2.10       |
| BF 9.9      | 2000 Thru | 5000-6000 | 2.33       |
| BF 15       | 1991-2002 | 5000-6200 | 2.10       |
| BF 15       | 2003 Thru | 4500-5500 | 2.08       |
| BF 20       | 2003 Thru | 5000-6000 | 2.08       |
| BF 25       | 1994 Thru | 5000-6000 | 2.08       |
| BF 30       | 1995-1999 | 5500-6000 | 2.08       |
| BF 30       | 2000-2005 | 5700-6200 | 2.08       |
| BF 30       | 2006 Thru | 5000-6000 | 2.08       |
| BF 35       | 1991-1994 | 4600-5600 | 2.09       |
| BF 40       | 1995 Thru | 5000-6000 | 2.09       |
| BF 45       | 1991-1994 | 5000-6000 | 2.09       |
| BF 50 / 50A | 1995 Thru | 5500-6000 | 2.09       |
| BF 60       | 2010 Thru | 5000-6000 | 2.07       |
| BFP 60      | 2010 Thru | 5000-6000 | 2.33       |
| BF 75       | 1995 Thru | 5000-6000 | 2.33       |
| BF 90       | 1995-2002 | 5000-6000 | 2.33       |
| BF 90       | 2003-2006 | 5000-6000 | 2.30       |
| BF 90       | 2007 Thru | 5300-6300 | 2.33       |
| BF 115      | 1998 Thru | 5000-6000 | 2.00       |
| BF 130      | 1998-2004 | 5000-6000 | 2.00       |
| BF 135      | 2004 Thru | 5000-6000 | 2.14       |
| BF 150      | 2004 Thru | 5000-6000 | 2.14       |
| BF 200      | 2002 Thru | 5000-6000 | 1.86       |
| BF 225      | 2002 Thru | 5000-6000 | 1.86       |

## NISSAN®/TOHATSU® RPM CHART

| HP/Model        | Years     | WOT RPM   | Gear Ratio |
|-----------------|-----------|-----------|------------|
| 9.9 HP          | 1984-1998 | 4500-5300 | 1.85       |
| 9.9 HP 4-Stroke | 2000      | 4500-5500 | 2.15       |
| 15 HP           | 1998-2000 | 5200-5800 | 1.85       |
| 15 HP 4-Stroke  | 2000 Thru | 5000-6000 | 2.15       |
| 18 HP           | 1985-1997 | 4750-5500 | 1.85       |
| 18 HP           | 1998-2001 | 5200-5800 | 1.85       |
| 18 HP 4-Stroke  | 2001-2008 | 5000-6000 | 2.12       |
| 20 HP 4-Stroke  | 2007 Thru | 5400-6100 | 2.15       |
| 25 HP           | 1986-1998 | 4800-5500 | 1.92       |
| 25 HP           | 1999-2001 | 5000-6000 | 1.92       |
| 25 HP 4-Stroke  | 2002 Thru | 5000-6000 | 1.92       |
| 30 HP           | 1985-1998 | 4800-5500 | 1.92       |
| 30 HP           | 1999-2001 | 5150-5850 | 1.92       |
| 30 HP 4-Stroke  | 2002 Thru | 5250-6250 | 1.92       |
| 40 HP (40D)     | 1990-1999 | 4500-5500 | 1.85       |
| 40 HP TLDI      | 2003 Thru | 5150-5850 | 1.85       |
| 50 HP           | 1991-1999 | 5000-5700 | 1.85       |
| 50 HP           | 2000 Thru | 5150-5850 | 1.85       |
| 50 HP TLDI      | 2003 Thru | 5150-5850 | 1.85       |
| 70 HP           | 1992-1997 | 4900-5600 | 2.30       |
| 70 HP TLDI      | 1998 Thru | 5150-5850 | 2.30       |
| 75 HP TLDI      | 2010 Thru | 5150-5850 | 2.33       |
| 90 HP           | 1987-1999 | 5000-5500 | 2.00       |
| 90 HP           | 2000-2009 | 5150-5850 | 2.00       |
| 90 HP           | 2010 Thru | 5150-5850 | 2.33       |
| 115 HP          | 1993-2002 | 5200-5700 | 2.00       |
| 115 HP          | 2003 Thru | 5150-5850 | 2.00       |
| 120 HP          | 1992-2003 | 5200-5700 | 2.00       |
| 140 HP          | 1992-2003 | 5200-5700 | 2.00       |

## OMC® RPM CHART

| HP/Model             | WOT RPM   | Gear Ratio |
|----------------------|-----------|------------|
| 1.6 L V4 Sea Drive   | 4500-5500 |            |
| 1.8 L V4 Sea Drive   | 5000-6000 |            |
| 2.3 L Cobra          | 5200-5600 | 2.00       |
| 2.5 L Sea Drive      | 5000-5500 | 1.86       |
| 2.5 L Model 400      | 4200-4600 |            |
| 2.6 L Sea Drive      | 5000-5500 | 1.86       |
| 3.0 L Model 400      | 4200-4600 | 1.85       |
| 3.8 L Sea Drive      | 4200-4600 |            |
| 4.3 L                | 4200-4600 | 1.66       |
| 5.0 L                | 4200-4600 | 1.66       |
| 5.0 L EFI            | 4200-4600 | 1.60       |
| 5.8 L                | 4000-4400 | 1.51       |
| 5.8 L EFI            | 4200-4600 | 1.51       |
| 5.8 L King Cobra EFI | 4600-5000 | 1.51       |
| 5.8 L King Cobra EFI | 4600-5000 | 1.43       |
| 7.4 L King Cobra     | 4200-4600 | 1.42       |
| 7.4 L King Cobra     | 4200-4600 | 1.63       |
| 7.4 L King Cobra EFI | 4200-4600 | 1.42       |

## SUZUKI® RPM CHART

| HP/Model   | Years     | WOT RPM   | Gear Ratio |
|------------|-----------|-----------|------------|
| DF 9.9     | 1997-2000 | 4500-5500 | 1.92       |
| DF 9.9     | 2001-2008 | 5400-6000 | 1.92       |
| DF 9.9     | 2009      | 4900-5500 | 2.08       |
| DF 9.9     | 2010 Thru | 5200-6200 | 2.08       |
| DF 15      | 1997-2001 | 5400-6000 | 1.92       |
| DF 25      | 2000-2009 | 4700-5300 | 2.27       |
| DF 25      | 2010 Thru | 4500-5500 | 2.09       |
| DF 30      | 2000-2007 | 5500-6100 | 2.27       |
| DF 40      | 1999-2009 | 5200-5800 | 2.27       |
| DF 40      | 2010 Thru | 5000-6000 | 2.27       |
| DF 50      | 1999-2009 | 5900-6500 | 2.27       |
| DF 50      | 2010 Thru | 5300-6300 | 2.27       |
| DF 60      | 1998-2009 | 4700-5300 | 2.42       |
| DF 60      | 2010 Thru | 5300-6300 | 2.27       |
| DF 70      | 1998-2008 | 5200-5800 | 2.42       |
| DF 70A     | 2009 Thru | 5000-6000 | 2.59       |
| DF 80A     | 2009 Thru | 5000-6000 | 2.59       |
| DT 85      | 1991-2000 | 5000-5600 | 2.08       |
| DF 90      | 2001-2008 | 4500-5500 | 2.59       |
| DF 90A     | 2009 Thru | 5300-6300 | 2.59       |
| DT 100     | 1991-2000 | 5250-5750 | 2.08       |
| DF 115     | 2001 Thru | 5000-6000 | 2.59       |
| DF 140     | 2002 Thru | 5600-6200 | 2.59       |
| DT 150 EFI | 1995-2003 | 4500-5500 | 1.86       |
| DF 150     | 2006 Thru | 5000-6000 | 2.50       |
| DF 175     | 2006 Thru | 5500-6100 | 2.50       |
| DF 200     | 2004 Thru | 5000-6000 | 2.29       |
| DF 225     | 2004 Thru | 5000-6000 | 2.29       |
| DF 250     | 2004 Thru | 5500-6100 | 2.29       |
| DF 300     | 2007 Thru | 5700-6300 | 2.08       |

## VOLVO® RPM CHART

| HP/Model | Years     | WOT RPM   | Gear Ratio  |
|----------|-----------|-----------|-------------|
| 3.0L GL  | 1994      | 4200-4600 | 1.85        |
| 3.0L GS  | 1994 Thru | 4200-4600 | 1.97 / 2.18 |
| 3.0L GXi | 2010      | 4400-4800 | -           |
| 4.3L GL  | 1994 Thru | 4200-4600 | -           |
| 4.3L GS  | 1994-1999 | 4400-4800 | -           |
| 4.3L Gi  | 1996-2002 | 4400-4800 | -           |
| 4.3L GXi | 2002 Thru | 4400-4800 | -           |
| 5.0L FL  | 1994 Thru | 4200-4600 | 1.66        |
| 5.0L Fi  | 1994 Thru | 4200-4600 | 1.66        |
| 5.0L GL  | 1998 Thru | 4400-4800 | 1.51 / 1.60 |
| 5.0L Gi  | 1998-1999 | 4400-4800 | 1.51 / 1.60 |
| 5.0L Gi  | 2000-2002 | 4600-5000 | 1.51 / 1.60 |
| 5.0L GXi | 2002 Thru | 4600-5000 | 1.51 / 1.60 |
| 5.7L GL  | 1994-1996 | 4200-4600 | 1.60        |
| 5.7L GLi | 1997 Thru | 4200-4600 | 1.60        |
| 5.7L Gi  | 1996-1997 | 4200-4600 | 1.51        |
| 5.7L Gi  | 2002 Thru | 4600-5000 | 1.43        |
| 5.7L GS  | 1997      | 4200-4600 | 1.51        |
| 5.7L GS  | 1998 Thru | 4400-4800 | 1.51 / 1.43 |
| 5.7L GSi | 1997 Thru | 4600-5000 | 1.43        |
| 5.7L GXi | 2001 Thru | 4600-5000 | 1.43        |
| 5.8L FL  | 1994-1997 | 4000-4400 | 1.51        |
| 5.8L FSi | 1995      | 4600-5000 | 1.43        |
| 5.8L FSi | 1996-1997 | 4200-4600 | 1.51        |
| 7.4L GL  | 1997      | 4200-4600 | 1.43        |
| 7.4L Gi  | 1997-2001 | 4200-4600 | 1.43        |
| 7.4L GSi | 1997      | 4800-5200 | 1.43        |
| 8.2L GSi | 1997      | 4600-5000 | 1.43        |

## YAMAHA® RPM CHART









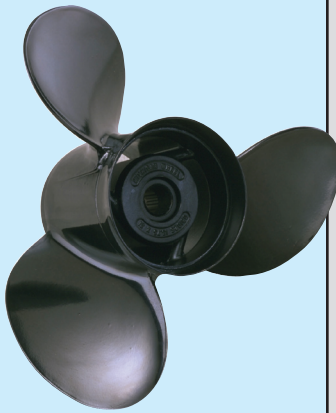

| HP/Model      | Years     | WOT RPM   | Gear Ratio |
|---------------|-----------|-----------|------------|
| 6 HP 4-Stroke | 1986 Thru | 4500-5500 | 2.08       |
| 8 HP          | 1986 Thru | 4500-5500 | 2.08       |
| 8 HP 4-Stroke | 1986 Thru | 5000-6000 | 2.08       |
| 9.9 HP        | 1984 Thru | 4500-5500 | 2.08       |
| F9.9 4-Stroke | 1986-2007 | 4500-5500 | 2.08       |
| F9.9 4-Stroke | 2008 Thru | 5000-6000 | 2.08       |
| 15 HP         | 1984 Thru | 4500-5500 | 2.08       |
| F15 4-Stroke  | 2000-2006 | 4500-5500 | 2.08       |
| F20 4-Stroke  | 2007 Thru | 5000-6000 | 2.08       |
| 25 HP         | 1988 Thru | 4500-5500 | 2.08       |
| F25 4-Stroke  | 1998-2006 | 5000-6000 | 2.08       |
| F25 4-Stroke  | 2010 Thru | 5000-6000 | 2.08       |
| 30 HP         | 1979-2002 | 4500-5500 | 1.85       |
| F30 4-Stroke  | 2001-2005 | 5000-6000 | 2.00       |
| 40 HP         | 1984 Thru | 4500-5500 | 1.85       |
| F40 4-Stroke  | 1999 Thru | 5000-6000 | 2.00       |
| 50 HP         | 1984 Thru | 4500-5500 | 1.85       |
| F50 4-Stroke  | 1995 Thru | 5000-6000 | 1.85       |
| 55 HP         | 1976-1995 | 4500-5500 | 1.84       |
| 60 HP         | 1976-1991 | 4500-5500 | 2.33       |
| F60 4-Stroke  | 1999 Thru | 5000-6000 | 1.85       |
| 70 HP         | 2000 Thru | 5000-6000 | 2.33       |
| F75 4-Stroke  | 2003 Thru | 5000-6000 | 2.31       |
| F80 4-Stroke  | 1999-2002 | 5000-6000 | 2.31       |
| 85 HP         | 1991-1997 | 4500-5500 | 2.00       |
| 90 HP         | 1984 Thru | 4500-5500 | 2.00       |
| F90 4-Stroke  | 1999 Thru | 4500-5500 | 2.00       |
| F100 4-Stroke | 1999 Thru | 5000-6000 | 2.31       |
| 115 HP        | 1994 Thru | 4500-5500 | 2.00       |
| F115 4-Stroke | 2000 Thru | 5000-6000 | 2.15       |
| 130 HP        | 2001-2003 | 5000-6000 | 2.00       |
| F150 4-Stroke | 2004 Thru | 5000-6000 | 2.00       |
| 175 HPDI      | 2007 Thru | 4500-5500 | 1.86       |
| 200 HPDI      | 1984 Thru | 4500-5500 | 1.86       |
| F200 4-Stroke | 2002 Thru | 5000-6000 | 2.00       |
| 225 HP        | 2006 Thru | 5000-6000 | 1.75       |
| F225 4-Stroke | 2002 Thru | 5000-6000 | 2.00       |
| F225 Offshore | 2010 Thru | 5000-6000 | 1.75       |
| F250 4-Stroke | 2002 Thru | 5000-6000 | 2.00       |
| F250 Offshore | 2010 Thru | 5000-6000 | 1.75       |

## YAMAHA® V MAX RPM CHART

| HP/Model                    | WOT RPM   | Gear Ratio |
|-----------------------------|-----------|------------|
| V Max 150 HPDI              | 4500-5500 | 2.00       |
| V Max 150 TRP               | 4500-5500 | 2.00       |
| V Max 150                   | 4500-5500 | 2.00       |
| V Max 150 EFI               | 4500-5500 | 2.00       |
| V Max 175                   | 4500-5500 | 1.86       |
| V Max 175 HPDI              | 4500-6000 | 1.86       |
| V Max 200 HPDI              | 4500-5500 | 1.86       |
| V Max 200 3.1 EFI           | 4500-5500 | 1.81       |
| V Max 200 3.3 HPDI Series 2 | 5000-6000 | 1.81       |
| VF 200 V Max SHO 4-Stroke   | 5000-6000 | 1.75       |
| VF 225 V Max SHO 4-Stroke   | 5000-6000 | 1.75       |
| V Max 225 3.1 EFI           | 4500-5500 | 1.81       |
| V Max 225 3.3 HPDI Series 2 | 5000-6000 | 1.75       |
| V Max 250 3.1 EFI           | 4500-5500 | 1.81       |
| V Max 250 3.3 HPDI Series 2 | 5000-6000 | 1.75       |
| VF 250 V Max SHO 4-Stroke   | 5000-6000 | 1.75       |
| V Max 300 3.3 HPDI Series 2 | 4500-6000 | 1.75       |

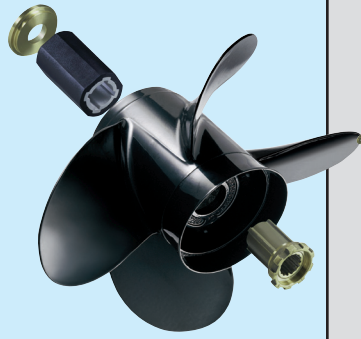
Engine RPM Chart is for reference only. Please consult Owner's Manual to confirm specifications.

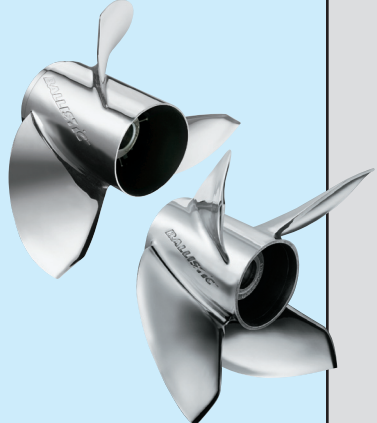



# 2012 MICHIGAN PROPELLERS

|   |  | INFLATABLE  | ALUMINUM  | BASS BOAT   | BAY BOAT  |
|---|--|---|---|---|---|
| <p><b>MICHIGAN MATCH®</b></p> <p>We pass the savings on to you in the form of a high quality, better-performing propeller that typically costs less than the engine manufacturer propeller you're replacing. Every Michigan Match propeller features a NAVAL brass spindle with rubber cushioned hub which absorbs impact and the stress caused by shifting gears. The rubber bushing is designed to spin free under significant impact, reducing the potential for lower unit damage. Great primary propeller, yet priced as a weekend-saver spare!</p> <ul style="list-style-type: none"> <li>• <i>Improved powder coating and beefier bushing</i></li> <li>• <i>Perfect replacement propeller</i></li> <li>• <i>Available in aluminum</i></li> </ul> |    |    |    |   |   |
| <p><b>VORTEX® 3-BLADE</b></p> <p>High performance aluminum propeller utilizing the XHS® / XHS II® Xchangeable Hub System. Featuring high performance blade geometry, precision balanced blades, high gloss powder coat and interchangeability with the Mercury Flo-Torq® II system, the Vortex® XHS® / XHS II® is a great choice for a replacement or spare propeller for boaters.</p> <ul style="list-style-type: none"> <li>• <i>V6/V8 applications (15" - 23" pitch)</i></li> <li>• <i>V4 applications (10"-21" pitch)</i></li> <li>• <i>20-70 HP applications (9"-17" pitch)</i></li> <li>• <i>Available in aluminum, RH rotations</i></li> </ul>   |   |    |    |   |   |
| <p><b>VORTEX® 4-BLADE</b></p> <p>For quicker planing, improved handling and acceleration. These Vortex® 4-Blade aluminum propellers are a great alternative to a comparable 3-Blade propeller, offering enhanced performance when towing water skiers, tubers, knee and wakeboarders.</p> <p>Just like the 3-Blade, Vortex® 4-Blade propellers feature high performance blade geometry, precision balanced blades, high gloss powder coat, and interchangeability with Mercury Flo-Torq® II.</p> <ul style="list-style-type: none"> <li>• <i>V6/V8 applications (16", 18", 20" pitch)</i></li> <li>• <i>20-70 HP applications (8"-10" pitch)</i></li> <li>• <i>Available in aluminum, RH rotations</i></li> </ul>                                       |  |  |  |   |   |
| <p><b>BALLISTIC® 3-BLADE &amp; 4-BLADE</b></p> <p>High performance stainless steel propellers with the proven Power Tip for peak efficiency. Blade tip and cup combine to improve bite and reduce power losses caused by cavitation. Highly cambered blade sections provide for higher speed and better bow lift.</p> <ul style="list-style-type: none"> <li>• <i>Tapered leading edges minimize drag</i></li> <li>• <i>Performance characteristics of racing style propellers</i></li> <li>• <i>Maintains optimum blade strength and thickness</i></li> <li>• <i>Available in stainless steel, RH &amp; LH rotations</i></li> </ul>  |  |   |   |  |  |

# 2012 MICHIGAN PROPELLERS







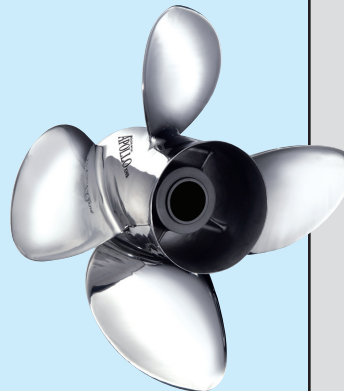
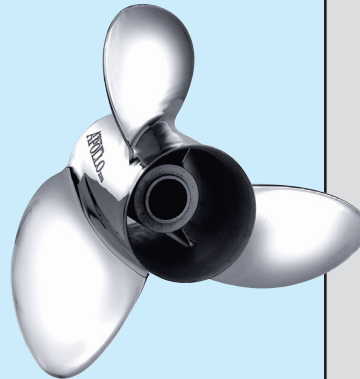
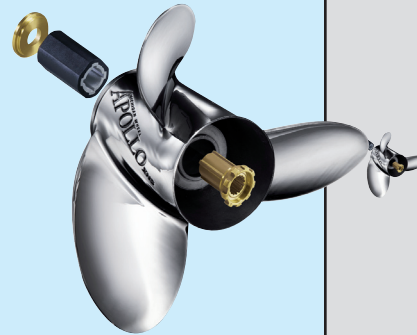

|  | FLATS BOAT   | WALLEYE BOAT  | OFFSHORE SINGLE   | OFFSHORE DUAL | SPORT BOAT SINGLE   | SPORT BOAT DUAL   | PONTOON   | SKI BOAT  | FAMILY CRUISER  | HOUSEBOAT   | WORKBOAT  |
|--|--|---|---|---------------|---|---|---|---|---|---|---|
|  |  |    |    |               |   |   |    |    |    |  |  |
|  |  |    |    |               |   |   |    |    |    |   |   |
|  |  |  |  |               |   |   |  |  |  |   |   |
|  |  |   |   |               |  |  |   |  |   |   |   |

# 2012 MICHIGAN PROPELLERS

|  | INFLATABLE | ALUMINUM  | BASS BOAT   | BAY BOAT  |
|--|------------|---|---|---|
| <p><b>APOLLO® 3-BLADE</b></p> <p>Apollo® propellers are highly polished, ultimate performance, stainless steel wheels. Apollo® is designed to use Michigan Wheel's XHS® / XHS II® hub system, and is interchangeable with Mercury's Flo-Torq® II hub system.</p> <p>Standard 3-Blade propeller can be utilized on typical outboard and sterndrive applications.</p> <ul style="list-style-type: none"> <li>• 30-70 HP (12" - 15", RH rotation)</li> <li>• V4 Outboard (15" - 21" pitch, RH &amp; LH rotations)</li> <li>• V6/V8 OBSD (15" - 23" pitch, RH &amp; LH rotations)</li> <li>• Available in stainless steel</li> </ul> |            |    |  |   |
| <p><b>APOLLO® 3-BLADE LG DIAMETER</b></p> <p>The Apollo® 3-Blade Large Diameter propeller is great for heavier applications that require increased blade area. Common to the entire Apollo® line, the Apollo® Large Diameter 3-Blade features CAD designed high performance blade geometry.</p> <ul style="list-style-type: none"> <li>• V6/V8 OBSD (17" - 23" pitch, RH &amp; LH rotations)</li> <li>• Available in stainless steel</li> </ul>  |            |   |   |    |
| <p><b>APOLLO® 4-BLADE</b></p> <p>The Apollo® 4-Blade propeller is designed to improve hole shot on heavier loads. This propeller is ideal for pulling/towing in water sports. High performance blade geometry, high luster finish, utilization of the XHS® / XHS II® hub kit, and interchangeability with Mercury's Flo-Torq® II hub system makes the Apollo® 4-Blade the perfect propeller for a wide range of boats.</p> <ul style="list-style-type: none"> <li>• V6/V8 OBSD (16" - 22" pitch, RH &amp; LH rotations)</li> <li>• Available in stainless steel</li> </ul>   |            |  |   |  |



# 2012 MICHIGAN PROPELLERS

|  | FLATS BOAT   | WALLEYE BOAT  | OFFSHORE SINGLE   | OFFSHORE DUAL   | SPORT BOAT SINGLE   | SPORT BOAT DUAL   | PONTOON   | SKI BOAT  | FAMILY CRUISER  | HOUSEBOAT   | WORKBOAT  |
|--|--|---|---|---|---|---|---|---|---|---|---|
|  |  |   |   |   |    |    |   |   |   |   |   |
|  |  |   |    |    |    |    |  |   |  |  |  |
|  |  |  |  |  |  |  |   |  |   |   |   |

# SKI & TOWBOAT PROPELLERS

Michigan Wheel Marine, the leader in propeller manufacturing technology, presents Ambush® towboat propellers. These propellers are 100% CNC machined for the ultimate in accuracy and consistency.

Michigan Wheel Marine developed the CNC machining process for propellers in the mid-1980's and revolutionized the way propellers became manufactured worldwide. Originally, the CNC machining technology was used to manufacture custom propellers for large mega-yachts where accuracy is critical and design geometry is complex.

Now, that same technology is being used to provide the best towboat propeller on the market.

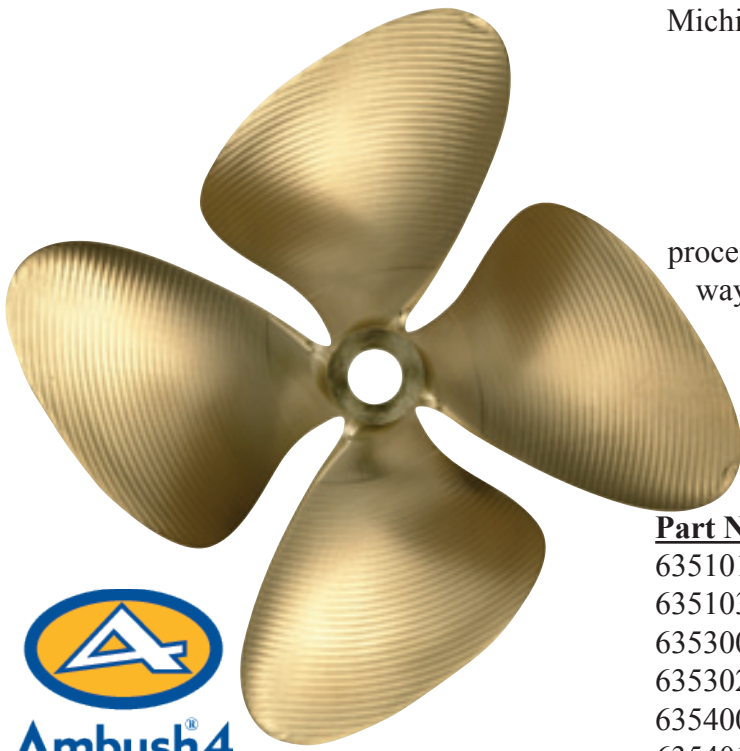

| Part Number | Dia. x Pitch | Rotation | Bore   |
|-------------|--------------|----------|--------|
| 635101      | 13 x 13      | LH       | 1"     |
| 635103      | 13 x 13      | LH       | 1-1/8" |
| 635300      | 13 x 16      | RH       | 1"     |
| 635302      | 13 x 16      | RH       | 1-1/8" |
| 635400      | 14 x 18      | RH       | 1"     |
| 635401      | 14 x 18      | LH       | 1"     |
| 635402      | 14 x 18      | RH       | 1-1/8" |
| 635403      | 14 x 18      | LH       | 1-1/8" |
| 635404      | 14 x 18      | RH       | 1-1/4" |
| 635405      | 14 x 18      | LH       | 1-1/4" |
| 635443      | 14 x 20      | LH       | 1-1/8" |

Michigan Wheel Marine's Federal Series ski boat propellers provide consistent response to your throttle commands. The 3-Blade Dyna-Jet Cupped Propellers are made of a NiBrAl alloy which provides extra strength, less flex, and greater durability. All are cupped to minimize the performance draining effects of cavitation.

| Part Number | Dia. x Pitch | Rotation | Bore   |
|-------------|--------------|----------|--------|
| 310649      | 13 x 12      | LH       | 1"     |
| 310625      | 13 x 12-1/2  | LH       | 1-1/8" |
| 310660      | 13 x 13      | RH       | 1"     |
| 310661      | 13 x 13      | LH       | 1"     |
| 310659      | 13 x 13      | LH       | 1-1/8" |
| 310705      | 13 x 13-1/2  | LH       | 1-1/8" |
| 310724      | 13 x 14      | RH       | 1"     |
| 310725      | 13 x 14      | LH       | 1"     |
| 310727      | 13 x 14      | LH       | 1-1/8" |
| 310763      | 13 x 15      | LH       | 1"     |
| 310765      | 13 x 15      | LH       | 1-1/8" |
| 310801      | 13 x 15-1/2  | LH       | 1-1/8" |
| 310836      | 13 x 17      | RH       | 1"     |
| 311244      | 14 x 15      | RH       | 1"     |
| 311284      | 14 x 16      | RH       | 1"     |
| 311360      | 14 x 18      | RH       | 1-1/8" |
| 311361      | 14 x 18      | LH       | 1-1/8" |

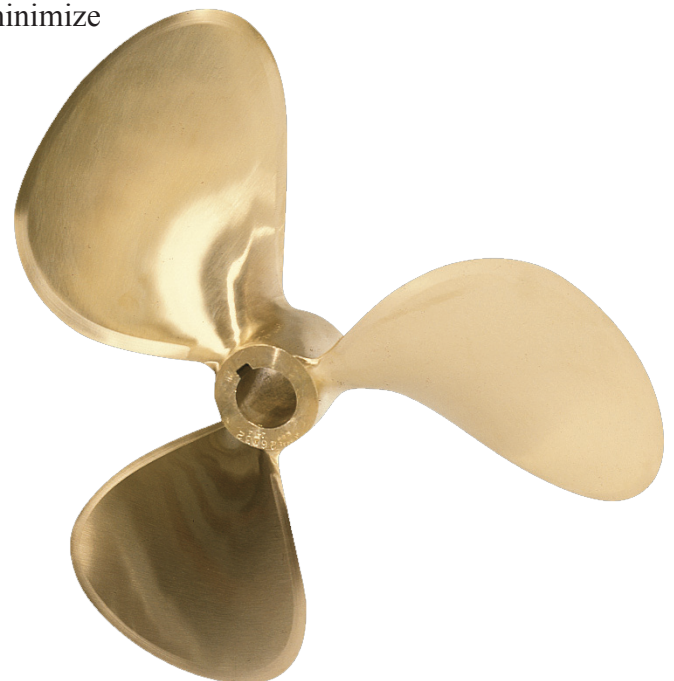

**DYNA-JET CUPPED**

# HOW TO USE THE APPLICATION GUIDE

- If original equipment part number (OEM) is known and a size or style change is not desired, then refer to Part Number Cross Reference on Pages B2-B33 to locate the equivalent Michigan propeller.
- If an original part number is not known, the part number can not be found in the Part Number reference, or a propeller size or style change is desired, use the following procedure for selecting a propeller.

1. Locate the brand of outboard or sterndrive engine using the table of contents.
2. Locate the **HORSEPOWER/MODEL** and **YEAR** that corresponds with the engine brand.
3. Find the range of your **BOAT LENGTH**, and the boat use that best describes your vessel and usage.
4. Select the propeller **DIAMETER/PITCH** that best meets your vessel and usage. Refer to pages A2-A6 for information on choosing the right propeller.
5. Order the propeller using the **MICHIGAN PART NUMBER**. (If aluminum is desired, read across to the correct column for the part number. If stainless steel is desired, read across to the correct column for part number.)
6. If **VORTEX**<sup>®</sup>, or **APOLLO**<sup>®</sup> propellers are selected, the **XHS**<sup>®</sup> / **XHS II**<sup>®</sup> **HUB KIT** indicated must be ordered.
7. Carefully read ALL notes for additional important attachment information. (If specific to a propeller, it will be noted next to the part number.)

*Unless otherwise noted: The XHS<sup>®</sup> / XHS II<sup>®</sup> hub kit is sold separately from the propeller. See pages 40-41 for XHS<sup>®</sup> / XHS II<sup>®</sup> hub kit and miscellaneous hardware information. Vortex<sup>®</sup> and Apollo<sup>®</sup> propellers fit existing Mercury Flo-Torg<sup>®</sup> II hubs. Check existing hub for wear or damage and replace if necessary with Michigan Wheel XHS<sup>®</sup> / XHS II<sup>®</sup> hub.*



**NOTE:** This is a "general" application guideline for determining the appropriate propeller size for your vessel. Performance characteristics may vary due to the many kinds of boats, hull styles, loads and style of boating.

## MERCURY<sup>®</sup>, MARINER<sup>®</sup>, SEA RAY<sup>®</sup> OUTBOARD

### 40-140 HORSEPOWER • 4-1/4" GEARCASE

Thru Hub Exhaust & 15 Tooth Spline

|   |   |  |
|---|---|--|
| 40 & 50 HP 4-Stroke / Bigfoot ..... All Years | 75 HP 4-Stroke ..... 2001 & Newer             | 90 HP 4-Stroke ..... 2001 & Newer                  |
| 60 HP 4-Stroke / Bigfoot ..... 1995 & Newer   | 80 HP ..... 1978-1989                         | 100 HP ..... 1988 & Newer                          |
| 60 HP (Sea Pro/Marathon) ..... 1995 & Newer   | 80 HP (Mariner <sup>®</sup> ) ..... 1978-1983 | 115 HP (Yamaha <sup>®</sup> ) ..... 1978-1983      |
| 65 HP (Model 650 - 2 Cyl.) ..... Thru 1971    | 80 HP (Model 800; 2 & 4 Cyl.) ..... Thru 1977 | 115 HP 4-Stroke ..... 2001 & Newer                 |
| 65 HP (Model 650 - 4 Cyl.) ..... 1961-1970    | 80 HP (Yamaha <sup>®</sup> ) ..... 1977-1983  | 125 HP ..... 1994-2005                             |
| 70 HP ..... 1987-1989                         | 85 HP (Model 850; 2 & 4 Cyl.) ..... Thru 1977 | 140 HP (Includes Sea Pro/Offshore) ..... 1978-1981 |
| 75 HP (Sea Pro/Marathon) ..... All Years      | 90 HP (Yamaha <sup>®</sup> ) ..... 1978-1983  | 140 HP (Yamaha <sup>®</sup> ) ..... 1978-1979      |
| 75 HP 2-Stroke ..... 1984-2005                | 90 HP 2-Stroke ..... 1978 & Newer             | Models 900-1150-1500 ..... Thru 1977               |



| Boat Description/Length | <br>ALUMINUM PROPELLERS |      |       |      |              |              | <br>STAINLESS STEEL PROPELLERS |      |       |      |              |          |
|-------------------------|--|------|-------|------|--------------|--------------|---|------|-------|------|--------------|----------|
|                         | Dia.   | Rot. | Pitch | Bld# | OEM Part No. | Part No.     | Dia.  | Rot. | Pitch | Bld# | OEM Part No. | Part No. |
|                         | 25' & Up - AL  | 14   | R     | 10   | 3            | 48-854342A45 | 992109  |      |       |      |              |          |
| 25' & Up - AL           | 14   | R    | 13    | 3    | 48-77340A45  | 992112       |   |      |       |      |              |          |
| 19'-24' - AL, SK        | 13-3/4   | R    | 15    | 3    | 48-77342A45  | 992113       | 13-3/8  | R    | 15    | 3    |              | 993143   |
| 19'-24' - AL, SK        |  |      |       |      |              |              | 13-3/8  | L    | 15    | 3    |              | 993153   |
| 17'-20' - AL, SK        | 13-1/4   | R    | 17    | 3    | 48-77344A45  | 992114       | 13-1/4  | R    | 17    | 3    |              | 993144   |
| 17'-20' - AL, SK        |  |      |       |      |              |              | 13-1/4  | L    | 17    | 3    |              | 993154   |
| 16'-19' - AL, SK        | 13   | R    | 19    | 3    | 48-77346A45  | 992115       | 13-1/8  | R    | 19    | 3    |              | 993145   |
| 16'-19' - AL, SK        |  |      |       |      |              |              | 13-1/8  | L    | 19    | 3    |              | 993155   |
| 15'-18' - AL, SK        | 12-3/4   | R    | 21    | 3    | 48-77348A45  | 992116       | 13  | R    | 21    | 3    |              | 993146   |
| 15'-18' - AL, SK        |  |      |       |      |              |              | 13  | L    | 21    | 3    |              | 993156   |

Drop-In Hub

Use XHS II<sup>®</sup> Hub Kit 202

USE Gearcase Adapter Ring supplied with propeller.

Refer to Pages 40-41 for Details of Hub Kit Components.

| Boat Description/Length | <br>ALUMINUM PROPELLERS |      |       |      |              |          | <br>STAINLESS STEEL PROPELLERS |      |       |          |                      |        |       |          |        |
|-------------------------|--|------|-------|------|--------------|----------|---|------|-------|----------|----------------------|--------|-------|----------|--------|
|                         | Dia.   | Rot. | Pitch | Bld# | OEM Part No. | Part No. | 3-BLADE BALLISTIC   |      |       |          | 3-BLADE BALLISTIC XL |        |       |          |        |
|                         |  |      |       |      |              |          | Dia.  | Rot. | Pitch | Part No. | Dia.                 | Rot.   | Pitch | Part No. |        |
| Pontoon                 | 14   | R    | 12    | 3    |              | 031201   |   |      |       |          |                      |        |       |          |        |
| 22' & Up - AL           | 14   | R    | 13    | 3    | 48-77340A45  | 031055   |   |      |       |          |                      |        |       |          |        |
| Pontoon                 | 14   | R    | 13    | 3    | 48-77340CP1  | 031102   |   |      |       |          |                      |        |       |          |        |
| 19'-24' - AL, SK        | 13-3/4   | R    | 15    | 3    | 48-77342A45  | 031041   | 13-5/8  | R    | 15    |          | 335130               |        |       |          |        |
| 17'-20' - AL, SK        | 13-1/4   | R    | 17    | 3    | 48-77344A45  | 031042   | 13-1/2  | R    | 17    |          | 335131               |        |       |          |        |
| 16'-19' - AL, SK        | 13   | R    | 19    | 3    | 48-77346A45  | 031043   | 13-3/8  | R    | 19    |          | 335132               |        |       |          |        |
| 15'-18' - AL, SK        | 12-3/4   | R    | 21    | 3    | 48-77348A45  | 031144   | 13-1/8  | R    | 21    |          | 335133               |        |       |          |        |
| High Performance        | 12-1/2   | R    | 23    | 3    | 48-77350A45  | 031045   |   |      |       |          |                      | 13-1/2 | R     | 22       | 335134 |

Rubber Hub Bushing

Use OEM Fwd Washer 13191A1 Tab Washer 11-816629 or MWM Kit 990332 or 9660-1

See Page 24 for details.

Ⓢ Limited Inventory Item.

\* To avoid damage or injury, replace standard trim tab with trim tab 822777A1.

Ⓢ Pontoon Boat Propeller (Extended Cup)

**4-8 HORSEPOWER**

Non-Thru Hub Exhaust & Pin Drive

|                              |                             |                      |
|------------------------------|-----------------------------|----------------------|
| 4 HP.....1980-1983           | 6 HP.....1986-2005          | 7.5 HP.....1980-1983 |
| 4, 5 HP Deluxe.....1986-1995 | 6 HP 4-Stroke.....1998-2003 | 8 HP.....1986-2005   |
| 5 HP 4-Stroke.....1999-2003  |                             |                      |

|                         | <br><b>ALUMINUM PROPELLERS</b> |      |       |      |              |               |
|-------------------------|---|------|-------|------|--------------|---------------|
| Boat Description/Length | Dia.  | Rot. | Pitch | Bld# | OEM Part No. | Part No.      |
| Standard Replacement    | 8-1/2   | R    | 9     | 3    | 778797       | <b>012032</b> |

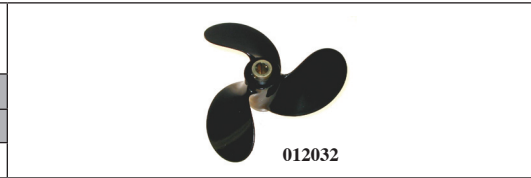

Rubber Hub Bushing

**6-15 HORSEPOWER**

Non-Thru Hub Exhaust & Pin Drive

|                      |                                |                          |
|----------------------|--------------------------------|--------------------------|
| 6 HP.....1966-1979   | 10 HP.....1958-1963            | 8-15 HP.....2000 & Newer |
| 9.5 HP.....1964-1973 | 10, 12, 14 HP***.....1982-1994 |                          |

|                         | <br><b>ALUMINUM PROPELLERS</b> |      |       |      |              |               |
|-------------------------|---|------|-------|------|--------------|---------------|
| Boat Description/Length | Dia.  | Rot. | Pitch | Bld# | OEM Part No. | Part No.      |
| 14'-16' - AL            | 8-1/4   | R    | 8     | 3    |              | <b>012008</b> |
| 12'-14' - LL            | 8   | R    | 7-1/4 | 2    | 763588       | <b>012005</b> |
| 12'-14' - LL            | 8-1/4   | R    | 8-1/2 | 3    | 763586       | <b>012007</b> |



Rubber Hub Bushing

**8, 9.9-15 HORSEPOWER • 2-1/2" GEARCASE**

Thru Hub Exhaust & 13 Tooth Spline

|  |                                |                                   |
|--|--------------------------------|-----------------------------------|
| 9.9-15 HP (Non 4-Stroke).....1974-2005 | 8 HP 4-Stroke.....1996 & Newer | 9.9, 15 HP 4-Stroke.....1995-2001 |
|--|--------------------------------|-----------------------------------|

|                         | <br><b>ALUMINUM PROPELLERS</b> |      |       |      |              |               |
|-------------------------|--|------|-------|------|--------------|---------------|
| Boat Description/Length | Dia.   | Rot. | Pitch | Bld# | OEM Part No. | Part No.      |
| 14'-16' - AL            | 10   | R    | 7     | 3    | 763456       | <b>012112</b> |
| Standard Replacement    | 9-1/2  | R    | 10    | 3    | 778772       | <b>012111</b> |



Rubber Hub Bushing

**9.9-15 HORSEPOWER (4-STROKE) • 2-1/2" GEARCASE**

Thru Hub Exhaust & 10 Tooth Spline

|                                  |                                 |
|----------------------------------|---------------------------------|
| 9.9 HP 4-Stroke.....2002 & Newer | 15 HP 4-Stroke.....2002 & Newer |
|----------------------------------|---------------------------------|

|                         | <br><b>ALUMINUM PROPELLERS</b> |      |       |      |              |               |
|-------------------------|---|------|-------|------|--------------|---------------|
| Boat Description/Length | Dia.  | Rot. | Pitch | Bld# | OEM Part No. | Part No.      |
| 14'-18' - AL            | 9-1/4   | R    | 9     | 3    | 5005384      | <b>062016</b> |



Rubber Hub Bushing



**10-25 HORSEPOWER**

Non-Thru Hub Exhaust & Pin Drive

10 HP.....1951-1957                      18 HP.....1957-1973                      25 HP.....1969-1977  
 15 HP.....1953-1956                      20 HP.....1969-1973

| Boat Description/Length | <br>ALUMINUM PROPELLERS |      |       |      |              |          |
|-------------------------|--|------|-------|------|--------------|----------|
|                         | Dia.   | Rot. | Pitch | Bld# | OEM Part No. | Part No. |
| CR, HB, SB              | 9-1/4  | R    | 7     | 3    | 388294       | 012102   |
| 14'-16' - HL            | 9  | R    | 9     | 3    | 763587       | 012109   |
| 12'-14' - LL            | 9  | R    | 10    | 3    | 763583       | 012011   |
| 12'-14' - LL            | 9-1/4  | R    | 11    | 3    |              | 012013   |



Rubber Hub Bushing

**14-28 HORSEPOWER**

Non-Thru Hub Exhaust & 13 Tooth Spline

14 HP.....1989                      25 HP\*\*.....1978-1991; 1994 & Newer                      28 HP.....1986-1996  
 25 HP.....1978-1984

| Boat Description/Length | <br>ALUMINUM PROPELLERS |      |       |      |              |          |
|-------------------------|--|------|-------|------|--------------|----------|
|                         | Dia.   | Rot. | Pitch | Bld# | OEM Part No. | Part No. |
| 16'-18' - HL            | 9  | R    | 9     | 3    | 763585       | 012021   |
| 15'-17' - AL            | 9  | R    | 10    | 3    | 763589       | 012015   |
| 14'-17' - AL            | 9-1/4  | R    | 11    | 3    | 763584       | 012016   |
| 14'-17' - LL            | 9-1/4  | R    | 12    | 3    | 763590       | 012030   |



Rubber Hub Bushing

**25-30 HORSEPOWER (4-STROKE) • 3" GEARCASE**

Thru Hub Exhaust & 10 Tooth Spline

25 HP 4-Stroke.....2004-2007                      30 HP 4-Stroke.....2004-2007

| Boat Description/Length | <br>ALUMINUM PROPELLERS |      |       |      |              |          |
|-------------------------|--|------|-------|------|--------------|----------|
|                         | Dia.   | Rot. | Pitch | Bld# | OEM Part No. | Part No. |
|                         | 10-1/2   | R    | 9     | 3    |              | 992501   |
|                         | 10-1/2   | R    | 10    | 3    |              | 992502   |
| 16'-18' - AL            | 10-1/2   | R    | 11    | 3    |              | 992503   |
| 14'-16' - AL            | 10-1/8   | R    | 12    | 3    |              | 992504   |
| 14'-16' - AL            | 10-1/8   | R    | 13    | 3    |              | 992505   |
|                         | 10-1/8   | R    | 14    | 3    |              | 992506   |



Drop-In Hub  
 Use XHS® Hub Kit  
**121**

MUST use Gearcase Adapter Ring supplied with propeller.

Refer to Pages 40-41 for Details on Hub Kit Components.

| Boat Description/Length | <br>STAINLESS STEEL PROPELLERS |      |       |      |              |          |
|-------------------------|---|------|-------|------|--------------|----------|
|                         | Dia.  | Rot. | Pitch | Bld# | OEM Part No. | Part No. |
| 14'-16' - AL            | 10-1/8  | R    | 13    | 3    |              | 305529   |
|                         | 10-1/8  | R    | 15    | 3    |              | 305530   |



Rubber Hub Bushing

EVINRUDE / JOHNSON

## 15-35 HORSEPOWER • 3" GEARCASE

Thru Hub Exhaust & 14 Tooth Spline • *Vortex® Propeller May Interfere with Skeg on Any Model*

|                                  |                                  |                               |
|----------------------------------|----------------------------------|-------------------------------|
| 15 HP E-Tec®.....2011 & Newer    | 25 HP 2 & 3 Cyl.....1984 & Newer | 30 HP E-Tec®.....2009 & Newer |
| 20 HP 2 Cyl.....1984-1997        | 25 HP E-Tec®.....2009 & Newer    | 35 HP 2 Cyl.....1979-1983     |
| 25 HP (Commercial).....1993-2005 | 30 HP 2 Cyl.....1984 & Newer     | 35 HP 3 Cyl.....1997-2001     |

| Boat Description/Length | <br><b>ALUMINUM PROPELLERS</b> |      |       |      |              |          |
|-------------------------|---|------|-------|------|--------------|----------|
|                         | Dia.  | Rot. | Pitch | Bld# | OEM Part No. | Part No. |
| 17'-20' - AL, SK        | 10-1/2  | R    | 9     | 3    |              | 992501   |
| 17'-20' - AL, SK        | 10-1/2  | R    | 10    | 3    |              | 992502   |
| 16'-18' - AL, SK        | 10-1/2  | R    | 11    | 3    | 765049       | 992503   |
| 16'-18' - AL, SK        | 10-1/8  | R    | 12    | 3    |              | 992504   |
| 15'-17' - AL, SK        | 10-1/8  | R    | 13    | 3    | 778863       | 992505   |
| 13'-15' - AL, SK        | 10-1/8  | R    | 14    | 3    |              | 992506   |

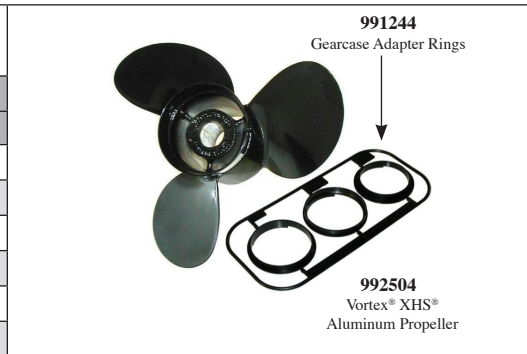



**Drop-In Hub**

Use XHS®  
Hub Kit  
**118**

MUST use Gearcase Adapter Ring supplied with propeller.

Refer to Pages 40-41 for Details on Hub Kit Components.

| Boat Description/Length | <br><b>ALUMINUM PROPELLERS</b> |      |       |      |              |          |
|-------------------------|---|------|-------|------|--------------|----------|
|                         | Dia.  | Rot. | Pitch | Bld# | OEM Part No. | Part No. |
| 17'-20' - AL, SK        | 11  | R    | 9     | 3    | 765048       | 012054   |
| 17'-20' - AL, SK        | 11  | R    | 9     | 3    | 386317       | ⊗ 011033 |
| 16'-18' - AL, SK        | 10-1/2  | R    | 11    | 3    | 765049       | 012055   |
| 15'-17' - AL, SK        | 10  | R    | 13    | 3    | 778863       | 012056   |
| 13'-15' - AL, SK        | 10  | R    | 15    | 3    | 763486       | 012057   |

| <br><b>STAINLESS STEEL PROPELLERS</b> |      |       |      |              |          |  |
|--|------|-------|------|--------------|----------|--|
| Dia.   | Rot. | Pitch | Bld# | OEM Part No. | Part No. |  |
| 10-1/8   | R    | 13    | 3    |              | 305029   |  |
| 10-1/8   | R    | 15    | 3    |              | 305030   |  |

**Rubber Hub Bushing**

## 25-40 HORSEPOWER

Non-Thru Hub Exhaust & Pin Drive

|                     |                     |                       |
|---------------------|---------------------|-----------------------|
| 25 HP.....1951-1955 | 33 HP.....1965-1970 | 40 HP.....1960-1976   |
| 28 HP.....1962-1964 | 35 HP.....1957-1959 | 40 HP**.....1978-1985 |
| 30 HP.....1956      |                     |                       |

| Boat Description/Length | <br><b>ALUMINUM PROPELLERS</b> |      |        |      |              |          |
|-------------------------|---|------|--------|------|--------------|----------|
|                         | Dia.  | Rot. | Pitch  | Bld# | OEM Part No. | Part No. |
| 17'-19' - AL, SK        | 10-3/8  | R    | 11-1/2 | 3    |              | 012023   |
| 14'-16' - AL, SK        | 10-1/2  | R    | 12     | 3    |              | 012024   |



**Rubber Hub Bushing**



 MICHIGAN MATCH REPLACEMENT PROPELLERS



 VORTEX XHS PERFORMANCE PROPELLERS



 APOLLO

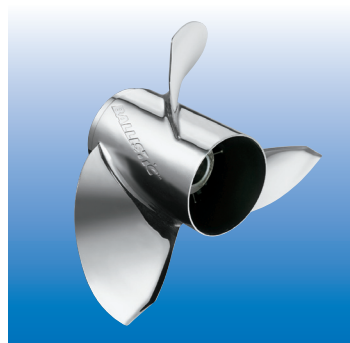

 BALLISTIC STAINLESS STEEL PROPS

Key to Abbreviations: LL = Light Loads; SB = Sailboat; AL = All Loads; SK = Skiboat; WB = Workboat; HB = Houseboat; CR = Cruisers; HL = Heavy Loads; WD = Weedless



⊗ Limited Inventory Item.

\*\* Commercial & Workhorse Application.



**40-50 HORSEPOWER (4-STROKE) • 3-1/4" GEARCASE**

Thru Hub Exhaust & 13 Tooth Spline

40 HP 4-Stroke .....1999-2005                      50 HP 4-Stroke ..... 1999-2005

|  |      |       |          |                      |      |       |          |         |      |  |          |        |      |       |      |              |          |
|---|------|-------|----------|----------------------|------|-------|----------|---------|------|---|----------|--------|------|-------|------|--------------|----------|
| ALUMINUM PROPELLERS   |      |       |          |                      |      |       |          |         |      | STAINLESS STEEL PROPELLERS  |          |        |      |       |      |              |          |
| 3-BLADE   |      |       |          | 3-BLADE LG. DIAMETER |      |       |          | 4-BLADE |      |   |          |        |      |       |      |              |          |
| Dia.  | Rot. | Pitch | Part No. | Dia.                 | Rot. | Pitch | Part No. | Dia.    | Rot. | Pitch   | Part No. | Dia.   | Rot. | Pitch | Bld# | OEM Part No. | Part No. |
|   |      |       |          |                      |      |       |          | 11-1/2  | R    | 8   | 992401   |        |      |       |      |              |          |
|   |      |       |          | 12-1/4               | R    | 9     | 992601   | 11-1/2  | R    | 9   | 992402   |        |      |       |      |              |          |
|   |      |       |          | 11-3/4               | R    | 10    | 992602   | 11-1/2  | R    | 10  | 992403   |        |      |       |      |              |          |
| 10-3/8  | R    | 11    | 992404   | 11-5/8               | R    | 11    | 992603   |         |      |   |          |        |      |       |      |              |          |
| 10-3/8  | R    | 12    | 992405   | 11-3/8               | R    | 12    | 992604   |         |      |   |          | 10-3/4 | R    | 12    | 3    |              | 993405   |
| 10-3/8  | R    | 13    | 992406   | 11-1/8               | R    | 13    | 992605   |         |      |   |          | 10-1/2 | R    | 13    | 3    | 777021       | 993406   |
| 10-3/8  | R    | 14    | 992407   | 11-1/4               | R    | 14    | 992606   |         |      |   |          | 10-3/8 | R    | 14    | 3    | 777022       | 993407   |
| 10  | R    | 15    | 992408   |                      |      |       |          |         |      |   |          | 10-1/8 | R    | 15    | 3    | 777023       | 993408   |
| 10  | R    | 16    | 992409   |                      |      |       |          |         |      |   |          |        |      |       |      |              |          |

|  |  |        |      |       |      |              |          |        |      |  |      |              |          |  |  |
|---|--|--------|------|-------|------|--------------|----------|--------|------|--|------|--------------|----------|--|--|
| ALUMINUM PROPELLERS   |  |        |      |       |      |              |          |        |      | STAINLESS STEEL PROPELLERS   |      |              |          |  |  |
| Boat Description/Length   |  | Dia.   | Rot. | Pitch | Bld# | OEM Part No. | Part No. | Dia.   | Rot. | Pitch  | Bld# | OEM Part No. | Part No. |  |  |
| 18'-21' - AL  |  | 12-1/4 | R    | 9     | 3    | 776807       | 032046   |        |      |  |      |              |          |  |  |
| 18'-21' - AL  |  | 11-3/4 | R    | 10    | 3    | 778606       | 032045   |        |      |  |      |              |          |  |  |
| 17'-19' - AL  |  | 11-5/8 | R    | 11    | 3    | 778607       | 032044   |        |      |  |      |              |          |  |  |
| 15'-17' - LL  |  | 11-3/8 | R    | 12    | 3    | 778608       | 032043   |        |      |  |      |              |          |  |  |
| 14'-16' - LL  |  | 11-1/8 | R    | 13    | 3    | 778609       | 032042   | 10-1/8 | R    | 13   | 3    |              | 395929   |  |  |
| 12'-14' - LL  |  | 11-1/4 | R    | 14    | 3    | 778610       | 032041   |        |      |  |      |              |          |  |  |
| 12'-14' - LL  |  | 11     | R    | 15    | 3    |              | 032040   | 10-1/8 | R    | 15   | 3    |              | 395930   |  |  |

Drop-In Hub  
Use XHS® Hub Kit  
**115**

Refer to Pages 40-41 for Details on Hub Kit Components.

Rubber Hub Bushing



**40-75 HORSEPOWER • SMALL (3-3/8") GEARCASE**

Thru Hub Exhaust & 13 Tooth Spline

40 HP 2 Cyl.....1984-2005                      55 HP ..... 1976-1979                      75 HP 3 Cyl. .... 1975-1985  
 48 HP..... 1987 & Newer                      65 HP 2 Cyl. .... 1980-1985                      Sprint/Formula E ..... 1986-1992  
 50 HP 2 Cyl.....1975-2005

|  |      |       |          |                      |      |       |          |         |      |       |          |      |      |       |      |              |          |
|---|------|-------|----------|----------------------|------|-------|----------|---------|------|-------|----------|------|------|-------|------|--------------|----------|
| ALUMINUM PROPELLERS   |      |       |          |                      |      |       |          |         |      |       |          |      |      |       |      |              |          |
| 3-BLADE   |      |       |          | LG. DIAMETER 3-BLADE |      |       |          | 4-BLADE |      |       |          |      |      |       |      |              |          |
| Dia.  | Rot. | Pitch | Part No. | Dia.                 | Rot. | Pitch | Part No. | Dia.    | Rot. | Pitch | Part No. | Dia. | Rot. | Pitch | Bld# | OEM Part No. | Part No. |
|   |      |       |          |                      |      |       |          | 11-1/2  | R    | 8     | 992401   |      |      |       |      |              |          |
|   |      |       |          |                      |      |       |          | 11-1/2  | R    | 9     | 992402   |      |      |       |      |              |          |
|   |      |       |          |                      |      |       |          | 11-1/2  | R    | 10    | 992403   |      |      |       |      |              |          |
| 11-3/4  | R    | 13    | 992301   | 12-1/2               | R    | 13    | 992311   |         |      |       |          |      |      |       |      |              |          |
| 11-3/4  | R    | 15    | 992302   | 12-1/4               | R    | 15    | 992312   |         |      |       |          |      |      |       |      |              |          |
| 11-3/4  | R    | 17    | 992303   |                      |      |       |          |         |      |       |          |      |      |       |      |              |          |

|  |  |        |      |       |      |              |          |        |      |  |      |              |          |  |  |
|---|--|--------|------|-------|------|--------------|----------|--------|------|--|------|--------------|----------|--|--|
| ALUMINUM PROPELLERS   |  |        |      |       |      |              |          |        |      | STAINLESS STEEL PROPELLERS   |      |              |          |  |  |
| Boat Description/Length   |  | Dia.   | Rot. | Pitch | Bld# | OEM Part No. | Part No. | Dia.   | Rot. | Pitch  | Bld# | OEM Part No. | Part No. |  |  |
| CR, HB  |  | 13     | R    | 11    | 3    | 763488       | 012036   |        |      |  |      |              |          |  |  |
| CR, HB  |  | 13     | R    | 11    | 3    |              | 011034   |        |      |  |      |              |          |  |  |
| 15'-18' - AL, SK  |  | 12-1/2 | R    | 13    | 3    | 763461       | 012037   |        |      |  |      |              |          |  |  |
| 15'-18' - AL, SK  |  | 12-1/2 | R    | 13    | 3    |              | 011035   |        |      |  |      |              |          |  |  |
| 14'-17' - AL, SK  |  | 12-1/4 | R    | 15    | 3    | 778774       | 011027   | 12-3/8 | R    | 15   | 3    |              | 325030   |  |  |
| 13'-15' - LL  |  | 11-3/4 | R    | 17    | 3    |              | 012039   | 12     | R    | 17   | 3    |              | 325031   |  |  |
| 13'-15' - LL  |  | 11-3/4 | R    | 17    | 3    | 763462       | 011028   |        |      |  |      |              |          |  |  |



Drop-In Hub  
Use XHS® Hub Kit  
**111**



Refer to Pages 40-41 for Details on Hub Kit Components.

Rubber Hub Bushing

## 40-75 HORSEPOWER • LARGE (4-1/4") GEARCASE

Thru Hub Exhaust & 13 Tooth Spline

|  |  |                                       |
|--|--|---------------------------------------|
| 40 HP E-Tec® .....2004 & Newer         | 55 HP 3 Cyl. ....1968-1969                     | 65 HP 3 Cyl. Pleasure .....1972-1973  |
| 45 HP 2 Cyl. Commercial .....1986-1995 | 55 HP 2 Cyl. Commercial .....1980 & Newer      | 65 HP 3 Cyl. Commercial.....1984-2001 |
| 50 HP E-Tec® .....2004 & Newer         | 55 HP E-Tec® .....2009 & Newer                 | 70 HP 3 Cyl. Commercial.....1974-2001 |
| 50 HP 2 Cyl. Commercial .....1977-1979 | 60 HP 3 Cyl. Pleasure.....1970-1971; 1986-2001 | 70 HP 4-Stroke .....1998 & Newer      |
| 50 HP 2 Cyl. Pleasure .....1971-1974   | 60 HP E-Tec® .....2004 & Newer                 | 75 HP 3 Cyl. Pleasure .....1975-1984  |
| 50 HP 3 Cyl. Pleasure .....1994-1998   | 60 HP 4-Stroke .....1998 & Newer               | 75 HP E-Tec® .....2004 & Newer        |

| Boat Description/Length |  |      |       |      |              |               |  |      |       |      |              |               |
|-------------------------|---|------|-------|------|--------------|---------------|---|------|-------|------|--------------|---------------|
|                         | ALUMINUM PROPELLERS   |      |       |      |              |               | STAINLESS STEEL PROPELLERS  |      |       |      |              |               |
|                         | Dia.  | Rot. | Pitch | Bld# | OEM Part No. | Part No.      | Dia.  | Rot. | Pitch | Bld# | OEM Part No. | Part No.      |
| CR, HB                  | 14  | R    | 10    | 3    |              | <b>992109</b> |   |      |       |      |              |               |
| 19'-22' - AL, SK        | 14  | R    | 13    | 3    | 765181       | <b>992112</b> |   |      |       |      |              |               |
| 17'-19' - AL, SK        | 13-3/4  | R    | 15    | 3    | 765182       | <b>992113</b> | 13-3/8  | R    | 15    | 3    | 763950       | <b>993143</b> |
| 17'-19' - AL, SK        |   |      |       |      |              |               | 13-3/8  | L    | 15    | 3    |              | <b>993153</b> |
| 15'-17' - AL, SK        | 13-1/4  | R    | 17    | 3    | 765183       | <b>992114</b> | 13-1/4  | R    | 17    | 3    | 763951       | <b>993144</b> |
| 15'-17' - AL, SK        |   |      |       |      |              |               | 13-1/4  | L    | 17    | 3    |              | <b>993154</b> |
| 14'-16' - AL, SK        | 13  | R    | 19    | 3    | 765184       | <b>992115</b> | 13-1/8  | R    | 19    | 3    | 763952       | <b>993145</b> |
| 14'-16' - AL, SK        |   |      |       |      |              |               | 13-1/8  | L    | 19    | 3    |              | <b>993155</b> |
| 13'-15' - AL, SK        | 12-3/4  | R    | 21    | 3    | 765185       | <b>992116</b> | 13  | R    | 21    | 3    |              | <b>993146</b> |
| 13'-15' - AL, SK        |   |      |       |      |              |               | 13  | L    | 21    | 3    |              | <b>993156</b> |

Note: For 60 HP & 70 HP 4-Stroke engine applications, 1998 & Newer, use XHS II® (Drop-In Hub) Kit # 210.  
For all other engine applications use XHS II® (Drop-In Hub) Kit # 206.



Drop-In Hub

Use XHS II® Hub Kit

**206 / 210**

Do NOT use Grease Adapter Ring supplied with propeller.

Refer to Pages 40-41 for Details on Hub Kit Components.

| Boat Description/Length |  |      |       |      |              |                 |  |      |       |      |              |               |
|-------------------------|---|------|-------|------|--------------|-----------------|---|------|-------|------|--------------|---------------|
|                         | ALUMINUM PROPELLERS   |      |       |      |              |                 | STAINLESS STEEL PROPELLERS  |      |       |      |              |               |
|                         | Dia.  | Rot. | Pitch | Bld# | OEM Part No. | Part No.        | Dia.  | Rot. | Pitch | Bld# | OEM Part No. | Part No.      |
| CR, HB                  | 14  | R    | 11    | 3    | 763301       | <b>012047</b>   |   |      |       |      |              |               |
| CR, HB                  | 14  | R    | 13    | 3    | 763302       | <b>* 011001</b> |   |      |       |      |              |               |
| 17'-19' - AL, SK        | 13-3/4  | R    | 15    | 3    | 763466       | <b>* 011002</b> | 13-5/8  | R    | 15    | 3    |              | <b>335030</b> |
| 15'-17' - AL, SK        | 13-1/4  | R    | 17    | 3    | 763463       | <b>* 011003</b> | 13-1/2  | R    | 17    | 3    |              | <b>335031</b> |
| 15'-17' - AL, SK        | 14  | R    | 17    | 3    | 763463       | <b>* 011024</b> |   |      |       |      |              |               |
| 14'-16' - AL, SK        | 13  | R    | 19    | 3    | 763464       | <b>* 011004</b> | 13-3/8  | R    | 19    | 3    |              | <b>335032</b> |
| 14'-16' - AL, SK        | 14  | R    | 19    | 3    | 763464       | <b>* 011025</b> |   |      |       |      |              |               |
| 13'-15' - AL, SK        | 12-3/4  | R    | 21    | 3    | 763465       | <b>* 011005</b> | 13-1/8  | R    | 21    | 3    |              | <b>335033</b> |

Rubber Hub Bushing





Key to Abbreviations: LL = Light Loads; SB = Sailboat; AL = All Loads; SK = Skiboat; WB = Workboat; HB = Houseboat; CR = Cruisers; HL = Heavy Loads; WD = Weedless

\* If currently using uncupped propeller, use cupped propeller having 2" less pitch. Boats with power trim use same pitch.



**85-140 HORSEPOWER • V-4 (4-1/4") GEARCASE**

Thru Hub Exhaust & 13 Tooth Spline

|   |  |                                |
|---|--|--------------------------------|
| 85 HP.....1969-1980; 1991-1995            | 110 HP.....1986-1989                           | 125 HP.....1971-1972           |
| 88 HP.....1981-1996                       | 112 HP.....1994-1996                           | 130 HP E-Tec®.....2004 & Newer |
| 90 HP.....1981 & Newer                    | 115 HP.....1973 & Newer                        | 135 HP.....1973-1976           |
| 90 HP E-Tec® Std. Length.....2004 & Newer | 115 HP E-Tec® (Includes H.O.).....2004 & Newer | 140 HP.....1977-1994           |
| 100 HP.....1979-1980; 1989-1993           | 120 HP.....1986-1994                           |                                |

| Boat Description/Length |  |      |       |      |              |               |  |      |       |      |              |               |
|-------------------------|---|------|-------|------|--------------|---------------|---|------|-------|------|--------------|---------------|
|                         | ALUMINUM PROPELLERS   |      |       |      |              |               | STAINLESS STEEL PROPELLERS  |      |       |      |              |               |
|                         | Dia.  | Rot. | Pitch | Bld# | OEM Part No. | Part No.      | Dia.  | Rot. | Pitch | Bld# | OEM Part No. | Part No.      |
| CR, HB                  | 14  | R    | 10    | 3    |              | <b>992109</b> |   |      |       |      |              |               |
| CR, HB                  | 14  | R    | 13    | 3    | 765181       | <b>992112</b> |   |      |       |      |              |               |
| 20'-24' - AL, SK        | 13-3/4  | R    | 15    | 3    | 765182       | <b>992113</b> | 13-3/8  | R    | 15    | 3    | 763950       | <b>993143</b> |
| 20'-24' - AL, SK        |   |      |       |      |              |               | 13-3/8  | L    | 15    | 3    |              | <b>993153</b> |
| 19'-22' - AL, SK        | 13-1/4  | R    | 17    | 3    | 765183       | <b>992114</b> | 13-1/4  | R    | 17    | 3    | 763951       | <b>993144</b> |
| 19'-22' - AL, SK        |   |      |       |      |              |               | 13-1/4  | L    | 17    | 3    |              | <b>993154</b> |
| 17'-19' - AL, SK        | 13  | R    | 19    | 3    | 765184       | <b>992115</b> | 13-1/8  | R    | 19    | 3    | 763952       | <b>993145</b> |
| 17'-19' - AL, SK        |   |      |       |      |              |               | 13-1/8  | L    | 19    | 3    |              | <b>993155</b> |
| 15'-18' - AL, SK        | 12-3/4  | R    | 21    | 3    | 765185       | <b>992116</b> | 13  | R    | 21    | 3    |              | <b>993146</b> |
| 15'-18' - AL, SK        |   |      |       |      |              |               | 13  | L    | 21    | 3    |              | <b>993156</b> |

| Boat Description/Length |  |      |       |      |              |               |  |      |       |               |                      |      |       |               |
|-------------------------|---|------|-------|------|--------------|---------------|---|------|-------|---------------|----------------------|------|-------|---------------|
|                         | ALUMINUM PROPELLERS   |      |       |      |              |               | 3-BLADE BALLISTIC   |      |       |               | 3-BLADE BALLISTIC XL |      |       |               |
|                         | Dia.  | Rot. | Pitch | Bld# | OEM Part No. | Part No.      | Dia.  | Rot. | Pitch | Part No.      | Dia.                 | Rot. | Pitch | Part No.      |
| CR, HB                  | 14  | R    | 11    | 3    | 763301       | <b>012047</b> |   |      |       |               |                      |      |       |               |
| CR, HB                  | 14  | R    | 13    | 3    | 763302       | <b>011001</b> |   |      |       |               |                      |      |       |               |
| 20'-24' - AL, SK        | 13-3/4  | R    | 15    | 3    | 763466       | <b>011002</b> | 13-5/8  | R    | 15    | <b>335030</b> |                      |      |       |               |
| 19'-22' - AL, SK        | 13-1/4  | R    | 17    | 3    | 763463       | <b>011003</b> | 13-1/2  | R    | 17    | <b>335031</b> |                      |      |       |               |
| 19'-22' - AL, SK        | 14  | R    | 17    | 3    | 763463       | <b>011024</b> |   |      |       |               |                      |      |       |               |
| 17'-19' - AL, SK        | 13  | R    | 19    | 3    | 763464       | <b>011004</b> | 13-3/8  | R    | 19    | <b>335032</b> |                      |      |       |               |
| 17'-19' - AL, SK        | 14  | R    | 19    | 3    | 763464       | <b>011025</b> |   |      |       |               |                      |      |       |               |
| 15'-18' - AL, SK        | 12-3/4  | R    | 21    | 3    | 763465       | <b>011005</b> | 13-1/8  | R    | 21    | <b>335033</b> |                      |      |       |               |
| High Performance        |   |      |       |      |              |               |   |      |       |               | 13-1/2               | R    | 22    | <b>335034</b> |
| High Performance        |   |      |       |      |              |               |   |      |       |               | 13-1/2               | R    | 24    | <b>335035</b> |

Drop-In Hub

Use XHS II® Hub Kit

**206**

Do NOT use Gearcase Adapter Ring supplied with propeller.

Refer to Pages 40-41 for Details on Hub Kit Components.

Rubber Hub Bushing

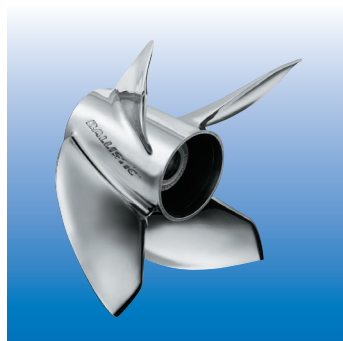



Key to Abbreviations: LL = Light Loads; SB = Sailboat; AL = All Loads; SK = Skiboat; WB = Workboat; HB = Houseboat; CR = Cruisers; HL = Heavy Loads; WD = Weedless

EVINRUDE / JOHNSON

**90, 115 & 140 HORSEPOWER (4-STROKE) • 4-1/4" GEARCASE**

Thru Hub Exhaust & 15 Tooth Spline

90 HP 4-Stroke .....2003 & Newer      115 HP 4-Stroke .....2003 & Newer      140 HP 4-Stroke .....2003 & Newer

| Boat Description/Length | <br>ALUMINUM PROPELLERS |      |       |      |              |          | <br>STAINLESS STEEL PROPELLERS |      |       |      |              |          |
|-------------------------|--|------|-------|------|--------------|----------|---|------|-------|------|--------------|----------|
|                         | Dia.   | Rot. | Pitch | Bld# | OEM Part No. | Part No. | Dia.  | Rot. | Pitch | Bld# | OEM Part No. | Part No. |
|                         |  | 14   | R     | 10   | 3            |          | 992109  |      |       |      |              |          |
|                         | 14   | R    | 13    | 3    | 765181       | 992112   |   |      |       |      |              |          |
| 20'-24' - AL, SK        | 13-3/4   | R    | 15    | 3    | 765182       | 992113   | 13-3/8  | R    | 15    | 3    | 763950       | 993143   |
| 20'-24' - AL, SK        |  |      |       |      |              |          | 13-3/8  | L    | 15    | 3    |              | 993153   |
| 17'-19' - AL, SK        | 13-1/4   | R    | 17    | 3    | 765183       | 992114   | 13-1/4  | R    | 17    | 3    | 763951       | 993144   |
| 17'-19' - AL, SK        |  |      |       |      |              |          | 13-1/4  | L    | 17    | 3    |              | 993154   |
| 16'-18' - AL, SK        | 13   | R    | 19    | 3    | 765184       | 992115   | 13-1/8  | R    | 19    | 3    | 763952       | 993145   |
| 16'-18' - AL, SK        |  |      |       |      |              |          | 13-1/8  | L    | 19    | 3    |              | 993155   |
| 15'-18' - AL, SK        | 12-3/4   | R    | 21    | 3    | 765185       | 992116   | 13  | R    | 21    | 3    |              | 993146   |
| 15'-18' - AL, SK        |  |      |       |      |              |          | 13  | L    | 21    | 3    |              | 993156   |

Drop-In Hub  
Use XHS II® Hub Kit  
**225 / 226**  
USE Gearcase Adapter Ring supplied with propeller.  
Refer to Pages 40-41 for Details on Hub Kit Components.

Note: For 90 & 115 HP 4-Stroke engine applications use XHS II® (Drop-In Hub) Kit #225.  
For 140 HP 4-Stroke engine applications use XHS II® (Drop-In Hub) Kit # 226.

| Boat Description/Length | <br>ALUMINUM PROPELLERS |      |       |      |              |          |
|-------------------------|--|------|-------|------|--------------|----------|
|                         | Dia.   | Rot. | Pitch | Bld# | OEM Part No. | Part No. |
|                         | 20'-24' - AL, SK   | 14   | R     | 15   | 3            | 778738   |
| 17'-19' - AL, SK        | 14   | R    | 17    | 3    | 778739       | 061024   |
| 16'-18' - AL, SK        | 14   | R    | 19    | 3    | 778740       | 061028   |
| 15'-18' - AL, SK        | 14   | R    | 21    | 3    | 778741       | 061032   |





Michigan Match® Aluminum Propeller

Rubber Hub Bushing

**200 & 225 HORSEPOWER (4-STROKE) • 4-3/4" GEARCASE**

Thru Hub Exhaust & 15 Tooth Spline • Vortex® and Apollo® propeller diameters are slightly less than original equipment propellers.

200 HP 4-Stroke .....2004-2005      225 HP 4-Stroke .....2004-2005

| <br>3-BLADE |      |       |          | <br>4-BLADE |      |       |          | STD. 3-BLADE |      |       |          | LG DIAMETER 3-BLADE |      |       |          | 4-BLADE |      |       |          |
|--|------|-------|----------|---|------|-------|----------|--------------|------|-------|----------|---------------------|------|-------|----------|---------|------|-------|----------|
| Dia.   | Rot. | Pitch | Part No. | Dia.  | Rot. | Pitch | Part No. | Dia.         | Rot. | Pitch | Part No. | Dia.                | Rot. | Pitch | Part No. | Dia.    | Rot. | Pitch | Part No. |
| 15-1/4   | R    | 15    | 992002   |   |      |       |          | 14-3/8       | R    | 15    | 993042   |                     |      |       |          |         |      |       |          |
|  |      |       |          |   |      |       |          | 14-3/8       | L    | 15    | 993052   |                     |      |       |          |         |      |       |          |
| 15   | R    | 17    | 992003   | 15  | R    | 16    | 992202   | 14-1/4       | R    | 17    | 993043   | 15-1/2              | R    | 17    | 993023   | 14-5/8  | R    | 16    | 993203   |
|  |      |       |          |   |      |       |          | 14-1/4       | L    | 17    | 993053   | 15-1/2              | L    | 17    | 993033   | 14-5/8  | L    | 16    | 993213   |
| 14-1/2   | R    | 19    | 992004   | 14-1/2  | R    | 18    | 992203   | 14-1/8       | R    | 19    | 993044   | 15-1/4              | R    | 19    | 993024   | 14-3/8  | R    | 18    | 993204   |
|  |      |       |          |   |      |       |          | 14-1/8       | L    | 19    | 993054   | 15-1/4              | L    | 19    | 993034   | 14-3/8  | L    | 18    | 993214   |
| 14-1/4   | R    | 21    | 992005   | 14  | R    | 20    | 992204   | 14           | R    | 21    | 993045   | 14-3/4              | R    | 21    | 993025   | 14-1/8  | R    | 20    | 993205   |
|  |      |       |          |   |      |       |          | 14           | L    | 21    | 993055   | 14-3/4              | L    | 21    | 993035   | 14-1/8  | L    | 20    | 993215   |
| 14   | R    | 23    | 992006   |   |      |       |          | 13-7/8       | R    | 23    | 993046   | 14-5/8              | R    | 23    | 993026   | 14      | R    | 22    | 993206   |
|  |      |       |          |   |      |       |          | 13-7/8       | L    | 23    | 993056   | 14-5/8              | L    | 23    | 993036   | 14      | L    | 22    | 993216   |

Drop-In Hub  
Use XHS II® Hub Kit  
**204**  
Refer to Pages 40-41 for Details on Hub Kit Components.

Key to Abbreviations: LL = Light Loads; SB = Sailboat; AL = All Loads; SK = Skiboat; WB = Workboat; HB = Houseboat; CR = Cruisers; HL = Heavy Loads; WD = Weedless

**90-300 HORSEPOWER • V-6 (4-3/4") GEARCASE (Includes E-Tec® Engines)**

Thru Hub Exhaust & 15 Tooth Spline

|                        |              |
|------------------------|--------------|
| 90 HP.....             | 1995 & Newer |
| 100 HP Commercial..... | 1984 & Newer |
| 115 HP.....            | 1995 & Newer |
| 120-140 HP.....        | 1985         |
| 130 HP.....            | 1995 & Newer |
| 140 (25") HP.....      | 1989-1994    |
| 150 HP Commercial..... | 1995 & Newer |
| 150 HP.....            | 1978 & Newer |

|                        |              |
|------------------------|--------------|
| 155 HP Commercial..... | 1978 & Newer |
| 175 HP.....            | 1977 & Newer |
| 185 HP.....            | 1984-1985    |
| 200 HP.....            | 1976 & Newer |
| 225 HP.....            | 1986 & Newer |
| 235 HP.....            | 1978-1985    |
| 250 HP.....            | 1991 & Newer |
| 275 HP.....            | 1986-1988    |

|                    |              |
|--------------------|--------------|
| 300 HP.....        | 1988-1995    |
| 300 HP E-Tec®..... | 2009 & Newer |
| 2.6 Liter.....     | 1984-1985    |
| 3.6 Liter.....     | 1986-1987    |

\*For engines 300 HP or higher, use "high horsepower sleeve". See Page 40 for more details.

| 3-BLADE |      |       |          | 4-BLADE |      |       |          | STD. 3-BLADE |      |       |          | LG DIAMETER 3-BLADE |      |       |          | 4-BLADE |      |       |          |
|---------|------|-------|----------|---------|------|-------|----------|--------------|------|-------|----------|---------------------|------|-------|----------|---------|------|-------|----------|
| Dia.    | Rot. | Pitch | Part No. | Dia.    | Rot. | Pitch | Part No. | Dia.         | Rot. | Pitch | Part No. | Dia.                | Rot. | Pitch | Part No. | Dia.    | Rot. | Pitch | Part No. |
| 15-1/4  | R    | 15    | 992002   |         |      |       |          | 14-3/8       | R    | 15    | 993042   |                     |      |       |          |         |      |       |          |
|         |      |       |          |         |      |       |          | 14-3/8       | L    | 15    | 993052   |                     |      |       |          |         |      |       |          |
| 15      | R    | 17    | 992003   | 15      | R    | 16    | 992202   | 14-1/4       | R    | 17    | 993043   | 15-1/2              | R    | 17    | 993023   | 14-5/8  | R    | 16    | 993203   |
|         |      |       |          |         |      |       |          | 14-1/4       | L    | 17    | 993053   | 15-1/2              | L    | 17    | 993033   | 14-5/8  | L    | 16    | 993213   |
| 14-1/2  | R    | 19    | 992004   | 14-1/2  | R    | 18    | 992203   | 14-1/8       | R    | 19    | 993044   | 15-1/4              | R    | 19    | 993024   | 14-3/8  | R    | 18    | 993204   |
|         |      |       |          |         |      |       |          | 14-1/8       | L    | 19    | 993054   | 15-1/4              | L    | 19    | 993034   | 14-3/8  | L    | 18    | 993214   |
| 14-1/4  | R    | 21    | 992005   | 14      | R    | 20    | 992204   | 14           | R    | 21    | 993045   | 14-3/4              | R    | 21    | 993025   | 14-1/8  | R    | 20    | 993205   |
|         |      |       |          |         |      |       |          | 14           | L    | 21    | 993055   | 14-3/4              | L    | 21    | 993035   | 14-1/8  | L    | 20    | 993215   |
| 14      | R    | 23    | 992006   |         |      |       |          | 13-7/8       | R    | 23    | 993046   | 14-5/8              | R    | 23    | 993026   | 14      | R    | 22    | 993206   |
|         |      |       |          |         |      |       |          | 13-7/8       | L    | 23    | 993056   | 14-5/8              | L    | 23    | 993036   | 14      | L    | 22    | 993216   |

**Drop-In Hub**  
Use XHS II® Hub Kit  
**200 / 201**  
Refer to Pages 40-41 for Details on Hub Kit Components.

Note: For engine applications 1976-1990 use XHS II® (Drop-In Hub) Kit #201.  
For engine applications 1991 & Newer use XHS II® (Drop-In Hub) Kit #200.

| Boat Description/Length |                     |      |       |      |              |          |                            |       |          |                      |                      |       |          |        |
|-------------------------|---------------------|------|-------|------|--------------|----------|----------------------------|-------|----------|----------------------|----------------------|-------|----------|--------|
|                         | ALUMINUM PROPELLERS |      |       |      |              |          | STAINLESS STEEL PROPELLERS |       |          |                      |                      |       |          |        |
|                         | Dia.                | Rot. | Pitch | Bld# | OEM Part No. | Part No. | 3-BLADE BALLISTIC          |       |          |                      | 3-BLADE BALLISTIC XL |       |          |        |
|                         |                     |      |       |      |              | Dia.     | Rot.                       | Pitch | Part No. | Dia.                 | Rot.                 | Pitch | Part No. |        |
| CR, HB                  | 15-1/2              | R    | 13    | 3    | 763453       | 011016   |                            |       |          |                      |                      |       |          |        |
| CR, HB                  | 15-1/2              | R    | 15    | 3    | 763471       | 011006   | 14-7/8                     | R     | 15       | 345031               |                      |       |          |        |
| 20'-26' - AL, SK        | 15                  | R    | 17    | 3    | 763467       | 011007   | 14-3/4                     | R     | 17       | 345032               |                      |       |          |        |
| 20'-26' - AL, SK        |                     |      |       |      |              |          | 14-3/4                     | L     | 17       | 345062               |                      |       |          |        |
| 18'-22' - AL, SK        | 14-1/2              | R    | 19    | 3    | 763468       | 011008   | 14-1/2                     | R     | 19       | 345033               |                      |       |          |        |
| 18'-22' - AL, SK        |                     |      |       |      |              |          | 14-1/2                     | L     | 19       | 345063               |                      |       |          |        |
| 17'-19' - AL, SK        | 14-1/4              | R    | 21    | 3    | 763469       | 011009   | 14-3/8                     | R     | 21       | 345034               |                      |       |          |        |
| 17'-19' - AL, SK        |                     |      |       |      |              |          | 14-3/8                     | L     | 21       | 345064               |                      |       |          |        |
| 15'-18' - AL, SK        | 14-1/4              | R    | 23    | 3    | 763470       | 011010   | 14-1/4                     | R     | 23       | 345035               |                      |       |          |        |
| 15'-18' - AL, SK        |                     |      |       |      |              |          | 14-1/4                     | L     | 23       | 345065               |                      |       |          |        |
| High Performance        |                     |      |       |      |              |          |                            |       |          | 14-1/2               | R                    | 22    | 345041   |        |
| High Performance        |                     |      |       |      |              |          | 14-1/4                     | R     | 25       | 345036               | 14-1/2               | R     | 24       | 345037 |
| High Performance        |                     |      |       |      |              |          |                            |       |          | 14-1/2               | R                    | 26    | 345038   |        |
|                         |                     |      |       |      |              |          |                            |       |          | 4-BLADE BALLISTIC XL |                      |       |          |        |
| 50-62 MPH               |                     |      |       |      |              |          |                            |       |          | 13-3/4               | R                    | 23    | 435035   |        |
| 55-67 MPH               |                     |      |       |      |              |          |                            |       |          | 13-3/4               | R                    | 25    | 435036   |        |
| 60-72 MPH               |                     |      |       |      |              |          |                            |       |          | 13-3/4               | R                    | 27    | 435037   |        |

**Rubber Hub Bushing**

Key to Abbreviations: LL = Light Loads; SB = Sailboat; AL = All Loads; SK = Skiboat; WB = Workboat; HB = Houseboat; CR = Cruisers; HL = Heavy Loads; WD = Weedless

⚠ Limited Inventory Item.  
⌚ Use OEM thrust washer 127084 for 1990 and earlier motors, or 126869 for 1991 and newer motors.

**3.5-8 HORSEPOWER**

Non-Thru Hub Exhaust & 9 Tooth / Pin Drive

|                      |                      |                      |
|----------------------|----------------------|----------------------|
| 3.5 HP.....1982-1984 | 5 HP.....1987-1998   | 7 HP.....1968-1988   |
| 4 HP.....1977-1987   | 6 HP.....1975-1981   | 7.5 HP.....1979-1984 |
| 4.4 HP.....1968-1988 | 6.6 HP.....1968-1988 | 8 HP.....1975-1978   |

| <b>ALUMINUM PROPELLERS</b> |       |      |       |      |              |               |
|----------------------------|-------|------|-------|------|--------------|---------------|
| Boat Description/Length    | Dia.  | Rot. | Pitch | Bld# | OEM Part No. | Part No.      |
| Standard Replacement       | 7-1/4 | R    | 5-1/2 | 3    | 48-FP488     | <b>072123</b> |



**Rubber Hub Bushing**

**6-10 HORSEPOWER**

Non-Thru Hub Exhaust & 14 Tooth / Pin Drive

|                                |                          |                     |
|--------------------------------|--------------------------|---------------------|
| 6 & 10 HP Sailor.....1976-1977 | Sailor 180.....1979-1984 | Sailor 280.....1979 |
| Sailor 150.....1978            | Sailor 250.....1979-1984 |                     |

| <b>ALUMINUM PROPELLERS</b> |        |      |       |      |              |               |
|----------------------------|--------|------|-------|------|--------------|---------------|
| Boat Description/Length    | Dia.   | Rot. | Pitch | Bld# | OEM Part No. | Part No.      |
| SB                         | 10-3/8 | R    | 10    | 3    | FP-278       | <b>072014</b> |



**Rubber Hub Bushing**

**25 HORSEPOWER • 3" GEARCASE**

Thru Hub Exhaust & 10 Tooth Spline

25 HP 3 Cyl.....1995-1998

| <b>ALUMINUM PROPELLERS</b> |        |      |       |      |              |               |
|----------------------------|--------|------|-------|------|--------------|---------------|
| Boat Description/Length    | Dia.   | Rot. | Pitch | Bld# | OEM Part No. | Part No.      |
|                            | 10-1/2 | R    | 9     | 3    |              | <b>992501</b> |
|                            | 10-1/2 | R    | 10    | 3    |              | <b>992502</b> |
| 15'-19' - AL               | 10-1/2 | R    | 11    | 3    | 48-19638A40  | <b>992503</b> |
| 15'-17' - AL               | 10-1/8 | R    | 12    | 3    |              | <b>992504</b> |
| 13'-17' - LL               | 10-1/8 | R    | 13    | 3    | 48-19640A40  | <b>992505</b> |
| Up to 14' - LL             | 10-1/8 | R    | 14    | 3    |              | <b>992506</b> |

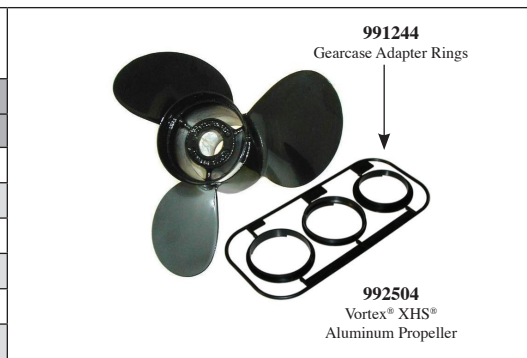

**Drop-In Hub**  
Use XHS® Hub Kit **120**  
MUST use Gearcase Adapter Ring supplied with propeller.  
Refer to Pages 40-41 for Details on Hub Kit Components.

| <b>ALUMINUM PROPELLERS</b> |        |      |       |      |              |               |
|----------------------------|--------|------|-------|------|--------------|---------------|
| Boat Description/Length    | Dia.   | Rot. | Pitch | Bld# | OEM Part No. | Part No.      |
| 15'-19'                    | 10-3/8 | R    | 11    | 3    | 48-19638A40  | <b>031049</b> |
| 13'-17'                    | 10-3/8 | R    | 13    | 3    | 48-19640A40  | <b>031048</b> |
| Up to 14'                  |        |      |       |      |              |               |

| <b>STAINLESS STEEL PROPELLERS</b> |        |       |      |              |          |               |
|-----------------------------------|--------|-------|------|--------------|----------|---------------|
| Dia.                              | Rot.   | Pitch | Bld# | OEM Part No. | Part No. |               |
|                                   | 10-1/8 | R     | 13   | 3            |          | <b>305129</b> |
|                                   | 10-1/8 | R     | 15   | 3            |          | <b>305130</b> |

**Rubber Hub Bushing**



**20-60 HORSEPOWER**

Non-Thru Hub Exhaust & 14 Tooth / Pin Drive

|                        |                     |                        |
|------------------------|---------------------|------------------------|
| 20-25 HP.....1979-1981 | 40 HP.....1992-1994 | 55 HP ❖❖.....1966-1983 |
| 30 HP.....1966-1976    | 45 HP.....1966-1984 | 60 HP ❖❖.....1966-1975 |
| 35 HP.....1966-1991    | 50 HP.....1982-1994 |                        |

| Boat Description/Length | MICHIGAN MATCH<br>REPLACEMENT PROPELLERS |      |        |      |              |          |
|-------------------------|--|------|--------|------|--------------|----------|
|                         | ALUMINUM PROPELLERS                      |      |        |      |              |          |
|                         | Dia.                                     | Rot. | Pitch  | Bld# | OEM Part No. | Part No. |
| CR, HB, SB              | 10-3/8                                   | R    | 10     | 3    | 48-819337A40 | 072014   |
| 17'-19' - AL, SK        | 10-3/8                                   | R    | 11-1/2 | 3    | 48-819336A40 | 072131   |
| 16'-17' - AL, SK        | 10-3/8                                   | R    | 12-1/2 | 3    | 48-819335A40 | 072132   |
| 14'-16' - AL, SK        | 10-3/8                                   | R    | 13-1/2 | 3    | 48-819334A40 | 072133   |



Rubber Hub Bushing

**40-75 HORSEPOWER • 3-1/4" GEARCASE**

Thru Hub Exhaust & 13 Tooth Spline

|                     |                     |                     |
|---------------------|---------------------|---------------------|
| 40 HP.....1995-1998 | 70 HP.....1991-1995 | 75 HP.....1996-1998 |
| 50 HP.....1995-1998 |                     |                     |

| VORTEX <sup>XHS</sup> |      |       |          |                      |      |       |          |        |      |       |          |
|-----------------------|------|-------|----------|----------------------|------|-------|----------|--------|------|-------|----------|
| ALUMINUM PROPELLERS   |      |       |          |                      |      |       |          |        |      |       |          |
| 3-BLADE               |      |       |          | 3-BLADE LG. DIAMETER |      |       | 4-BLADE  |        |      |       |          |
| Dia.                  | Rot. | Pitch | Part No. | Dia.                 | Rot. | Pitch | Part No. | Dia.   | Rot. | Pitch | Part No. |
|                       |      |       |          |                      |      |       |          | 11-1/2 | R    | 8     | 992401   |
|                       |      |       |          | 12-1/4               | R    | 9     | 992601   | 11-1/2 | R    | 9     | 992402   |
|                       |      |       |          | 11-3/4               | R    | 10    | 992602   | 11-1/2 | R    | 10    | 992403   |
| 10-3/8                | R    | 11    | 992404   | 11-5/8               | R    | 11    | 992603   |        |      |       |          |
| 10-3/8                | R    | 12    | 992405   | 11-3/8               | R    | 12    | 992604   |        |      |       |          |
| 10-3/8                | R    | 13    | 992406   | 11-1/8               | R    | 13    | 992605   |        |      |       |          |
| 10-3/8                | R    | 14    | 992407   | 11-1/4               | R    | 14    | 992606   |        |      |       |          |
| 10                    | R    | 15    | 992408   |                      |      |       |          |        |      |       |          |
| 10                    | R    | 16    | 992409   |                      |      |       |          |        |      |       |          |

| APOLLO                     |      |       |      |              |          |  |
|----------------------------|------|-------|------|--------------|----------|--|
| STAINLESS STEEL PROPELLERS |      |       |      |              |          |  |
| Dia.                       | Rot. | Pitch | Bld# | OEM Part No. | Part No. |  |
| 10-3/4                     | R    | 12    | 3    |              | 993405   |  |
| 10-1/2                     | R    | 13    | 3    |              | 993406   |  |
| 10-3/8                     | R    | 14    | 3    |              | 993407   |  |
| 10-1/8                     | R    | 15    | 3    |              | 993408   |  |

Drop-In Hub  
Use XHS® Hub Kit  
**114**  
Refer to Pages 40-41 for Details on Hub Kit Components.

| Boat Description/Length | MICHIGAN MATCH<br>REPLACEMENT PROPELLERS |      |        |      |              |          |
|-------------------------|--|------|--------|------|--------------|----------|
|                         | ALUMINUM PROPELLERS                      |      |        |      |              |          |
|                         | Dia.                                     | Rot. | Pitch  | Bld# | OEM Part No. | Part No. |
| 19' & Up                | 12-1/2                                   | R    | 8      | 3    | 48-42738A10  | 032141   |
| 19' & Up                | 12-1/4                                   | R    | 9      | 3    |              | 032143   |
| 17'-19' - AL, SK        | 11-1/4                                   | R    | 10     | 3    | 48-73132A40  | 031015   |
| 16'-18' - AL, SK        | 12                                       | R    | 10-1/2 | 3    | 48-42740A10  | 032142   |
| 16'-18' - AL, SK        | 10-7/8                                   | R    | 11     | 3    | 48-85632A40  | 031053   |
| 15'-17' - AL, SK        | 10-3/4                                   | R    | 12     | 3    | 48-816702A40 | 031056   |
| 15'-17' - AL, SK        | 10-5/8                                   | R    | 12     | 3    | 48-73134A40  | 031016   |
| 14'-17' - AL, SK        | 10-1/2                                   | R    | 13     | 3    | 48-816704A40 | 031057   |
| 14'-17' - AL, SK        | 10-3/8                                   | R    | 13     | 3    | 48-73136A40  | 031017   |
| 14'-16' - LL            | 10-3/8                                   | R    | 14     | 3    | 48-816706A40 | 031058   |
| 14'-16' - LL            | 10-1/4                                   | R    | 14     | 3    | 48-73138A40  | 031018   |
| 13'-15' - LL            | 10-1/8                                   | R    | 15     | 3    | 48-73140A40  | 031019   |
| Up to 15'               | 10                                       | R    | 17     | 3    | 48-73144A40  | 031020   |

| BALLISTIC <sup>®</sup><br>STAINLESS STEEL PROPS |      |       |      |              |          |  |
|---|------|-------|------|--------------|----------|--|
| STAINLESS STEEL PROPELLERS                      |      |       |      |              |          |  |
| Dia.  | Rot. | Pitch | Bld# | OEM Part No. | Part No. |  |
| 10-1/8  | R    | 13    | 3    |              | 395129   |  |
| 10-1/8  | R    | 15    | 3    |              | 395130   |  |

Rubber Hub Bushing

Key to Abbreviations: LL = Light Loads; SB = Sailboat; AL = All Loads; SK = Skiboat; WB = Workboat; HB = Houseboat; CR = Cruisers; HL = Heavy Loads; WD = Weedless

❖❖ Two-piece lower unit.

FORCE / CHRYSLER / U.S. MARINE

**75-140 HORSEPOWER • SINGLE EXHAUST UNITS (SEE BELOW)**

Non-Thru Hub Exhaust & 15 Tooth Spline

|                                     |                                       |                        |
|-------------------------------------|---------------------------------------|------------------------|
| 75 HP Std. & Charger .....1980-1984 | 105 HP .....1977-1978; 1982           | 135 HP .....1977       |
| 85 HP Std. & Charger .....1978-1989 | 115 HP Std. & Charger ..... 1978-1984 | 140 HP ..... 1978-1984 |
| 90 HP .....1983-1984                | 120 HP .....1977                      |                        |
| 100 HP .....1979-1984               | 125 HP ..... 1977; 1982; 1985-1989    |                        |



**ALUMINUM PROPELLERS**

| Boat Description/Length | Dia.   | Rot. | Pitch | Bld# | OEM Part No. | Part No. |
|-------------------------|--------|------|-------|------|--------------|----------|
| 16'-17' - AL, SK        | 13-1/8 | R    | 15    | 3    | FPS519       | 072055   |
| 14'-16' - AL, SK        | 13-1/4 | R    | 17    | 3    | FPS623       | 072107   |
| 14'-16' - LL            | 13     | R    | 19    | 3    | FPS625       | 072108   |

072108



Rubber Hub Bushing

**85-150 HORSEPOWER • DUAL EXHAUST UNITS • 4-1/4" GEARCASE (SEE BELOW)**

Thru Hub Exhaust & 15 Tooth Spline

|                              |                                |                          |
|------------------------------|--------------------------------|--------------------------|
| 85 HP .....1988-1989         | 120 HP .....1990-1994          | 150 HP ..... 1989-1994   |
| 90 HP .....1990-1994         | 120 HP L-Drive ..... 1989-1991 | 150 HP L-Drive .....1991 |
| 90 HP L-Drive .....1989-1991 | 125 HP ..... 1988-1989         |                          |



**ALUMINUM PROPELLERS**

| Boat Description/Length | Dia.   | Rot. | Pitch | Bld# | OEM Part No. | Part No. |
|-------------------------|--------|------|-------|------|--------------|----------|
| 22' & Up                | 14     | R    | 10    | 3    |              | 992109   |
| 22' & Up                | 14     | R    | 13    | 3    |              | 992112   |
| 19'-24' - AL, SK        | 13-3/4 | R    | 15    | 3    |              | 992113   |
| 17'-21' - AL, AK        | 13-1/4 | R    | 17    | 3    |              | 992114   |
| 16'-19' - AL, SK        | 13     | R    | 19    | 3    |              | 992115   |
| 15'-18' - AL, SK        | 12-3/4 | R    | 21    | 3    |              | 992116   |



Vortex® XHS® Aluminum Propeller

Drop-In Hub

Use XHS II® Hub Kit

202

Do NOT use Gearcase Adapter Ring supplied with propeller.

Refer to Pages 40-41 for Details on Hub Kit Components.



**ALUMINUM PROPELLERS**

| Boat Description/Length | Dia.   | Rot. | Pitch | Bld# | OEM Part No. | Part No. |
|-------------------------|--------|------|-------|------|--------------|----------|
| 17'-22' - AL, SK        | 13-1/2 | R    | 15    | 3    | 48-FP669-1   | * 071035 |
| 17'-22' - AL, SK        | 13-1/2 | R    | 15    | 3    | 48-FP692-1   | 072127   |
| 16'-20' - AL, SK        | 13-1/2 | R    | 17    | 3    | 48-FP685-1   | * 071036 |
| 16'-20' - AL, SK        | 13-1/2 | R    | 17    | 3    | 48-FP685-1   | 072128   |



071036

Rubber Hub Bushing

**Single vs. Dual Exhaust**

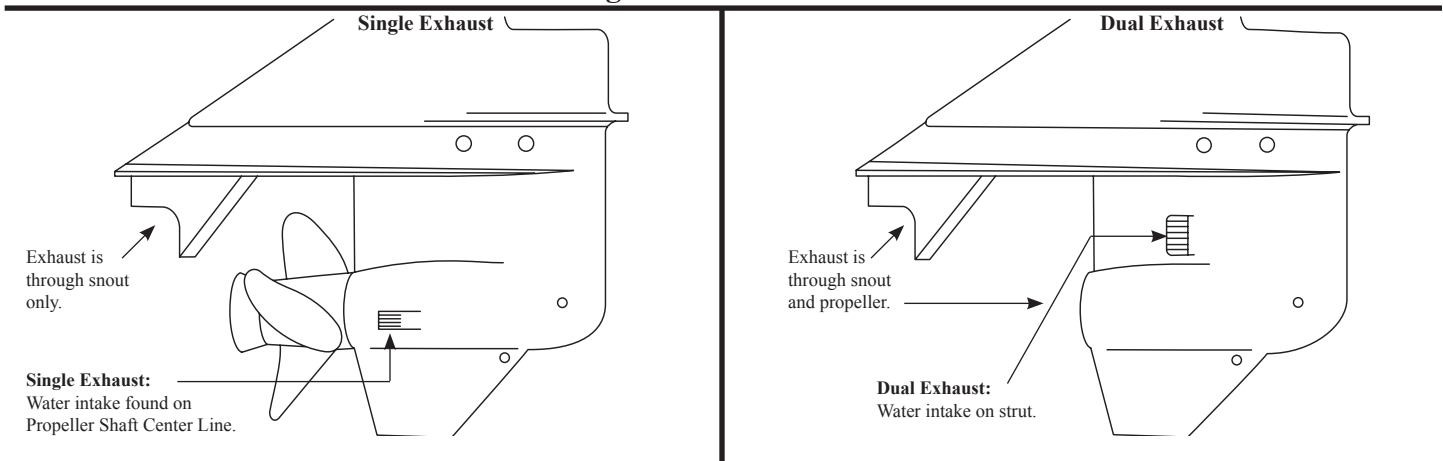



Key to Abbreviations: LL = Light Loads; SB = Sailboat; AL = All Loads; SK = Skiboat; WB = Workboat; HB = Houseboat; CR = Cruisers; HL = Heavy Loads; WD = Weedless

❖ One Piece Lower Unit  
\* If currently using uncupped propeller, use cupped propeller having 2" less pitch. Boats with power trim use same pitch.



**75-150 HORSEPOWER • USING MERCURY 4-1/4" GEARCASE (SEE BELOW)**

Thru Hub Exhaust & 15 Tooth Spline

|                               |                                |                         |
|-------------------------------|--------------------------------|-------------------------|
| 75 HP ●.....1999 & Newer      | 120 HP ●.....1995-1996         | 150 HP ~.....1989-1994  |
| 90 HP ●.....1995-1996         | 120 HP L-Drive ~.....1990-1991 | 150 HP L-Drive.....1991 |
| 90 HP L-Drive ~.....1990-1991 |                                |                         |

| Boat Description/Length |  |      |       |      |              |          |  |      |       |      |              |          |
|-------------------------|---|------|-------|------|--------------|----------|---|------|-------|------|--------------|----------|
|                         | ALUMINUM PROPELLERS   |      |       |      |              |          | STAINLESS STEEL PROPELLERS  |      |       |      |              |          |
|                         | Dia.  | Rot. | Pitch | Bld# | OEM Part No. | Part No. | Dia.  | Rot. | Pitch | Bld# | OEM Part No. | Part No. |
| 22' & Up                | 14  | R    | 10    | 3    |              | 992109   |   |      |       |      |              |          |
| 22' & Up                | 14  | R    | 13    | 3    |              | 992112   |   |      |       |      |              |          |
| 19'-24' - AL, SK        | 13-3/4  | R    | 15    | 3    |              | 992113   | 13-3/8  | R    | 15    | 3    |              | 993143   |
| 19'-24' - AL, SK        |   |      |       |      |              |          | 13-3/8  | L    | 15    | 3    |              | 993153   |
| 17'-21' - AL, SK        | 13-1/4  | R    | 17    | 3    |              | 992114   | 13-1/4  | R    | 17    | 3    |              | 993144   |
| 17'-21' - AL, SK        |   |      |       |      |              |          | 13-1/4  | L    | 17    | 3    |              | 993154   |
| 16'-19' - AL, SK        | 13  | R    | 19    | 3    |              | 992115   | 13-1/8  | R    | 19    | 3    |              | 993145   |
| 16'-19' - AL, SK        |   |      |       |      |              |          | 13-1/8  | L    | 19    | 3    |              | 993155   |
| 15'-18' - AL, SK        | 12-3/4  | R    | 21    | 3    |              | 992116   | 13  | R    | 21    | 3    |              | 993146   |
| 15'-18' - AL, SK        |   |      |       |      |              |          | 13  | L    | 21    | 3    |              | 993156   |

| Boat Description/Length |  |      |       |      |              |          |  |      |       |          |                      |      |       |          |
|-------------------------|---|------|-------|------|--------------|----------|---|------|-------|----------|----------------------|------|-------|----------|
|                         | ALUMINUM PROPELLERS   |      |       |      |              |          | 3-BLADE BALLISTIC   |      |       |          | 3-BLADE BALLISTIC XL |      |       |          |
|                         | Dia.  | Rot. | Pitch | Bld# | OEM Part No. | Part No. | Dia.  | Rot. | Pitch | Part No. | Dia.                 | Rot. | Pitch | Part No. |
| 25' & Up - AL           | 14  | R    | 10    | 3    |              | 031061   |   |      |       |          |                      |      |       |          |
| 25' & Up - AL           | 14  | R    | 11    | 3    | 48-77338A45  | 031054   |   |      |       |          |                      |      |       |          |
| Pontoon                 | 14  | R    | 11    | 3    | 48-77338CP1  | ☉ 031200 |   |      |       |          |                      |      |       |          |
| 25' & Up - AL           | 14  | R    | 12    | 3    |              | 031060   |   |      |       |          |                      |      |       |          |
| Pontoon                 | 14  | R    | 12    | 3    |              | ☉ 031201 |   |      |       |          |                      |      |       |          |
| 22' & Up                | 14  | R    | 13    | 3    | 48-77340A45  | 031055   |   |      |       |          |                      |      |       |          |
| Pontoon                 | 14  | R    | 13    | 3    | 48-77340CP1  | ☉ 031202 |   |      |       |          |                      |      |       |          |
| 19'-24' - AL, SK        | 13-3/4  | R    | 15    | 3    | 48-77342A45  | 031041   | 13-5/8  | R    | 15    | 335130   |                      |      |       |          |
| 17'-20' - AL, SK        | 13-1/4  | R    | 17    | 3    | 48-77344A45  | 031042   | 13-1/2  | R    | 17    | 335131   |                      |      |       |          |
| 16'-19' - AL, SK        | 13  | R    | 19    | 3    | 48-77346A45  | 031043   | 13-3/8  | R    | 19    | 335132   |                      |      |       |          |
| 15'-18' - AL, SK        | 12-3/4  | R    | 21    | 3    | 48-77348A45  | 031044   | 13-1/8  | R    | 21    | 335133   | 13-1/2               | R    | 22    | ☉ 335134 |
| Up to 17' - LL          | 12-1/2  | R    | 23    | 3    | 48-77350A45  | ☉ 031045 |   |      |       |          | 13-1/2               | R    | 24    | ☉ 335135 |

Drop-In Hub  
Use XHS II® Hub Kit  
**202**  
USE Grease Adapter Ring supplied with propeller.  
Refer to Pages 40-41 for Details on Hub Kit Components.

Rubber Hub Bushing

FORCE / CHRYSLER / U.S. MARINE

**Force Using Mercury Gearcase**

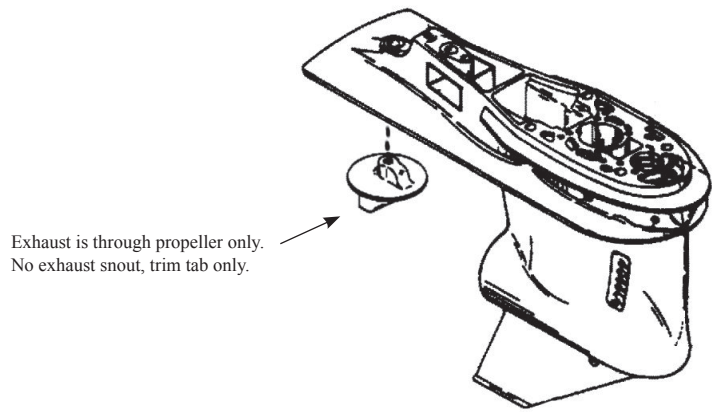

Key to Abbreviations: LL = Light Loads; SB = Sailboat; AL = All Loads; SK = Skiboat; WB = Workboat; HB = Houseboat; CR = Cruisers; HL = Heavy Loads; WD = Weedless

- ☉ Limited Inventory Item.
- ☉ Requires special exhaust snout Part No. F744116 for proper fit.
- For dual exhaust units only. Requires thrust washer 23-819057.
- For all units 1995 & Newer. Requires thrust washer 13191A1.
- ☉ Pontoon Boat Propeller (Extended Cup)

**7.5-10 HORSEPOWER**

Non-Thru Hub Exhaust & Pin Drive

BF 7.5 .....1978-1987                      BF 8 ..... 1987-1999                      BF 100 (10 HP) .....All Years

|                         |       |                            |       |      |                 |               | <br><b>012011</b> | <b>Rubber<br/>Hub<br/>Bushing</b> |
|-------------------------|-------|----------------------------|-------|------|-----------------|---------------|-------------------|-----------------------------------|
|                         |       | <b>ALUMINUM PROPELLERS</b> |       |      |                 |               |                   |                                   |
| Boat Description/Length | Dia.  | Rot.                       | Pitch | Bld# | OEM Part No.    | Part No.      |                   |                                   |
|                         | 9-1/4 | R                          | 7     | 3    |                 | <b>012102</b> |                   |                                   |
| 14'-16' - LL            | 9     | R                          | 9     | 3    | 58130-881-840ZA | <b>012109</b> |                   |                                   |
| 12'-14' - LL            | 9     | R                          | 10    | 3    |                 | <b>012011</b> |                   |                                   |
| 12'-14' - LL            | 9-1/4 | R                          | 11    | 3    |                 | <b>012013</b> |                   |                                   |

**8-20 HORSEPOWER • 2-1/2" GEARCASE**

Thru Hub Exhaust & 8 Tooth Spline

BF 8 TH .....2000 & Newer                      BF 15 .....1991 & Newer                      BF 20 .....2003 & Newer  
BF 9.9 ..... 1988 & Newer

|                         |       |                            |        |      |                 |               | <br><b>102003</b> | <b>Rubber<br/>Hub<br/>Bushing</b> |
|-------------------------|-------|----------------------------|--------|------|-----------------|---------------|-------------------|-----------------------------------|
|                         |       | <b>ALUMINUM PROPELLERS</b> |        |      |                 |               |                   |                                   |
| Boat Description/Length | Dia.  | Rot.                       | Pitch  | Bld# | OEM Part No.    | Part No.      |                   |                                   |
| 13'-17' - AL            | 9-1/4 | R                          | 8      | 3    | 58130-ZV4-008AH | <b>102003</b> |                   |                                   |
| 12'-15' - AL            | 9-1/4 | R                          | 9      | 3    | 58130-ZV4-009AH | <b>102004</b> |                   |                                   |
| 12'-15' - LL            | 9-1/4 | R                          | 10-1/2 | 3    | 58130-ZV4-010AH | <b>102005</b> |                   |                                   |

**25-30 HORSEPOWER • 3" GEARCASE**

Thru Hub Exhaust & 10 Tooth Spline





BF 25 .....1994 & Newer                      BF 30 .....1995 & Newer

|                         |        |                                   |       |      |                 |               | <br><b>991244</b><br>Gearcase Adapter Rings<br><br><b>992504</b><br>Vortex® XHS®<br>Aluminum Propeller | <b>Drop-In Hub</b><br><br>Use XHS®<br>Hub Kit<br><b>119</b><br><br>MUST use Gearcase<br>Adapter Ring supplied<br>with propeller.<br><br>Refer to Pages 40-41<br>for Details on Hub Kit<br>Components. |
|-------------------------|--------|-----------------------------------|-------|------|-----------------|---------------|--|---|
|                         |        | <b>ALUMINUM PROPELLERS</b>        |       |      |                 |               |  |   |
| Boat Description/Length | Dia.   | Rot.                              | Pitch | Bld# | OEM Part No.    | Part No.      |  |   |
|                         | 10-1/2 | R                                 | 9     | 3    |                 | <b>992501</b> |  |   |
|                         | 10-1/2 | R                                 | 10    | 3    |                 | <b>992502</b> |  |   |
|                         | 10-1/2 | R                                 | 11    | 3    |                 | <b>992503</b> |  |   |
|                         | 10-1/8 | R                                 | 12    | 3    | 58130-ZV7-012AH | <b>992504</b> |  |   |
|                         | 10-1/8 | R                                 | 13    | 3    | 58130-ZV7-013AH | <b>992505</b> |  |   |
|                         | 10-1/8 | R                                 | 14    | 3    |                 | <b>992506</b> |  |   |
|                         |        |                                   |       |      |                 |               | <br><b>Ballistic® High Performance<br/>Stainless Steel Propeller</b>                                   | <b>Rubber<br/>Hub<br/>Bushing</b>   |
|                         |        | <b>STAINLESS STEEL PROPELLERS</b> |       |      |                 |               |  |   |
| Boat Description/Length | Dia.   | Rot.                              | Pitch | Bld# | OEM Part No.    | Part No.      |  |   |
|                         | 10-1/8 | R                                 | 13    | 3    |                 | <b>305229</b> |  |   |
|                         | 10-1/8 | R                                 | 15    | 3    |                 | <b>305230</b> |  |   |

**35-60 HORSEPOWER • 3-1/4" GEARCASE**

Thru Hub Exhaust & 13 Tooth Spline

BF 35 .....1991-1994      BF 45 ..... 1991-1994      BF 60 .....2010 & Newer  
 BF 40 ..... 1995 & Newer      BF50/50A ..... 1995 & Newer

|  |        |       |          |                      |                 |       |          |         |      |  |          |              |      |          |      |   |          |  |  |  |  |
|---|--------|-------|----------|----------------------|-----------------|-------|----------|---------|------|---|----------|--------------|------|----------|------|---|----------|--|--|--|--|
| ALUMINUM PROPELLERS   |        |       |          |                      |                 |       |          |         |      | STAINLESS STEEL PROPELLERS  |          |              |      |          |      |   |          |  |  |  |  |
| 3-BLADE   |        |       |          | 3-BLADE LG. DIAMETER |                 |       |          | 4-BLADE |      |   |          |              |      |          |      |   |          |  |  |  |  |
| Dia.  | Rot.   | Pitch | Part No. | Dia.                 | Rot.            | Pitch | Part No. | Dia.    | Rot. | Pitch   | Part No. | Dia.         | Rot. | Pitch    | Bld# | OEM Part No.  | Part No. |  |  |  |  |
|   |        |       |          |                      |                 |       |          | 11-1/2  | R    | 8   | 992401   |              |      |          |      |   |          |  |  |  |  |
|   |        |       |          | 12-1/4               | R               | 9     | 992601   | 11-1/2  | R    | 9   | 992402   |              |      |          |      |   |          |  |  |  |  |
|   |        |       |          | 11-3/4               | R               | 10    | 992602   | 11-1/2  | R    | 10  | 992403   |              |      |          |      |   |          |  |  |  |  |
| 10-3/8  | R      | 11    | 992404   | 11-5/8               | R               | 11    | 992603   |         |      |   |          |              |      |          |      |   |          |  |  |  |  |
| 10-3/8  | R      | 12    | 992405   | 11-3/8               | R               | 12    | 992604   |         |      |   |          | 10-3/4       | R    | 12       | 3    |   | 993405   |  |  |  |  |
| 10-3/8  | R      | 13    | 992406   | 11-1/8               | R               | 13    | 992605   |         |      |   |          | 10-1/2       | R    | 13       | 3    |   | 993406   |  |  |  |  |
| 10-3/8  | R      | 14    | 992407   | 11-1/4               | R               | 14    | 992606   |         |      |   |          | 10-3/8       | R    | 14       | 3    |   | 993407   |  |  |  |  |
| 10  | R      | 15    | 992408   |                      |                 |       |          |         |      |   |          | 10-1/8       | R    | 15       | 3    |   | 993408   |  |  |  |  |
| 10  | R      | 16    | 992409   |                      |                 |       |          |         |      |   |          |              |      |          |      |   |          |  |  |  |  |
|   |        |       |          |                      |                 |       |          |         |      |    |          |              |      |          |      |  |          |  |  |  |  |
| ALUMINUM PROPELLERS   |        |       |          |                      |                 |       |          |         |      | STAINLESS STEEL PROPELLERS  |          |              |      |          |      |   |          |  |  |  |  |
| Boat Description/Length   | Dia.   | Rot.  | Pitch    | Bld#                 | OEM Part No.    |       | Part No. | Dia.    | Rot. | Pitch   | Bld#     | OEM Part No. |      | Part No. |      |   |          |  |  |  |  |
|   | 12-1/4 | R     | 9        | 3                    | 58130-ZV5-009AH |       | 032046   |         |      |   |          |              |      |          |      |   |          |  |  |  |  |
| 19'-21' - AL, SK  | 11-3/4 | R     | 10       | 3                    | 58130-ZV5-860ZA |       | 032045   |         |      |   |          |              |      |          |      |   |          |  |  |  |  |
| 17'-19' - AL, SK  | 11-5/8 | R     | 11       | 3                    | 58130-ZV5-011AH |       | 032044   |         |      |   |          |              |      |          |      |   |          |  |  |  |  |
| 15'-17' - AL, SK  | 11-3/8 | R     | 12       | 3                    | 58130-ZV5-012AH |       | 032043   |         |      |   |          |              |      |          |      |   |          |  |  |  |  |
| 15'-17' - AL, SK  | 11-1/8 | R     | 13       | 3                    | 58130-ZV5-013AH |       | 032042   | 10-1/8  | R    | 13  | 3        |              |      | 395929   |      |   |          |  |  |  |  |
| 14'-16' - AL, SK  | 11-1/4 | R     | 14       | 3                    | 58130-ZV5-014AH |       | 032041   |         |      |   |          |              |      |          |      |   |          |  |  |  |  |
| 13'-15' - AL, SK  | 11     | R     | 15       | 3                    | 58130-ZV5-015AH |       | 032040   | 10-1/8  | R    | 15  | 3        |              |      | 395930   |      |   |          |  |  |  |  |

Drop-In Hub

Use XHS®  
Hub Kit  
**113**

Refer to Pages 40-41  
for Details on Hub Kit  
Components.

Rubber  
Hub  
Bushing

HONDA





Key to Abbreviations: LL = Light Loads; SB = Sailboat; AL = All Loads; SK = Skiboat; WB = Workboat; HB = Houseboat; CR = Cruisers; HL = Heavy Loads; WD = Weedless

**60-130 HORSEPOWER • 4-1/4" GEARCASE**



Thru Hub Exhaust & 15 Tooth Spline

BFP 60 ..... 2010 & Newer      BF 90 ..... 1995 & Newer      BF 130 ..... 1998-2004  
 BF 75 ..... 1995 & Newer      BF 115 ..... 1998 & Newer

| Boat Description/Length |  |      |       |      |                 |               |  |      |       |      |                |               |
|-------------------------|---|------|-------|------|-----------------|---------------|---|------|-------|------|----------------|---------------|
|                         | ALUMINUM PROPELLERS   |      |       |      |                 |               | STAINLESS STEEL PROPELLERS  |      |       |      |                |               |
|                         | Dia.  | Rot. | Pitch | Bld# | OEM Part No.    | Part No.      | Dia.  | Rot. | Pitch | Bld# | OEM Part No.   | Part No.      |
| 25' & Up - AL           | 14  | R    | 10    | 3    |                 | <b>992109</b> |   |      |       |      |                |               |
| 22' & Up - AL           | 14  | R    | 13    | 3    | 58130-ZW1-013AH | <b>992112</b> |   |      |       |      |                |               |
| 19'-24' - AL, SK        | 13-3/4  | R    | 15    | 3    | 58130-ZW1-015AH | <b>992113</b> | 13-3/8  | R    | 15    | 3    | 58133-ZW1-A15P | <b>993143</b> |
| 19'-24' - AL, SK        |   |      |       |      |                 |               | 13-3/8  | L    | 15    | 3    |                | <b>993153</b> |
| 17'-20' - AL, SK        | 13-1/4  | R    | 17    | 3    | 58130-ZW1-017AH | <b>992114</b> | 13-1/4  | R    | 17    | 3    |                | <b>993144</b> |
| 17'-20' - AL, SK        |   |      |       |      |                 |               | 13-1/4  | L    | 17    | 3    |                | <b>993154</b> |
| 16'-19' - AL, SK        | 13  | R    | 19    | 3    | 58130-ZW1-019AH | <b>992115</b> | 13-1/8  | R    | 19    | 3    |                | <b>993145</b> |
| 16'-19' - AL, SK        |   |      |       |      |                 |               | 13-1/8  | L    | 19    | 3    |                | <b>993155</b> |
| 15'-18' - AL, SK        | 12-3/4  | R    | 21    | 3    | 58130-ZW1-021AH | <b>992116</b> | 13  | R    | 21    | 3    |                | <b>993146</b> |
| 15'-18' - AL, SK        |   |      |       |      |                 |               | 13  | L    | 21    | 3    |                | <b>993156</b> |

**Drop-In Hub**  
 Use XHS II® Hub Kit  
**202 / 207**  
 USE Gearcase Adapter Ring supplied with propeller.  
 Refer to Pages 40-41 for Details on Hub Kit Components.

Note: For BF 75 & BF 90 HP 1995-1998 engine applications use XHS II® (Drop-In Hub) Kit #202.  
 For BF 75 & BF 90 HP 1999 & Newer engine applications use XHS II® (Drop-In Hub) Kit #207.  
 For BFP 60, BF 115 & BF 130 HP 1998 & Newer engine applications use XHS II® (Drop-In Hub) Kit #207.

| Boat Description/Length |  |      |       |      |                 |                 |  |      |       |               |                      |      |       |               |
|-------------------------|---|------|-------|------|-----------------|-----------------|---|------|-------|---------------|----------------------|------|-------|---------------|
|                         | ALUMINUM PROPELLERS   |      |       |      |                 |                 | 3-BLADE BALLISTIC   |      |       |               | 3-BLADE BALLISTIC XL |      |       |               |
|                         | Dia.  | Rot. | Pitch | Bld# | OEM Part No.    | Part No.        | Dia.  | Rot. | Pitch | Part No.      | Dia.                 | Rot. | Pitch | Part No.      |
| 25' & Up - AL           | 14  | R    | 10    | 3    |                 | <b>031061</b>   |   |      |       |               |                      |      |       |               |
| 25' & Up - AL           | 14  | R    | 11    | 3    | 58130-ZW1-011AH | <b>031054</b>   |   |      |       |               |                      |      |       |               |
| Pontoon                 | 14  | R    | 11    | 3    |                 | ☉ <b>031200</b> |   |      |       |               |                      |      |       |               |
| 25' & Up - AL           | 14  | R    | 12    | 3    |                 | <b>031060</b>   |   |      |       |               |                      |      |       |               |
| Pontoon                 | 14  | R    | 12    | 3    |                 | ☉ <b>031201</b> |   |      |       |               |                      |      |       |               |
| 22' & Up                | 14  | R    | 13    | 3    | 58130-ZW1-013AH | <b>031055</b>   |   |      |       |               |                      |      |       |               |
| Pontoon                 | 14  | R    | 13    | 3    |                 | ☉ <b>031202</b> |   |      |       |               |                      |      |       |               |
| 19'-24' - AL, SK        | 13-3/4  | R    | 15    | 3    | 58130-ZW1-015AH | <b>031041</b>   | 13-5/8  | R    | 15    | <b>335130</b> |                      |      |       |               |
| 17'-20' - AL, SK        | 13-1/4  | R    | 17    | 3    | 58130-ZW1-017AH | <b>031042</b>   | 13-1/2  | R    | 17    | <b>335131</b> |                      |      |       |               |
| 16'-19' - AL, SK        | 13  | R    | 19    | 3    | 58130-ZW1-019AH | <b>031043</b>   | 13-3/8  | R    | 19    | <b>335132</b> |                      |      |       |               |
| 15'-18' - AL, SK        | 12-3/4  | R    | 21    | 3    | 58130-ZW1-021AH | <b>031044</b>   | 13-1/8  | R    | 21    | <b>335133</b> | 13-1/2               | R    | 22    | <b>335134</b> |
| Up to 17' - LL          | 12-1/2  | R    | 23    | 3    | 58130-ZW1-W512A | ☉ <b>031045</b> |   |      |       |               | 13-1/2               | R    | 24    | <b>335135</b> |

**Rubber Hub Bushing**

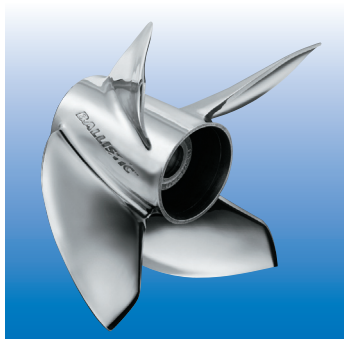

Key to Abbreviations: LL = Light Loads; SB = Sailboat; AL = All Loads; SK = Skiboat; WB = Workboat; HB = Houseboat; CR = Cruisers; HL = Heavy Loads; WD = Weedless

☉ Limited Inventory Item.      ☉ Pontoon Boat Propeller (Extended Cup)



**135-225 HORSEPOWER • 4-3/4" GEARCASE**

Thru Hub Exhaust & 15 Tooth Spline





BF 135.....2004 & Newer  
BF 150.....2004 & Newer

BF 200.....2002 & Newer

BF 225.....2002 & Newer

|  |      |       |          |         |      |       |          |  |      |       |          |                     |      |       |          |         |      |       |          |
|---|------|-------|----------|---------|------|-------|----------|--|------|-------|----------|---------------------|------|-------|----------|---------|------|-------|----------|
| 3-BLADE   |      |       |          | 4-BLADE |      |       |          | STD. 3-BLADE   |      |       |          | LG DIAMETER 3-BLADE |      |       |          | 4-BLADE |      |       |          |
| Dia.  | Rot. | Pitch | Part No. | Dia.    | Rot. | Pitch | Part No. | Dia.   | Rot. | Pitch | Part No. | Dia.                | Rot. | Pitch | Part No. | Dia.    | Rot. | Pitch | Part No. |
| 15-1/4  | R    | 15    | 992002   |         |      |       |          | 14-3/8   | R    | 15    | 993042   |                     |      |       |          |         |      |       |          |
|   |      |       |          |         |      |       |          | 14-3/8   | L    | 15    | 993052   |                     |      |       |          |         |      |       |          |
| 15  | R    | 17    | 992003   | 15      | R    | 16    | 992202   | 14-1/4   | R    | 17    | 993043   | 15-1/2              | R    | 17    | 993023   | 14-5/8  | R    | 16    | 993203   |
|   |      |       |          |         |      |       |          | 14-1/4   | L    | 17    | 993053   | 15-1/2              | L    | 17    | 993033   | 14-5/8  | L    | 16    | 993213   |
| 14-1/2  | R    | 19    | 992004   | 14-1/2  | R    | 18    | 992203   | 14-1/8   | R    | 19    | 993044   | 15-1/4              | R    | 19    | 993024   | 14-3/8  | R    | 18    | 993204   |
|   |      |       |          |         |      |       |          | 14-1/8   | L    | 19    | 993054   | 15-1/4              | L    | 19    | 993034   | 14-3/8  | L    | 18    | 993214   |
| 14-1/4  | R    | 21    | 992005   | 14      | R    | 20    | 992204   | 14   | R    | 21    | 993045   | 14-3/4              | R    | 21    | 993025   | 14-1/8  | R    | 20    | 993205   |
|   |      |       |          |         |      |       |          | 14   | L    | 21    | 993055   | 14-3/4              | L    | 21    | 993035   | 14-1/8  | L    | 20    | 993215   |
| 14  | R    | 23    | 992006   |         |      |       |          | 13-7/8   | R    | 23    | 993046   | 14-5/8              | R    | 23    | 993026   | 14      | R    | 22    | 993206   |
|   |      |       |          |         |      |       |          | 13-7/8   | L    | 23    | 993056   | 14-5/8              | L    | 23    | 993036   | 14      | L    | 22    | 993216   |

| Boat Description/Length |    |        |       |      |                |                      |  |      |       |          |                      |      |       |          |
|-------------------------|---|--------|-------|------|----------------|----------------------|--|------|-------|----------|----------------------|------|-------|----------|
|                         | ALUMINUM PROPELLERS   |        |       |      |                |                      | STAINLESS STEEL PROPELLERS   |      |       |          |                      |      |       |          |
|                         | Dia.  | Rot.   | Pitch | Bld# | OEM Part No.   | Part No.             | 3-BLADE BALLISTIC  |      |       |          | 3-BLADE BALLISTIC XL |      |       |          |
|                         |   |        |       |      |                |                      | Dia.   | Rot. | Pitch | Part No. | Dia.                 | Rot. | Pitch | Part No. |
| CR, HB                  | 16  | R      | 13    | 3    | 58130-ZY3-013A | 031022               |  |      |       |          |                      |      |       |          |
| 22'-25' - AL            | 16  | R      | 14    | 3    |                | 031050               |  |      |       |          |                      |      |       |          |
| 21'-24' - AL            | 15-1/4  | R      | 15    | 3    | 58130-ZY3-015A | 031023               | 14-7/8   | R    | 15    | 345131   |                      |      |       |          |
| 20'-23' - AL, SK        | 16  | R      | 16    | 3    |                | 031051               |  |      |       |          |                      |      |       |          |
| 19'-23' - AL, SK        | 14-1/2  | R      | 17    | 3    | 58130-ZY3-017A | 031024               | 14-3/4   | R    | 17    | 345132   |                      |      |       |          |
| 19'-23' - AL, SK        | 15  | R      | 17    | 3    |                | 031064               | 14-3/4   | L    | 17    | 345162   |                      |      |       |          |
| 19'-22' - AL, SK        | 15-1/2  | R      | 18    | 3    |                | 031052               |  |      |       |          |                      |      |       |          |
| 18'-22' - AL, SK        | 14  | R      | 19    | 3    | 58130-ZY3-019A | 031025               | 14-1/2   | R    | 19    | 345133   |                      |      |       |          |
| 18'-22' - AL, SK        | 14-1/2  | R      | 19    | 3    |                | 031065               | 14-1/2   | L    | 19    | 345163   |                      |      |       |          |
| 18'-20' - AL, SK        | 13-3/4  | R      | 21    | 3    | 58130-ZY3-021A | 031026               | 14-3/8   | R    | 21    | 345134   |                      |      |       |          |
| 18'-20' - AL, SK        | 14-1/4  | R      | 21    | 3    |                | 031066               | 14-3/8   | L    | 21    | 345164   |                      |      |       |          |
| 17'-20' - AL, SK        |   |        |       |      |                |                      | 14-1/4   | R    | 23    | 345135   |                      |      |       |          |
| 17'-20' - AL, SK        |   |        |       |      |                |                      | 14-1/4   | L    | 23    | 345165   |                      |      |       |          |
| Up to 18'               |   |        |       |      |                |                      | 14-1/4   | R    | 25    | 345136   |                      |      |       |          |
| High Performance        |   |        |       |      |                |                      |  |      |       |          | 14-1/2               | R    | 22    | 345141   |
| High Performance        |   |        |       |      |                |                      |  |      |       |          | 14-1/2               | R    | 24    | 345137   |
| High Perf. (EFI Engine) |   |        |       |      |                |                      |  |      |       |          | 14                   | R    | 24    | 345139   |
| High Performance        |   |        |       |      |                |                      |  |      |       |          | 14-1/2               | R    | 26    | 345138   |
| High Perf. (EFI Engine) |   |        |       |      |                |                      |  |      |       |          | 14                   | R    | 26    | 345140   |
| 4-BLADE MICHIGAN MATCH  |   |        |       |      |                | 4-BLADE BALLISTIC XL |  |      |       |          |                      |      |       |          |
| 21'-24' - AL, SK        |  | 15     | R     | 16   | 4              | 031080               |  |      |       |          |                      |      |       |          |
| 19'-23' - AL, SK        |  | 14-1/2 | R     | 18   | 4              | 031082               |  |      |       |          |                      |      |       |          |
| 18'-20' - AL, SK        |  | 14     | R     | 20   | 4              | 031084               |  |      |       |          |                      |      |       |          |
| 50-62 MPH               |   |        |       |      |                |                      |  |      |       |          | 13-3/4               | R    | 23    | 435135   |
| 55-67 MPH               |   |        |       |      |                |                      |  |      |       |          | 13-3/4               | R    | 25    | 435136   |
| 60-72 MPH               |   |        |       |      |                |                      |  |      |       |          | 13-3/4               | R    | 27    | 435137   |

Drop-In Hub  
Use XHS II® Hub Kit  
**207**  
Refer to Pages 40-41 for Details on Hub Kit Components.

Rubber Hub Bushing

HONDA

Key to Abbreviations: LL = Light Loads; SB = Sailboat; AL = All Loads; SK = Skiboat; WB = Workboat; HB = Houseboat; CR = Cruisers; HL = Heavy Loads; WD = Weedless

**4-10 HORSEPOWER**

Thru Hub Exhaust & 8 Tooth Spline

4 HP (Model 40) .....1973-1975                      7.5 HP (Model 75 / Model 7.5) ..... 1968-1985                      9.8 HP (Model 110 / Model 9.8)... 1968-1985  
 4.5 HP (Model 45 / Model 4.5) .....1973-1981

| <b>ALUMINUM PROPELLERS</b> |      |      |       |      |              |               |
|----------------------------|------|------|-------|------|--------------|---------------|
| Boat Description/Length    | Dia. | Rot. | Pitch | Bld# | OEM Part No. | Part No.      |
| Standard Replacement       | 9    | R    | 9     | 2    | 48-47922A10  | <b>032021</b> |
| 14'-16' - AL               | 9    | R    | 7     | 3    | 48-47670A10  | <b>032020</b> |



Rubber  
Hub  
Bushing

**6-15 HORSEPOWER • 2-1/2" GEARCASE**

Thru Hub Exhaust & 8 Tooth Spline

6 HP 2-Stroke (Includes Merc 6) .....1986-2002                      9.9 HP 4-Stroke (Not Bigfoot) ..... 1995-2004                      15 HP 2-Stroke ..... 1989-2005  
 8 HP 2-Stroke (Includes Merc 8) .....1986-2005                      10 HP .....1995 & Newer                      15 HP 4-Stroke ..... 1999-2006  
 8 HP 4-Stroke (Not Bigfoot) .....1995-2004                      10 HP (Sea Pro/Marathon) ..... 1995-2001  
 9.9 HP 2-Stroke (Includes Merc 9.9) .....1986-2005                      15 HP (Sea Pro/Marathon) ..... 1995-2001

| <b>ALUMINUM PROPELLERS</b> |       |      |        |      |              |               |
|----------------------------|-------|------|--------|------|--------------|---------------|
| Boat Description/Length    | Dia.  | Rot. | Pitch  | Bld# | OEM Part No. | Part No.      |
| 16'-20' - AL               | 9-1/4 | R    | 7      | 3    | 48-828152A12 | <b>032056</b> |
| 14'-18' - AL               | 9     | R    | 9      | 3    | 48-828156A12 | <b>032052</b> |
| 14'-16' - AL               | 9     | R    | 10-1/2 | 3    | 48-828158A12 | <b>032050</b> |



Rubber  
Hub  
Bushing

**8-9.9 HORSEPOWER (4-STROKE) • 2-1/2" GEARCASE**

Thru Hub Exhaust & 14 Tooth Spline

8 HP 4-Stroke (Not Bigfoot) .....2005 & Newer                      9.9 HP 4-Stroke (Not Bigfoot) .....2005 & Newer

| <b>ALUMINUM PROPELLERS</b> |      |      |       |      |              |               |
|----------------------------|------|------|-------|------|--------------|---------------|
| Boat Description/Length    | Dia. | Rot. | Pitch | Bld# | OEM Part No. | Part No.      |
| 12'-16' - AL               | 9.2  | R    | 8.4   | 3    |              | <b>142017</b> |



Rubber  
Hub  
Bushing

**20 HORSEPOWER**

Thru Hub Exhaust & 8 Tooth Spline

20 HP (Includes Merc 20 / Merc 200) ....1963-1981

| <b>ALUMINUM PROPELLERS</b> |       |      |       |      |              |               |
|----------------------------|-------|------|-------|------|--------------|---------------|
| Boat Description/Length    | Dia.  | Rot. | Pitch | Bld# | OEM Part No. | Part No.      |
| Standard Replacement       | 9-7/8 | R    | 11    | 2    | 48-33480A1   | <b>032135</b> |
| 14'-16' - AL               | 10    | R    | 9     | 3    | 48-86962A4   | <b>032136</b> |



Rubber  
Hub  
Bushing





**9.9-25 HORSEPOWER • 3" GEARCASE**

Thru Hub Exhaust & 10 Tooth Spline

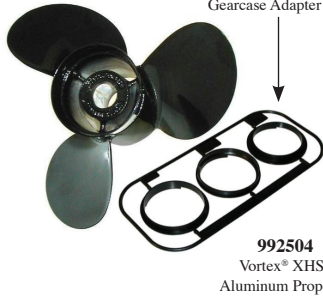
|   |   |   |
|---|---|---|
| 9.9 HP 4-Stroke Bigfoot/Sail .....1999-2005 | 20 HP 2-Stroke (Mercury®) ..... 1986-2002 | 25 HP 2-Stroke (Mariner®) .....1985 & Newer |
| 15 HP 4-Stroke Bigfoot/Sail .....1999-2005  | 25 HP 2-Stroke (Mercury®) ..... 1980-2005 | 25 HP (Sea Pro/Marathon).....All Years      |
| 18 HP (Mercury®) .....1980-1985             |   |   |

| Boat Description/Length | <br><b>ALUMINUM PROPELLERS</b> |      |       |      |              |          | Part No. | <br>991244 Gearcase Adapter Rings<br>992504 Vortex® XHS® Aluminum Propeller | Drop-In Hub<br>Use XHS® Hub Kit<br><b>120</b><br>MUST use Gearcase Adapter Ring supplied with propeller.<br>Refer to Pages 40-41 for Details on Hub Kit Components. |
|-------------------------|---|------|-------|------|--------------|----------|----------|---|---|
|                         | Dia.  | Rot. | Pitch | Bld# | OEM Part No. | Part No. |          |   |   |
|                         | 10-1/2  | R    | 9     | 3    |              |          | 992501   |   |   |
|                         | 10-1/2  | R    | 10    | 3    |              |          | 992502   |   |   |
| 15'-19'                 | 10-1/2  | R    | 11    | 3    | 48-19638A40  |          | 992503   |   |   |
| 13'-17'                 | 10-1/8  | R    | 12    | 3    | 48-19639A40  |          | 992504   |   |   |
| 13'-17'                 | 10-1/8  | R    | 13    | 3    | 48-19640A40  |          | 992505   |   |   |
| Up to 14'               | 10-1/8  | R    | 14    | 3    |              |          | 992506   |   |   |



  

| Boat Description/Length | <br><b>ALUMINUM PROPELLERS</b> |      |       |      |              |          | <br><b>STAINLESS STEEL PROPELLERS</b> |      |       |      |              |          | Rubber Hub Bushing |  |
|-------------------------|---|------|-------|------|--------------|----------|--|------|-------|------|--------------|----------|--------------------|--|
|                         | Dia.  | Rot. | Pitch | Bld# | OEM Part No. | Part No. | Dia.   | Rot. | Pitch | Bld# | OEM Part No. | Part No. |                    |  |
| 15'-19'                 | 10-3/8  | R    | 11    | 3    | 48-19638A40  | 031049   |  |      |       |      |              |          |                    |  |
| 13'-17'                 | 10-3/8  | R    | 13    | 3    | 48-19640A40  | 031048   | 10-1/8   | R    | 13    | 3    | 48-19644A5   | 305129   |                    |  |
| Up to 14'               |   |      |       |      |              |          | 10-1/8   | R    | 15    | 3    |              | 305130   |                    |  |

**15-25 HORSEPOWER • MARINER**

Non-Thru Hub Exhaust & Pin Drive



|                     |                       |                       |
|---------------------|-----------------------|-----------------------|
| 15 HP.....1976-1981 | W15 ..... 1977-1985   | 25 HP ..... 1977-1979 |
| 15A.....1979-1982   | 20 HP ..... 1976-1979 |                       |

| Boat Description/Length | <br><b>ALUMINUM PROPELLERS</b> |      |       |      |              |          | Part No. | <br>012011 | Rubber Hub Bushing |
|-------------------------|---|------|-------|------|--------------|----------|----------|---|--------------------|
|                         | Dia.  | Rot. | Pitch | Bld# | OEM Part No. | Part No. |          |   |                    |
| HB, SB                  | 9-1/4   | R    | 7     | 3    | 48-96628     | 012102   |          |   |                    |
| 12'-14' - HL            | 9   | R    | 9     | 3    |              | 012109   |          |   |                    |
| 12'-14' - HL            | 9   | R    | 10    | 3    | 48-96625     | 012011   |          |   |                    |
| 12'-14' - LL            | 9-1/4   | R    | 11    | 3    | 48-96623     | 012013   |          |   |                    |

**25-30 HORSEPOWER • MARINER • 3" GEARCASE**

Thru Hub Exhaust & 10 Tooth Spline

|                     |                       |                       |
|---------------------|-----------------------|-----------------------|
| 25 HP.....1980-1984 | 28 HP ..... 1976-1979 | 30 HP ..... 1979-1990 |
|---------------------|-----------------------|-----------------------|





| Boat Description/Length | <br><b>ALUMINUM PROPELLERS</b> |      |        |      |              |          | Part No. | <br>022001 | Rubber Hub Bushing |
|-------------------------|---|------|--------|------|--------------|----------|----------|---|--------------------|
|                         | Dia.  | Rot. | Pitch  | Bld# | OEM Part No. | Part No. |          |   |                    |
| 16'-18' - AL, SK        | 9-7/8   | R    | 9      | 3    | 48-81647     | 022001   |          |   |                    |
| 14'-17' - AL, SK        | 9-7/8   | R    | 10-1/2 | 3    | 48-81649     | 022002   |          |   |                    |
| 13'-16' - LL            | 9-7/8   | R    | 12     | 3    | 48-82826     | 022003   |          |   |                    |

**25-30 HORSEPOWER 4-STROKE • MERCURY • 3" GEARCASE**

Thru Hub Exhaust & 10 Tooth Spline

25 HP 4-Stroke (Not Bigfoot) .....2006 & Newer

30 HP 4-Stroke (Not Bigfoot) .....2006 & Newer

|                         |        |  |      |              |              |        |  |       |      |              |          | Drop-In Hub<br>Use XHS®<br>Hub Kit<br><b>122</b><br><br>MUST use Gearcase Adapter Ring supplied with propeller.<br><br>Refer to Pages 40-41 for Details on Hub Kit Components. |
|-------------------------|--------|---|------|--------------|--------------|--------|---|-------|------|--------------|----------|--|
| Boat Description/Length |        | ALUMINUM PROPELLERS   |      |              |              |        | STAINLESS STEEL PROPELLERS  |       |      |              |          |  |
| Dia.                    | Rot.   | Pitch   | Bld# | OEM Part No. | Part No.     | Dia.   | Rot.  | Pitch | Bld# | OEM Part No. | Part No. |  |
| 16'-20' - AL            | 10-1/2 | R   | 9    | 3            | 992501       |        |   |       |      |              |          |  |
| 14'-18' - AL            | 10-1/2 | R   | 10   | 3            | 992502       |        |   |       |      |              |          |  |
| 14'-18' - AL            | 10-1/2 | R   | 11   | 3            | 992503       |        |   |       |      |              |          |  |
| 14'-18' - AL            | 10-1/8 | R   | 12   | 3            | 992504       |        |   |       |      |              |          |  |
| 12'-16' - AL            | 10-1/8 | R   | 13   | 3            | 992505       |        |   |       |      |              |          |  |
| 12'-16' - AL            | 10-1/8 | R   | 14   | 3            | 992506       |        |   |       |      |              |          |  |
|                         |        |  |      |              |              |        |  |       |      |              |          | Rubber Hub Bushing   |
| Boat Description/Length |        | ALUMINUM PROPELLERS   |      |              |              |        | STAINLESS STEEL PROPELLERS  |       |      |              |          |  |
| Dia.                    | Rot.   | Pitch   | Bld# | OEM Part No. | Part No.     | Dia.   | Rot.  | Pitch | Bld# | OEM Part No. | Part No. |  |
| 16'-20' - AL            | 10.2   | R   | 8.3  | 3            | 48-896890A10 | 142020 |   |       |      |              |          |  |
| 12'-16' - AL            |        |   |      |              |              |        | 10-1/8  | R     | 13   | 3            | 305429   |  |
| 12'-16' - AL            |        |   |      |              |              |        | 10-1/8  | R     | 15   | 3            | 305430   |  |

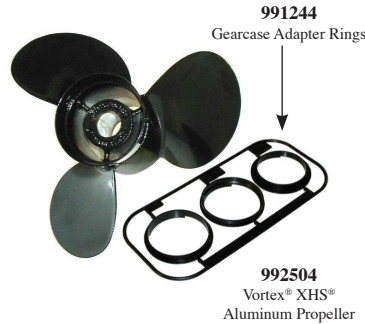

**40-65 HORSEPOWER • 3-1/4" GEARCASE**





Thru Hub Exhaust & 13 Tooth Spline

40 HP (Model 402) .....1974-1976

60 HP (Mariner®).....1976

65 HP (Model 650) ..... 1972-1976

50 HP (Model 500) .....1974-1976





|                         |        |   |          |              |            |                            |          |        |      |  |          |        |      |                            |      | Drop-In Hub<br>Use XHS®<br>Hub Kit<br><b>114</b><br><br>Refer to Pages 40-41 for Details on Hub Kit Components. |          |  |  |
|-------------------------|--------|---|----------|--------------|------------|----------------------------|----------|--------|------|---|----------|--------|------|----------------------------|------|---|----------|--|--|
| Boat Description/Length |        | 3-BLADE   |          |              |            | 3-BLADE LG. DIAMETER       |          |        |      | 4-BLADE   |          |        |      | STAINLESS STEEL PROPELLERS |      |   |          |  |  |
| Dia.                    | Rot.   | Pitch   | Part No. | Dia.         | Rot.       | Pitch                      | Part No. | Dia.   | Rot. | Pitch   | Part No. | Dia.   | Rot. | Pitch                      | Bld# | OEM Part No.  | Part No. |  |  |
|                         |        |   |          |              |            |                            |          | 11-1/2 | R    | 8   | 992401   |        |      |                            |      |   |          |  |  |
|                         |        |   |          | 12-1/4       | R          | 9                          | 992601   | 11-1/2 | R    | 9   | 992402   |        |      |                            |      |   |          |  |  |
|                         |        |   |          | 11-3/4       | R          | 10                         | 992602   | 11-1/2 | R    | 10  | 992403   |        |      |                            |      |   |          |  |  |
| 10-3/8                  | R      | 11  | 992404   | 11-5/8       | R          | 11                         | 992603   |        |      |   |          | 10-3/4 | R    | 12                         | 3    | 993405  |          |  |  |
| 10-3/8                  | R      | 12  | 992405   | 11-3/8       | R          | 12                         | 992604   |        |      |   |          | 10-1/2 | R    | 13                         | 3    | 993406  |          |  |  |
| 10-3/8                  | R      | 13  | 992406   | 11-1/8       | R          | 13                         | 992605   |        |      |   |          | 10-3/8 | R    | 14                         | 3    | 993407  |          |  |  |
| 10-3/8                  | R      | 14  | 992407   | 11-1/4       | R          | 14                         | 992606   |        |      |   |          | 10-1/8 | R    | 15                         | 3    | 993408  |          |  |  |
| 10                      | R      | 15  | 992408   |              |            |                            |          |        |      |   |          |        |      |                            |      |   |          |  |  |
| 10                      | R      | 16  | 992409   |              |            |                            |          |        |      |   |          |        |      |                            |      |   |          |  |  |
|                         |        |  |          |              |            |                            |          |        |      |  |          |        |      |                            |      | Rubber Hub Bushing<br><br>Use OEM<br>Fwd Washer 65758<br>Aft Washer 62124                                       |          |  |  |
| Boat Description/Length |        | ALUMINUM PROPELLERS   |          |              |            | STAINLESS STEEL PROPELLERS |          |        |      |   |          |        |      |                            |      |   |          |  |  |
| Dia.                    | Rot.   | Pitch   | Bld#     | OEM Part No. | Part No.   | Dia.                       | Rot.     | Pitch  | Bld# | OEM Part No.  | Part No. |        |      |                            |      |   |          |  |  |
| 19'-22' - AL            | 12-1/4 | R   | 9        | 3            | 48-61812A1 | 032046                     |          |        |      |   |          |        |      |                            |      |   |          |  |  |
| 19'-22' - AL            | 11-3/4 | R   | 10       | 3            |            | 032045                     |          |        |      |   |          |        |      |                            |      |   |          |  |  |
| 17'-19' - AL, SK        | 11-5/8 | R   | 11       | 3            | 48-61814A1 | 032044                     |          |        |      |   |          |        |      |                            |      |   |          |  |  |
| 16'-17' - AL, SK        | 11-3/8 | R   | 12       | 3            | 48-61816A1 | 032043                     |          |        |      |   |          |        |      |                            |      |   |          |  |  |
| 14'-16' - LL            | 11-1/8 | R   | 13       | 3            | 48-61818A1 | 032042                     | 10-1/8   | R      | 13   | 3   | 395929   |        |      |                            |      |   |          |  |  |
| 12'-14' - LL            | 11-1/4 | R   | 14       | 3            | 48-61820A1 | 032041                     |          |        |      |   |          |        |      |                            |      |   |          |  |  |
| 12'-14' - LL            | 11     | R   | 15       | 3            | 48-61822A1 | 032040                     | 10-1/8   | R      | 15   | 3   | 395930   |        |      |                            |      |   |          |  |  |



**25-70 HORSEPOWER • 3-1/4" GEARCASE**

Thru Hub Exhaust & 13 Tooth Spline • Vortex® & Apollo® Propellers are Not Compatible with Mercury's Reflex® Hub System.

|   |  |   |
|---|--|---|
| 25 HP 4-Stroke/Bigfoot .....1999-2005                 | 40 HP 4-Stroke (Not Bigfoot) .....1997 & Newer | 50 HP 4-Stroke (Not Bigfoot) .....1995 & Newer    |
| 30 HP 2-Stroke .....1994-2002                         | 40 HP (Sea Pro/Marathon) .....1977 & Newer     | 55 HP (Mercury/Sea Pro/Marathon) ....1995 & Newer |
| 30 HP 4-Stroke .....1999-2005                         | 45 HP .....1986-1989                           | 60 HP 2-Stroke .....1978 & Newer                  |
| 30 HP (Sea Pro/Marathon) .....1994 & Newer            | 48 HP (Mariner®).....All Years                 | 60 HP 4-Stroke (Not Bigfoot).....2001 & Newer     |
| 35 HP.....1984-1989                                   | 50 HP 2-Stroke (Includes Model 500) .....1977  | 70 HP (Includes Model 700).....Thru 1983          |
| 40 HP 2-Stroke (Includes Model 402) .....1977 & Newer |  |   |

|  |        |       |          |                      |              |          |          |         |       |  |              |          |      |       |      |              |          |
|---|--------|-------|----------|----------------------|--------------|----------|----------|---------|-------|---|--------------|----------|------|-------|------|--------------|----------|
| ALUMINUM PROPELLERS   |        |       |          |                      |              |          |          |         |       | STAINLESS STEEL PROPELLERS  |              |          |      |       |      |              |          |
| 3-BLADE   |        |       |          | 3-BLADE LG. DIAMETER |              |          |          | 4-BLADE |       |   |              |          |      |       |      |              |          |
| Dia.  | Rot.   | Pitch | Part No. | Dia.                 | Rot.         | Pitch    | Part No. | Dia.    | Rot.  | Pitch   | Part No.     | Dia.     | Rot. | Pitch | Bld# | OEM Part No. | Part No. |
|   |        |       |          |                      |              |          |          | 11-1/2  | R     | 8   | 992401       |          |      |       |      |              |          |
|   |        |       |          | 12-1/4               | R            | 9        | 992601   | 11-1/2  | R     | 9   | 992402       |          |      |       |      |              |          |
|   |        |       |          | 11-3/4               | R            | 10       | 992602   | 11-1/2  | R     | 10  | 992403       |          |      |       |      |              |          |
| 10-3/8  | R      | 11    | 992404   | 11-5/8               | R            | 11       | 992603   |         |       |   |              |          |      |       |      |              |          |
| 10-3/8  | R      | 12    | 992405   | 11-3/8               | R            | 12       | 992604   |         |       |   |              | 10-3/4   | R    | 12    | 3    | 48-855856A5  | 993405   |
| 10-3/8  | R      | 13    | 992406   | 11-1/8               | R            | 13       | 992605   |         |       |   |              | 10-1/2   | R    | 13    | 3    | 48-855858A5  | 993406   |
| 10-3/8  | R      | 14    | 992407   | 11-1/4               | R            | 14       | 992606   |         |       |   |              | 10-3/8   | R    | 14    | 3    | 48-855860A5  | 993407   |
| 10  | R      | 15    | 992408   |                      |              |          |          |         |       |   |              | 10-1/8   | R    | 15    | 3    | 48-855862A5  | 993408   |
| 10  | R      | 16    | 992409   |                      |              |          |          |         |       |   |              |          |      |       |      |              |          |
|  |        |       |          |                      |              |          |          |         |       |  |              |          |      |       |      |              |          |
| ALUMINUM PROPELLERS   |        |       |          |                      |              |          |          |         |       | STAINLESS STEEL PROPELLERS  |              |          |      |       |      |              |          |
| Boat Description/Length   | Dia.   | Rot.  | Pitch    | Bld#                 | OEM Part No. | Part No. | Dia.     | Rot.    | Pitch | Bld#  | OEM Part No. | Part No. |      |       |      |              |          |
| 19' & Up  | 12-1/2 | R     | 8        | 3                    | 48-42738A10  | 032141   |          |         |       |   |              |          |      |       |      |              |          |
| 19' & Up  | 12-1/4 | R     | 9        | 3                    |              | 032143   |          |         |       |   |              |          |      |       |      |              |          |
| 17'-19' - AL, SK  | 11-1/4 | R     | 10       | 3                    | 48-73132A40  | 031015   |          |         |       |   |              |          |      |       |      |              |          |
| 16'-18' - AL, SK  | 12     | R     | 10-1/2   | 3                    | 48-42740A10  | 032142   |          |         |       |   |              |          |      |       |      |              |          |
| 16'-18' - AL, SK  | 10-7/8 | R     | 11       | 3                    | 48-85632A40  | 031053   |          |         |       |   |              |          |      |       |      |              |          |
| 15'-17' - AL, SK  | 10-3/4 | R     | 12       | 3                    | 48-816702A40 | 031056   |          |         |       |   |              |          |      |       |      |              |          |
| 15'-17' - AL, SK  | 10-5/8 | R     | 12       | 3                    | 48-73134A40  | 031016   |          |         |       |   |              |          |      |       |      |              |          |
| 14'-17' - AL, SK  | 10-1/2 | R     | 13       | 3                    | 48-816704A40 | 031057   | 10-1/8   | R       | 13    | 3   |              | 395129   |      |       |      |              |          |
| 14'-17' - AL, SK  | 10-3/8 | R     | 13       | 3                    | 48-73136A40  | 031017   |          |         |       |   |              |          |      |       |      |              |          |
| 14'-16' - LL  | 10-3/8 | R     | 14       | 3                    | 48-816706A40 | 031058   |          |         |       |   |              |          |      |       |      |              |          |
| 14'-16' - LL  | 10-1/4 | R     | 14       | 3                    | 48-73138A40  | 031018   |          |         |       |   |              |          |      |       |      |              |          |
| 13'-15' - LL  | 10-1/8 | R     | 15       | 3                    | 48-73140A40  | 031019   | 10-1/8   | R       | 15    | 3   |              | 395130   |      |       |      |              |          |
| Up to 15'   | 10     | R     | 17       | 3                    | 48-73144A40  | 031020   |          |         |       |   |              |          |      |       |      |              |          |

Drop-In Hub  
Use XHS® Hub Kit  
**114**  
Refer to Pages 40-41 for Details on Hub Kit Components.

Rubber Hub Bushing

MERCURY / MARINER / SEA RAY



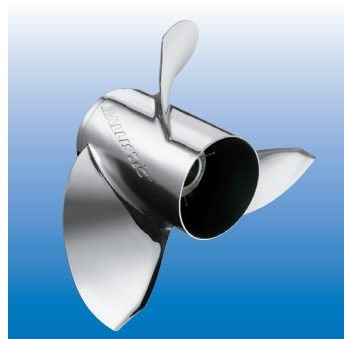





Key to Abbreviations: LL = Light Loads; SB = Sailboat; AL = All Loads; SK = Skiboat; WB = Workboat; HB = Houseboat; CR = Cruisers; HL = Heavy Loads; WD = Weedless

**40-140 HORSEPOWER • 4-1/4" GEARCASE**

Thru Hub Exhaust & 15 Tooth Spline

|   |   |  |
|---|---|--|
| 40 & 50 HP 4-Stroke / Bigfoot ..... All Years | 75 HP 4-Stroke ..... 2001 & Newer             | 90 HP 4-Stroke ..... 2001 & Newer                  |
| 60 HP 4-Stroke / Bigfoot ..... 1995 & Newer   | 80 HP ..... 1978-1989                         | 100 HP ..... 1988 & Newer                          |
| 60 HP (Sea Pro/Marathon) ..... 1995 & Newer   | 80 HP (Mariner®) ..... 1978-1983              | 115 HP (Yamaha®) ..... 1978-1983                   |
| 65 HP (Model 650 - 2 Cyl.) ..... Thru 1971    | 80 HP (Model 800; 2 & 4 Cyl.) ..... Thru 1977 | 115 HP 4-Stroke ..... 2001 & Newer                 |
| 65 HP (Model 650 - 4 Cyl.) ..... 1961-1970    | 80 HP (Yamaha®) ..... 1977-1983               | 125 HP ..... 1994-2005                             |
| 70 HP ..... 1987-1989                         | 85 HP (Model 850; 2 & 4 Cyl.) ..... Thru 1977 | 140 HP (Includes Sea Pro/Offshore) ..... 1978-1981 |
| 75 HP (Sea Pro/Marathon) ..... All Years      | 90 HP (Yamaha®) ..... 1978-1983               | 140 HP (Yamaha®) ..... 1978-1979                   |
| 75 HP 2-Stroke ..... 1984-2005                | 90 HP 2-Stroke ..... 1978 & Newer             | Models 900-1150-1500 ..... Thru 1977               |

| Boat Description/Length |  |      |       |      |              |          |  |      |       |          |                      |          |       |          |
|-------------------------|---|------|-------|------|--------------|----------|---|------|-------|----------|----------------------|----------|-------|----------|
|                         | ALUMINUM PROPELLERS   |      |       |      |              |          | STAINLESS STEEL PROPELLERS  |      |       |          |                      |          |       |          |
|                         | Dia.  | Rot. | Pitch | Bld# | OEM Part No. | Part No. | Dia.  | Rot. | Pitch | Bld#     | OEM Part No.         | Part No. |       |          |
| 25' & Up - AL           | 14  | R    | 10    | 3    | 48-854342A45 | 992109   |   |      |       |          |                      |          |       |          |
| 25' & Up - AL           | 14  | R    | 13    | 3    | 48-77340A45  | 992112   |   |      |       |          |                      |          |       |          |
| 19'-24' - AL, SK        | 13-3/4  | R    | 15    | 3    | 48-77342A45  | 992113   | 13-3/8  | R    | 15    | 3        |                      | 993143   |       |          |
| 19'-24' - AL, SK        |   |      |       |      |              |          | 13-3/8  | L    | 15    | 3        |                      | 993153   |       |          |
| 17'-20' - AL, SK        | 13-1/4  | R    | 17    | 3    | 48-77344A45  | 992114   | 13-1/4  | R    | 17    | 3        |                      | 993144   |       |          |
| 17'-20' - AL, SK        |   |      |       |      |              |          | 13-1/4  | L    | 17    | 3        |                      | 993154   |       |          |
| 16'-19' - AL, SK        | 13  | R    | 19    | 3    | 48-77346A45  | 992115   | 13-1/8  | R    | 19    | 3        |                      | 993145   |       |          |
| 16'-19' - AL, SK        |   |      |       |      |              |          | 13-1/8  | L    | 19    | 3        |                      | 993155   |       |          |
| 15'-18' - AL, SK        | 12-3/4  | R    | 21    | 3    | 48-77348A45  | 992116   | 13  | R    | 21    | 3        |                      | 993146   |       |          |
| 15'-18' - AL, SK        |   |      |       |      |              |          | 13  | L    | 21    | 3        |                      | 993156   |       |          |
| Boat Description/Length |  |      |       |      |              |          |  |      |       |          |                      |          |       |          |
|                         | ALUMINUM PROPELLERS   |      |       |      |              |          | 3-BLADE BALLISTIC   |      |       |          | 3-BLADE BALLISTIC XL |          |       |          |
|                         | Dia.  | Rot. | Pitch | Bld# | OEM Part No. | Part No. | Dia.  | Rot. | Pitch | Part No. | Dia.                 | Rot.     | Pitch | Part No. |
| 25' & Up - AL           | 14  | R    | 10    | 3    | 48-854342A45 | 031061   |   |      |       |          |                      |          |       |          |
| 25' & Up - AL           | 14  | R    | 11    | 3    | 48-77338A45  | 031054   |   |      |       |          |                      |          |       |          |
| Pontoon                 | 14  | R    | 11    | 3    | 48-77338CP1  | 031200   |   |      |       |          |                      |          |       |          |
| 25' & Up - AL           | 14  | R    | 12    | 3    |              | 031060   |   |      |       |          |                      |          |       |          |
| Pontoon                 | 14  | R    | 12    | 3    |              | 031201   |   |      |       |          |                      |          |       |          |
| 22' & Up - AL           | 14  | R    | 13    | 3    | 48-77340A45  | 031055   |   |      |       |          |                      |          |       |          |
| Pontoon                 | 14  | R    | 13    | 3    | 48-77340CP1  | 031202   |   |      |       |          |                      |          |       |          |
| 19'-24' - AL, SK        | 13-3/4  | R    | 15    | 3    | 48-77342A45  | 031041   | 13-5/8  | R    | 15    |          | 335130               |          |       |          |
| 17'-20' - AL, SK        | 13-1/4  | R    | 17    | 3    | 48-77344A45  | 031042   | 13-1/2  | R    | 17    |          | 335131               |          |       |          |
| 16'-19' - AL, SK        | 13  | R    | 19    | 3    | 48-77346A45  | 031043   | 13-3/8  | R    | 19    |          | 335132               |          |       |          |
| 15'-18' - AL, SK        | 12-3/4  | R    | 21    | 3    | 48-77348A45  | 031044   | 13-1/8  | R    | 21    |          | 335133               |          |       |          |
| High Performance        | 12-1/2  | R    | 23    | 3    | 48-77350A45  | 031045   |   |      |       |          | 13-1/2               | R        | 22    | 335134   |
| High Performance        |   |      |       |      |              |          |   |      |       |          | 13-1/2               | R        | 24    | 335135   |

**Drop-In Hub**  
 Use XHS II® Hub Kit  
**202**  
 USE Gearcase Adapter Ring supplied with propeller.  
 Refer to Pages 40-41 for Details on Hub Kit Components.

**Rubber Hub Bushing**  
 Use OEM Fwd Washer 13191A1 Tab Washer 11-816629 or MWM Fwd Washer 990332 or MWM Kit 9660-1 (Fwd Washer, Tab Washer, Propeller Nut)  
 See Page 24 for details.

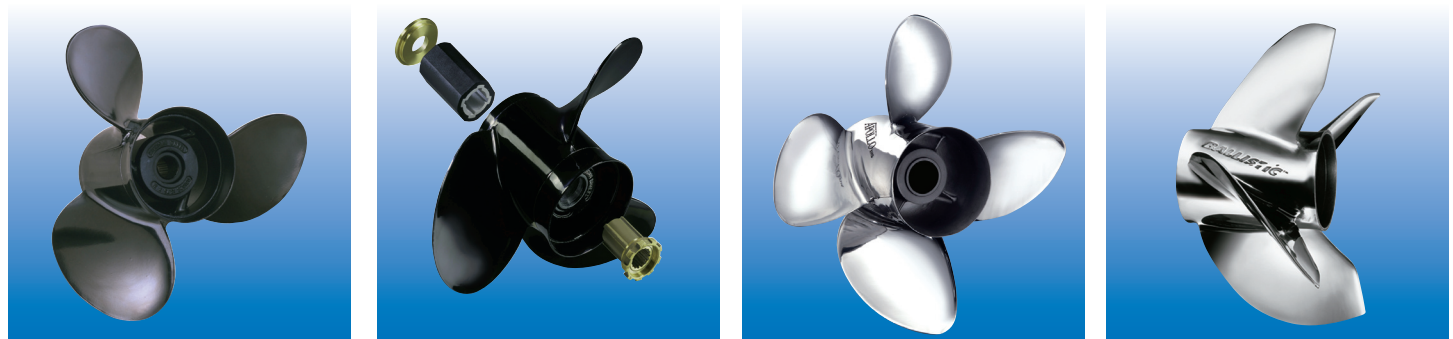

Key to Abbreviations: LL = Light Loads; SB = Sailboat; AL = All Loads; SK = Skiboat; WB = Workboat; HB = Houseboat; CR = Cruisers; HL = Heavy Loads; WD = Weedless

⊗ Limited Inventory Item.  
 ⊕ Pontoon Boat Propeller (Extended Cup)  
 \* To avoid damage or injury, replace standard trim tab with trim tab 822777A1.

**135-300 HORSEPOWER • V-6 (4-3/4") GEARCASE**







Thru Hub Exhaust & 15 Tooth Spline

135 HP.....1987 & Newer  
 150 HP.....1978 & Newer  
 150 HP (Yamaha®).....1979-1983  
 175 HP.....1978 & Newer  
 Add 4" Pitch for Twin Motors  
 Includes DFI, EFI, Magnum, Offshore,  
 Optimax, Sea Pro XRI, Marathon & Verado.

175 HP (Yamaha®).....1978-1979  
 200 HP.....1978 & Newer  
 220 HP.....1987-1988  
 225 HP.....1980 & Newer  
 225 HP (Sea Pro/Marathon).....All Years  
 250 HP.....1994 & Newer

275 HP.....1990-1994  
 300 HP.....1983; 1999 & Newer  
 3.4 Litre.....1984-1986

\*For engines 300 HP or higher, use "High HP Sleeve". See Page 41 for more details.

|  |   |        |          |  |              |              |          |                   |       |          |          |   |       |          |          |         |       |          |          |
|---|---|--------|----------|--|--------------|--------------|----------|-------------------|-------|----------|----------|---|-------|----------|----------|---------|-------|----------|----------|
| 3-BLADE   |   |        |          | 4-BLADE  |              |              |          | STD. 3-BLADE      |       |          |          | LG DIAMETER 3-BLADE   |       |          |          | 4-BLADE |       |          |          |
| Dia.  | Rot.  | Pitch  | Part No. | Dia.   | Rot.         | Pitch        | Part No. | Dia.              | Rot.  | Pitch    | Part No. | Dia.  | Rot.  | Pitch    | Part No. | Dia.    | Rot.  | Pitch    | Part No. |
| 15-1/4  | R   | 15     | 992002   |  |              |              |          | 14-3/8            | R     | 15       | ✳ 993042 |   |       |          |          |         |       |          |          |
|   |   |        |          |  |              |              |          | 14-3/8            | L     | 15       | ✳ 993052 |   |       |          |          |         |       |          |          |
| 15  | R   | 17     | 992003   | 15   | R            | 16           | 992202   | 14-1/4            | R     | 17       | ✳ 993043 | 15-1/2  | R     | 17       | ✳ 993023 | 14-5/8  | R     | 16       | ✳ 993203 |
|   |   |        |          |  |              |              |          | 14-1/4            | L     | 17       | ✳ 993053 | 15-1/2  | L     | 17       | ✳ 993033 | 14-5/8  | L     | 16       | ✳ 993213 |
| 14-1/2  | R   | 19     | 992004   | 14-1/2   | R            | 18           | 992203   | 14-1/8            | R     | 19       | ✳ 993044 | 15-1/4  | R     | 19       | ✳ 993024 | 14-3/8  | R     | 18       | ✳ 993204 |
|   |   |        |          |  |              |              |          | 14-1/8            | L     | 19       | ✳ 993054 | 15-1/4  | L     | 19       | ✳ 993034 | 14-3/8  | L     | 18       | ✳ 993214 |
| 14-1/4  | R   | 21     | 992005   | 14   | R            | 20           | 992204   | 14                | R     | 21       | ✳ 993045 | 14-3/4  | R     | 21       | ✳ 993025 | 14-1/8  | R     | 20       | ✳ 993205 |
|   |   |        |          |  |              |              |          | 14                | L     | 21       | ✳ 993055 | 14-3/4  | L     | 21       | ✳ 993035 | 14-1/8  | L     | 20       | ✳ 993215 |
| 14  | R   | 23     | 992006   |  |              |              |          | 13-7/8            | R     | 23       | ✳ 993046 | 14-5/8  | R     | 23       | ✳ 993026 | 14      | R     | 22       | ✳ 993206 |
|   |   |        |          |  |              |              |          | 13-7/8            | L     | 23       | ✳ 993056 | 14-5/8  | L     | 23       | ✳ 993036 | 14      | L     | 22       | ✳ 993216 |
|   |   |        |          |   |              |              |          |                   |       |          |          |  |       |          |          |         |       |          |          |
|   |   |        |          | ALUMINUM PROPELLERS  |              |              |          |                   |       |          |          | STAINLESS STEEL PROPELLERS  |       |          |          |         |       |          |          |
|   |   |        |          |  |              |              |          | 3-BLADE BALLISTIC |       |          |          | 3-BLADE BALLISTIC XL  |       |          |          |         |       |          |          |
| Boat Description/Length   | Dia.  | Rot.   | Pitch    | Bld#   | OEM Part No. | Part No.     | Dia.     | Rot.              | Pitch | Part No. | Dia.     | Rot.  | Pitch | Part No. | Dia.     | Rot.    | Pitch | Part No. |          |
| CR, HB  | 16  | R      | 13       | 3  | 48-78114A45  | 031022       |          |                   |       |          |          |   |       |          |          |         |       |          |          |
| 22'-25' - AL  | 16  | R      | 14       | 3  | 48-16438A45  | 031050       |          |                   |       |          |          |   |       |          |          |         |       |          |          |
| 21'-24' - AL  | 15-1/4  | R      | 15       | 3  | 48-78116A45  | 031023       | 14-7/8   | R                 | 15    | ✳ 345131 |          |   |       |          |          |         |       |          |          |
| 20'-23' - AL, SK  | 16  | R      | 16       | 3  | 48-16440A45  | 031051       |          |                   |       |          |          |   |       |          |          |         |       |          |          |
| 19'-23' - AL, SK  | 14-1/2  | R      | 17       | 3  | 48-78118A40  | 031024       | 14-3/4   | R                 | 17    | ✳ 345132 |          |   |       |          |          |         |       |          |          |
| 19'-23' - AL, SK  | 15  | R      | 17       | 3  | 48-832828A45 | 031064       | 14-3/4   | L                 | 17    | ✳ 345162 |          |   |       |          |          |         |       |          |          |
| 19'-22' - AL, SK  | 15-1/2  | R      | 18       | 3  | 48-11324A45  | 031052       |          |                   |       |          |          |   |       |          |          |         |       |          |          |
| 18'-22' - AL, SK  | 14  | R      | 19       | 3  | 48-78120A40  | 031025       | 14-1/2   | R                 | 19    | ✳ 345133 |          |   |       |          |          |         |       |          |          |
| 18'-22' - AL, SK  | 14-1/2  | R      | 19       | 3  | 48-832830A45 | 031065       | 14-1/2   | L                 | 19    | ✳ 345163 |          |   |       |          |          |         |       |          |          |
| 18'-20' - AL, SK  | 13-3/4  | R      | 21       | 3  | 48-78122A40  | 031026       | 14-3/8   | R                 | 21    | ✳ 345134 |          |   |       |          |          |         |       |          |          |
| 18'-20' - AL, SK  | 14-1/4  | R      | 21       | 3  | 48-832832A45 | 031066       | 14-3/8   | L                 | 21    | ✳ 345164 |          |   |       |          |          |         |       |          |          |
| 17'-20' - AL, SK  |   |        |          |  |              |              | 14-1/4   | R                 | 23    | ✳ 345135 |          |   |       |          |          |         |       |          |          |
| 17'-20' - AL, SK  |   |        |          |  |              |              | 14-1/4   | L                 | 23    | ✳ 345165 |          |   |       |          |          |         |       |          |          |
| Up to 18'   |   |        |          |  |              |              | 14-1/4   | R                 | 25    | ✳ 345136 |          |   |       |          |          |         |       |          |          |
| High Performance  |   |        |          |  |              |              |          |                   |       |          | 14-1/2   | R   | 22    | ✳ 345141 |          |         |       |          |          |
| High Performance  |   |        |          |  |              |              |          |                   |       |          | 14-1/2   | R   | 24    | ✳ 345137 |          |         |       |          |          |
| High Perf. (EFI Engine)   |   |        |          |  |              |              |          |                   |       |          | 14       | R   | 24    | ✳ 345139 |          |         |       |          |          |
| High Performance  |   |        |          |  |              |              |          |                   |       |          | 14-1/2   | R   | 26    | ✳ 345138 |          |         |       |          |          |
| High Perf. (EFI Engine)   |   |        |          |  |              |              |          |                   |       |          | 14       | R   | 26    | ✳ 345140 |          |         |       |          |          |
|   |   |        |          | 4-BLADE MICHIGAN MATCH   |              |              |          |                   |       |          |          | 4-BLADE BALLISTIC XL  |       |          |          |         |       |          |          |
| 21'-24' - AL, SK  |  | 15     | R        | 16   | 4            | 48-834850A45 | 031080   |                   |       |          |          |   |       |          |          |         |       |          |          |
| 19'-23' - AL, SK  |  | 14-1/2 | R        | 18   | 4            | 48-834852A45 | 031082   |                   |       |          |          |   |       |          |          |         |       |          |          |
| 18'-20' - AL, SK  |  | 14     | R        | 20   | 4            | 48-834854A45 | 031084   |                   |       |          |          |   |       |          |          |         |       |          |          |
| 50-62 MPH   |   |        |          |  |              |              |          |                   |       |          |          | 13-3/4  | R     | 23       | ✳ 435135 |         |       |          |          |
| 55-67 MPH   |   |        |          |  |              |              |          |                   |       |          |          | 13-3/4  | R     | 25       | ✳ 435136 |         |       |          |          |
| 60-72 MPH   |   |        |          |  |              |              |          |                   |       |          |          | 13-3/4  | R     | 27       | ✳ 435137 |         |       |          |          |

**Drop-In Hub**  
 Use XHS II®  
 Hub Kit  
**202**  
 Refer to Pages 40-41  
 for Details on Hub Kit  
 Components.

**Rubber Hub Bushing**  
 Use OEM  
 Fwd Washer 12-835467  
 Aft Washer 12-31211A3  
 Tab Washer 14-816629  
 or  
 MIWM Kit 990312  
 (Conductivity Washer,  
 Aft Washer)  
 or  
 MIWM Kit 9661-1  
 (Fwd Washer,  
 Conductivity Washer,  
 Aft Washer, Tab Washer,  
 Propeller Nut)  
 See Page 24 for details.

MERCURY /  
 MARINER / SEA RAY

Key to Abbreviations: LL = Light Loads; SB = Sailboat; AL = All Loads; SK = Skiboat; WB = Workboat; HB = Houseboat; CR = Cruisers; HL = Heavy Loads; WD = Weedless

\* To avoid damage or injury, replace standard trim tab with trim tab 822777A1.

## Replacing a Flo-Torq® Hub with Michigan Propellers

### Replacing a Flo-Torq® Drop In Hub Design with Michigan Propellers

Propellers supplied from Mercury®, Mariner® and Force® since 1996 come with the Flo-Torq® II drop in hubs equipped with attaching hardware A, B, C, F & G per the following illustrations. When switching to Michigan Match® or Ballistic® propellers, change the attaching hardware set-up as follows.

When converting to a Michigan Propeller on a **V-4 gearcase**, eliminate B & C, replace A with H and use existing hardware F & G.

When converting to a Michigan Propeller on a **V-6 gearcase**, eliminate B & C and use A, D, E, F & G as attaching hardware (D & E replace C). Be sure to use high-performance trim tab 822777A1 for stainless steel installations.

Michigan Wheel offers the following attaching hardware kits for these installations:

- 990312 Includes D & E for the V-6 gearcase.
- 990332 Includes Forward Thrust Washer H for V-4 gearcase.
- 9661-1 Includes A, D, E, F & G for the V-6 gearcase.
- 9660-1 Includes H, F & G for the V-4 gearcase.

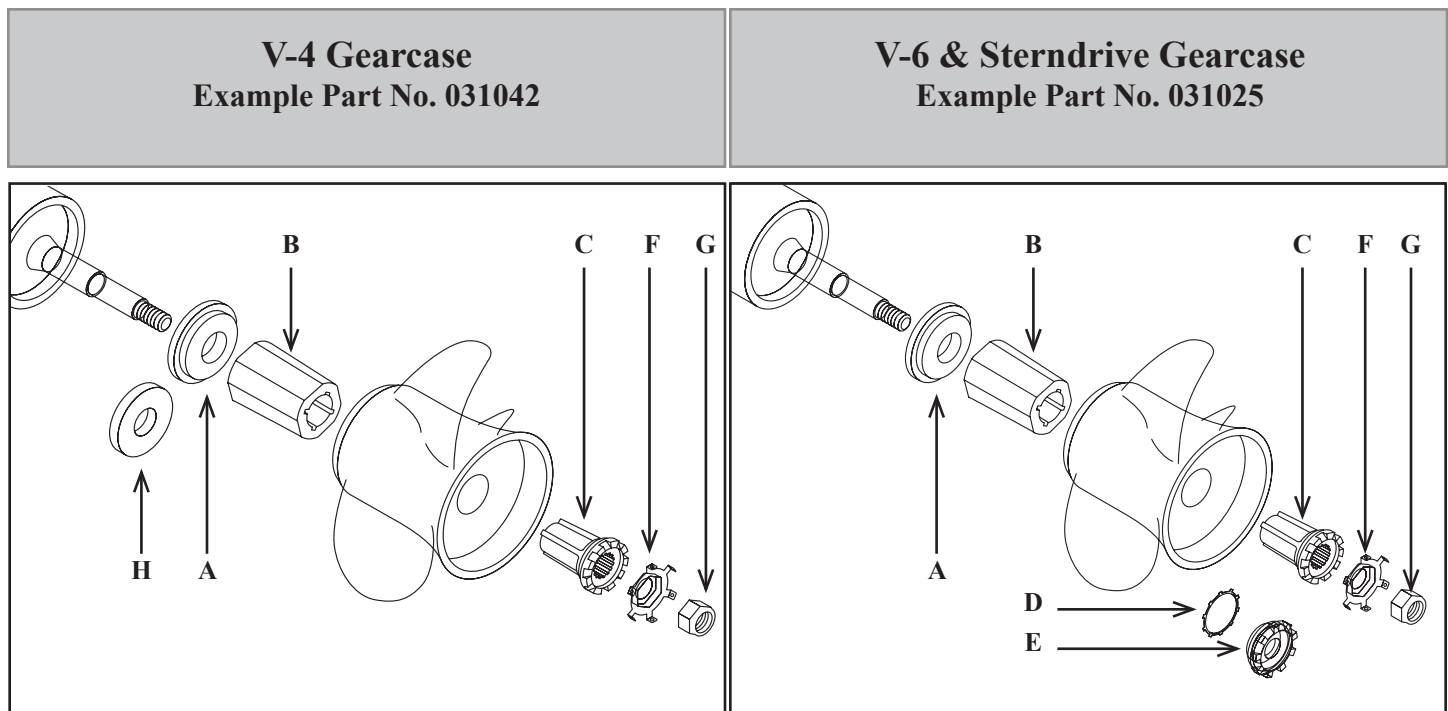

- A) 12-835467 Forward Thrust Washer
- B) 835290Q1 Plastic Drive Sleeve
- C) 826074-1 Metal Sleeve Adapter
- D) 13-42351-1 Conductivity (Star) Washer

- E) 12-31211A2 Aft Castle Thrust Washer
- F) 14-816629 Locking Tab Washer
- G) 11-827614 Shaft Propeller Nut
- H) 13191A1 Forward Thrust Washer

**9.9-20 HORSEPOWER • 2-1/2" GEARCASE**

Thru Hub Exhaust & 14 Tooth Spline

|                                    |                                   |                                   |
|------------------------------------|-----------------------------------|-----------------------------------|
| 9.9 HP 2-Stroke ..... 1984 & Newer | 15 HP 2-Stroke ..... 1985 & Newer | 18 HP 4-Stroke ..... 2001-2008    |
| 9.9 HP 4-Stroke ..... 2000-2003    | 15 HP 4-Stroke ..... 2000 & Newer | 20 HP 4-Stroke ..... 2007 & Newer |
| 12 HP ..... 1985-1988              | 18 HP 2-Stroke ..... 1985 & Newer |                                   |

| Boat Description/Length |  |      |       |      |              |          |
|-------------------------|---|------|-------|------|--------------|----------|
|                         | ALUMINUM PROPELLERS   |      |       |      |              |          |
|                         | Dia.  | Rot. | Pitch | Bld# | OEM Part No. | Part No. |
| 12'-16' - AL            | 9.2   | R    | 8.4   | 3    | 362-64102-0  | 142017   |



Rubber Hub Bushing

**25-30 HORSEPOWER • 3" GEARCASE**

Thru Hub Exhaust & 10 Tooth Spline

|                                   |                       |                                   |
|-----------------------------------|-----------------------|-----------------------------------|
| 25 HP ..... 1986-2001             | 30 HP ..... 1985-2001 | 30 HP 4-Stroke ..... 2002 & Newer |
| 25 HP 4-Stroke ..... 2002 & Newer |                       |                                   |

| Boat Description/Length |  |      |       |      |              |          |
|-------------------------|---|------|-------|------|--------------|----------|
|                         | ALUMINUM PROPELLERS   |      |       |      |              |          |
|                         | Dia.  | Rot. | Pitch | Bld# | OEM Part No. | Part No. |
| 16'-20' - AL            | 10-1/2  | R    | 9     | 3    |              | 992501   |
| 14'-18' - AL            | 10-1/2  | R    | 10    | 3    |              | 992502   |
| 14'-18' - AL            | 10-1/2  | R    | 11    | 3    |              | 992503   |
| 14'-18' - AL            | 10-1/8  | R    | 12    | 3    |              | 992504   |
| 12'-16' - AL            | 10-1/8  | R    | 13    | 3    |              | 992505   |
| 12'-16' - AL            | 10-1/8  | R    | 14    | 3    |              | 992506   |

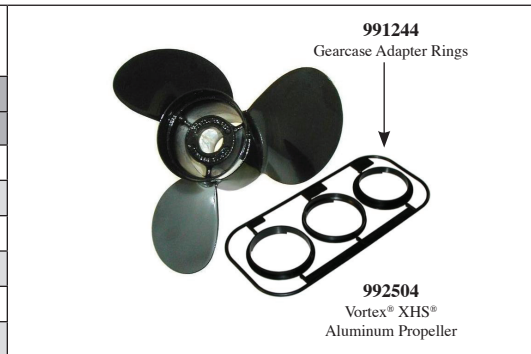

Drop-In Hub  
Use XHS® Hub Kit  
**122**  
MUST use Gearcase Adapter Ring supplied with propeller.  
Refer to Pages 40-41 for Details on Hub Kit Components.

| Boat Description/Length |  |      |       |      |              |          |
|-------------------------|--|------|-------|------|--------------|----------|
|                         | ALUMINUM PROPELLERS  |      |       |      |              |          |
|                         | Dia.   | Rot. | Pitch | Bld# | OEM Part No. | Part No. |
| 16'-20' - AL            | 10.2   | R    | 8.3   | 3    | 346-64106-5  | 142020   |
| 12'-16' - AL            |  |      |       |      |              |          |
| 12'-16' - AL            |  |      |       |      |              |          |

|  |      |       |      |              |          |  |
|---|------|-------|------|--------------|----------|--|
| STAINLESS STEEL PROPELLERS  |      |       |      |              |          |  |
| Dia.  | Rot. | Pitch | Bld# | OEM Part No. | Part No. |  |
|   |      |       |      |              |          |  |
|   |      |       |      |              |          |  |
|   |      |       |      |              |          |  |

Rubber Hub Bushing

**35-50 HORSEPOWER • 3-1/4" GEARCASE**

Thru Hub Exhaust & 13 Tooth Spline

|                                  |  |   |
|----------------------------------|--|---|
| 35 HP (35B Only) ..... Thru 1984 | 40 HP (Includes TLDI) ..... 1984 & Newer | 50 HP (Except 50C - Includes TLDI) ... 1992 & Newer |
|----------------------------------|--|---|

|  |      |       |          |                      |      |       |          |         |      |       |          |
|---|------|-------|----------|----------------------|------|-------|----------|---------|------|-------|----------|
| ALUMINUM PROPELLERS   |      |       |          |                      |      |       |          |         |      |       |          |
| 3-BLADE   |      |       |          | 3-BLADE LG. DIAMETER |      |       |          | 4-BLADE |      |       |          |
| Dia.  | Rot. | Pitch | Part No. | Dia.                 | Rot. | Pitch | Part No. | Dia.    | Rot. | Pitch | Part No. |
|   |      |       |          |                      |      |       |          | 11-1/2  | R    | 8     | 992401   |
|   |      |       |          | 12-1/4               | R    | 9     | 992601   | 11-1/2  | R    | 9     | 992402   |
|   |      |       |          | 11-3/4               | R    | 10    | 992602   | 11-1/2  | R    | 10    | 992403   |
| 10-3/8  | R    | 11    | 992404   | 11-5/8               | R    | 11    | 992603   |         |      |       |          |
| 10-3/8  | R    | 12    | 992405   | 11-3/8               | R    | 12    | 992604   |         |      |       |          |
| 10-3/8  | R    | 13    | 992406   | 11-1/8               | R    | 13    | 992605   |         |      |       |          |
| 10-3/8  | R    | 14    | 992407   | 11-1/4               | R    | 14    | 992606   |         |      |       |          |
| 10  | R    | 15    | 992408   |                      |      |       |          |         |      |       |          |
| 10  | R    | 16    | 992409   |                      |      |       |          |         |      |       |          |

|  |      |       |      |              |          |  |
|---|------|-------|------|--------------|----------|--|
| STAINLESS STEEL PROPELLERS  |      |       |      |              |          |  |
| Dia.  | Rot. | Pitch | Bld# | OEM Part No. | Part No. |  |
|   |      |       |      |              |          |  |
|   |      |       |      |              |          |  |
|   |      |       |      |              |          |  |
|   |      |       |      |              |          |  |
|   |      |       |      |              |          |  |
|   |      |       |      |              |          |  |

Drop-In Hub  
Use XHS® Hub Kit  
**116**  
Refer to Pages 40-41 for Details on Hub Kit Components.

| Boat Description/Length |  |      |       |      |              |          |
|-------------------------|---|------|-------|------|--------------|----------|
|                         | ALUMINUM PROPELLERS   |      |       |      |              |          |
|                         | Dia.  | Rot. | Pitch | Bld# | OEM Part No. | Part No. |
| 17'-21' - AL            | 10.6  | R    | 11.3  | 3    | 361-64113-0  | 142001   |





Rubber Hub Bushing

**50-70 HORSEPOWER • 3-1/4" GEARCASE**

Thru Hub Exhaust & 13 Tooth Spline

50 HP (50C Only) .....1987-1991                      60A ..... 1986-1999                      70A & 70B ..... 1981-1995  
 55 HP .....1981-1988

|  |      |       |          |                      |      |       |          |         |      |  |          |      |      |       |      |              |          |        |      | Drop-In Hub<br>Use XHS®<br>Hub Kit<br><b>112</b><br>Refer to Pages 40-41<br>for Details on Hub Kit<br>Components. |      |              |          |
|---|------|-------|----------|----------------------|------|-------|----------|---------|------|---|----------|------|------|-------|------|--------------|----------|--------|------|---|------|--------------|----------|
| ALUMINUM PROPELLERS   |      |       |          |                      |      |       |          |         |      | STAINLESS STEEL PROPELLERS  |          |      |      |       |      |              |          |        |      |   |      |              |          |
| 3-BLADE   |      |       |          | LG. DIAMETER 3-BLADE |      |       |          | 4-BLADE |      |   |          |      |      |       |      |              |          |        |      |   |      |              |          |
| Dia.  | Rot. | Pitch | Part No. | Dia.                 | Rot. | Pitch | Part No. | Dia.    | Rot. | Pitch   | Part No. | Dia. | Rot. | Pitch | Bld# | OEM Part No. | Part No. | Dia.   | Rot. | Pitch   | Bld# | OEM Part No. | Part No. |
|   |      |       |          |                      |      |       |          | 11-1/2  | R    | 8   | 992401   |      |      |       |      |              |          | 12-3/8 | R    | 15  | 3    |              | 325030   |
|   |      |       |          |                      |      |       |          | 11-1/2  | R    | 9   | 992402   |      |      |       |      |              |          |        |      |   |      |              |          |
|   |      |       |          |                      |      |       |          | 11-1/2  | R    | 10  | 992403   |      |      |       |      |              |          | 12     | R    | 17  | 3    |              | 325031   |
| 11-3/4  | R    | 13    | 992301   | 12-1/2               | R    | 13    | 992311   |         |      |   |          |      |      |       |      |              |          |        |      |   |      |              |          |
| 11-3/4  | R    | 15    | 992302   | 12-1/4               | R    | 15    | 992312   |         |      |   |          |      |      |       |      |              |          |        |      |   |      |              |          |
| 11-3/4  | R    | 17    | 992303   |                      |      |       |          |         |      |   |          |      |      |       |      |              |          |        |      |   |      |              |          |



**992303**  
Vortex® XHS®  
Aluminum Propeller





**992402**  
Vortex® XHS®  
Aluminum Propeller

**60-140 HORSEPOWER • 4-1/4" GEARCASE**

Thru Hub Exhaust & 15 Tooth Spline

60C (Large Gearcase) ..... Thru 1999                      90 HP ..... 1987-2001                      120 HP ..... 1988-2003  
 70C (Large Gearcase) ..... Thru 2002                      90 HP TLDI ..... 2001 & Newer                      140 HP ..... 1988-2003  
 70 HP TLDI ..... 2002-2009                      115 HP ..... 1992-2001  
 75 HP TLDI ..... 2010 & Newer                      115 HP TLDI ..... 2004 & Newer

|  |        |      |       |      |              |          |        |      |       |  |              |          |      |      |       |      |              |          |      | Drop-In Hub<br>Use XHS II®<br>Hub Kit<br><b>209</b><br>USE Gearcase Adapter<br>Ring supplied with<br>propeller.<br>Refer to Pages 40-41<br>for Details on Hub Kit<br>Components. |       |      |              |          |
|---|--------|------|-------|------|--------------|----------|--------|------|-------|---|--------------|----------|------|------|-------|------|--------------|----------|------|--|-------|------|--------------|----------|
| ALUMINUM PROPELLERS   |        |      |       |      |              |          |        |      |       | STAINLESS STEEL PROPELLERS  |              |          |      |      |       |      |              |          |      |  |       |      |              |          |
| Boat Description/Length   | Dia.   | Rot. | Pitch | Bld# | OEM Part No. | Part No. | Dia.   | Rot. | Pitch | Bld#  | OEM Part No. | Part No. | Dia. | Rot. | Pitch | Bld# | OEM Part No. | Part No. | Dia. | Rot.   | Pitch | Bld# | OEM Part No. | Part No. |
|   | 14     | R    | 10    | 3    |              | 992109   |        |      |       |   |              |          |      |      |       |      |              |          |      |  |       |      |              |          |
|   | 14     | R    | 13    | 3    | 3N4B645271   | 992112   |        |      |       |   |              |          |      |      |       |      |              |          |      |  |       |      |              |          |
| 19'-22' - AL, SK  | 13-3/4 | R    | 15    | 3    | 3N4B645321   | 992113   | 13-3/8 | R    | 15    | 3   | PT70115P15   | 993143   |      |      |       |      |              |          |      |  |       |      |              |          |
| 19'-22' - AL, SK  |        |      |       |      |              |          | 13-3/8 | L    | 15    | 3   |              | 993153   |      |      |       |      |              |          |      |  |       |      |              |          |
| 18'-21' - AL, SK  | 13-1/4 | R    | 17    | 3    | 3N4W645361   | 992114   | 13-1/4 | R    | 17    | 3   | NM889610170  | 993144   |      |      |       |      |              |          |      |  |       |      |              |          |
| 18'-21' - AL, SK  |        |      |       |      |              |          | 13-1/4 | L    | 17    | 3   |              | 993154   |      |      |       |      |              |          |      |  |       |      |              |          |
| 17'-20' - AL, SK  | 13     | R    | 19    | 3    | 3N4W645411   | 992115   | 13-1/8 | R    | 19    | 3   |              | 993145   |      |      |       |      |              |          |      |  |       |      |              |          |
| 17'-20' - AL, SK  |        |      |       |      |              |          | 13-1/8 | L    | 19    | 3   |              | 993155   |      |      |       |      |              |          |      |  |       |      |              |          |
| 15'-18' - AL, SK  | 12-3/4 | R    | 21    | 3    | 3N4W645451   | 992116   | 13     | R    | 21    | 3   |              | 993146   |      |      |       |      |              |          |      |  |       |      |              |          |
| 15'-18' - AL, SK  |        |      |       |      |              |          | 13     | L    | 21    | 3   |              | 993156   |      |      |       |      |              |          |      |  |       |      |              |          |

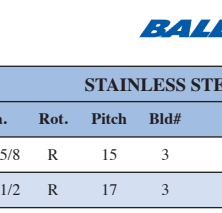

**335930**  
Ballistic®  
Stainless Steel Propeller

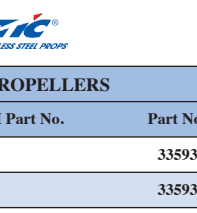

**335931**  
Ballistic®  
Stainless Steel Propeller

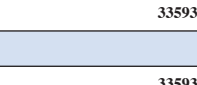

**335932**  
Ballistic®  
Stainless Steel Propeller

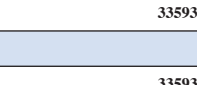

**335933**  
Ballistic®  
Stainless Steel Propeller

Key to Abbreviations: LL = Light Loads; SB = Sailboat; AL = All Loads; SK = Skiboat; WB = Workboat; HB = Houseboat; CR = Cruisers; HL = Heavy Loads; WD = Weedless

Ⓢ Limited Inventory Item.



**8-15 HORSEPOWER • 2-1/2" GEARCASE**

Thru Hub Exhaust & 10 Tooth Spline

|                                   |                                    |                                  |
|-----------------------------------|------------------------------------|----------------------------------|
| DF 8A 4-Stroke .....2011 & Newer  | DF 9.9A 4-Stroke .....2010 & Newer | DT 15C ..... 1989-1997           |
| DT 9.9 .....1983-1987             | DT 15..... 1983-1988               | DF 15 4-Stroke .....1996 & Newer |
| DF 9.9 4-Stroke..... 1996 & Newer |                                    |                                  |

|                         |       |                            |       |      |                 |               |  | <b>Rubber Hub Bushing</b> |
|-------------------------|-------|----------------------------|-------|------|-----------------|---------------|--|---------------------------|
|                         |       | <b>ALUMINUM PROPELLERS</b> |       |      |                 |               |  |                           |
| Boat Description/Length | Dia.  | Rot.                       | Pitch | Bld# | OEM Part No.    | Part No.      |  |                           |
| 14'-18' - AL            | 9-1/4 | R                          | 9     | 3    | 58100-93763-019 | <b>062016</b> |  |                           |

**25-30 HORSEPOWER • 3" GEARCASE**

Thru Hub Exhaust & 10 Tooth Spline

|                        |                               |                               |
|------------------------|-------------------------------|-------------------------------|
| DT 20 .....1987-1988   | DT 25C ..... 1989-2000        | DT 30 ☆ ..... 1983-1986       |
| DT 20 ☆ .....1985-1986 | DF 25 4-Stroke .....2000-2006 | DT 30C ..... 1987-1997        |
| DT 25 .....1987-1988   | DF 25 V-Twin.....2006 & Newer | DF 30 4-Stroke .....2000-2007 |
| DT 25 ☆ .....1985-1986 | DT 30..... 1987-1997          |                               |

|                         |        |                            |       |      |                 |               |  | <b>Drop-In Hub</b><br>Use XHS® Hub Kit <b>121</b><br><br>MUST use Gearcase Adapter Ring supplied with propeller.<br><br>Refer to Pages 40-41 for Details on Hub Kit Components. |
|-------------------------|--------|----------------------------|-------|------|-----------------|---------------|--|---|
|                         |        | <b>ALUMINUM PROPELLERS</b> |       |      |                 |               |  |   |
| Boat Description/Length | Dia.   | Rot.                       | Pitch | Bld# | OEM Part No.    | Part No.      |  |   |
| 20' & Up - AL           | 10-1/2 | R                          | 9     | 3    | 58100-96370-019 | <b>992501</b> |  |   |
| 18'-20' - AL            | 10-1/2 | R                          | 10    | 3    |                 | <b>992502</b> |  |   |
| 16'-18' - AL            | 10-1/2 | R                          | 11    | 3    | 58100-96420-019 | <b>992503</b> |  |   |
| 14'-16' - AL            | 10-1/8 | R                          | 12    | 3    | 58100-96480-019 | <b>992504</b> |  |   |
| 14'-16' - AL            | 10-1/8 | R                          | 13    | 3    | 58100-96490-019 | <b>992505</b> |  |   |
| 14'-16' - LL            | 10-1/8 | R                          | 14    | 3    |                 | <b>992506</b> |  |   |

|                         |        |                                   |       |      |              |               |  | <b>Rubber Hub Bushing</b> |
|-------------------------|--------|-----------------------------------|-------|------|--------------|---------------|--|---------------------------|
|                         |        | <b>STAINLESS STEEL PROPELLERS</b> |       |      |              |               |  |                           |
| Boat Description/Length | Dia.   | Rot.                              | Pitch | Bld# | OEM Part No. | Part No.      |  |                           |
| 14'-16' - AL            | 10-1/8 | R                                 | 13    | 3    |              | <b>305529</b> |  |                           |
| 14'-16' - AL            | 10-1/8 | R                                 | 15    | 3    |              | <b>305530</b> |  |                           |



SUZUKI



Key to Abbreviations: LL = Light Loads; SB = Sailboat; AL = All Loads; SK = Skiboat; WB = Workboat; HB = Houseboat; CR = Cruisers; HL = Heavy Loads; WD = Weedless

☆ Use stopper 57632-96400 (For rubber hub propeller only)



**35-65 HORSEPOWER • 3-1/4" GEARCASE**

Thru Hub Exhaust & 13 Tooth Spline

|                                  |                                  |                                  |
|----------------------------------|----------------------------------|----------------------------------|
| DT 35C.....1987-1989             | DT 50 & 50M.....1983-1984        | DT 60.....1983-1984              |
| DT 40.....1983-1998              | DF 50 4-Stroke.....1999-2010     | DF 60A 4-Stroke.....2010 & Newer |
| DF 40 4-Stroke.....1999-2010     | DF 50A 4-Stroke.....2011 & Newer | DT 65.....1985-1997              |
| DF 40A 4-Stroke.....2011 & Newer | DT 55.....1985-1997              |                                  |

|  |      |       |          |                      |      |       |          |  |      |       |          |        |      |       |      |              |          |
|---|------|-------|----------|----------------------|------|-------|----------|---|------|-------|----------|--------|------|-------|------|--------------|----------|
| ALUMINUM PROPELLERS   |      |       |          |                      |      |       |          | STAINLESS STEEL PROPELLERS  |      |       |          |        |      |       |      |              |          |
| 3-BLADE   |      |       |          | 3-BLADE LG. DIAMETER |      |       |          | 4-BLADE   |      |       |          |        |      |       |      |              |          |
| Dia.  | Rot. | Pitch | Part No. | Dia.                 | Rot. | Pitch | Part No. | Dia.  | Rot. | Pitch | Part No. | Dia.   | Rot. | Pitch | Bld# | OEM Part No. | Part No. |
|   |      |       |          |                      |      |       |          | 11-1/2  | R    | 8     | 992401   |        |      |       |      |              |          |
|   |      |       |          | 12-1/4               | R    | 9     | 992601   | 11-1/2  | R    | 9     | 992402   |        |      |       |      |              |          |
|   |      |       |          | 11-3/4               | R    | 10    | 992602   | 11-1/2  | R    | 10    | 992403   |        |      |       |      |              |          |
| 10-3/8  | R    | 11    | 992404   | 11-5/8               | R    | 11    | 992603   |   |      |       |          |        |      |       |      |              |          |
| 10-3/8  | R    | 12    | 992405   | 11-3/8               | R    | 12    | 992604   |   |      |       |          | 10-3/4 | R    | 12    | 3    |              | 993405   |
| 10-3/8  | R    | 13    | 992406   | 11-1/8               | R    | 13    | 992605   |   |      |       |          | 10-1/2 | R    | 13    | 3    |              | 993406   |
| 10-3/8  | R    | 14    | 992407   | 11-1/4               | R    | 14    | 992606   |   |      |       |          | 10-3/8 | R    | 14    | 3    |              | 993407   |
| 10  | R    | 15    | 992408   |                      |      |       |          |   |      |       |          | 10-1/8 | R    | 15    | 3    |              | 993408   |
| 10  | R    | 16    | 992409   |                      |      |       |          |   |      |       |          |        |      |       |      |              |          |

|  |        |      |       |      |                 |          |  |  |      |       |      |              |          |
|---|--------|------|-------|------|-----------------|----------|--|---|------|-------|------|--------------|----------|
| ALUMINUM PROPELLERS   |        |      |       |      |                 |          |  | STAINLESS STEEL PROPELLERS  |      |       |      |              |          |
| Boat Description/Length   | Dia.   | Rot. | Pitch | Bld# | OEM Part No.    | Part No. |  | Dia.  | Rot. | Pitch | Bld# | OEM Part No. | Part No. |
| 18'-21' - AL  | 12-1/4 | R    | 9     | 3    |                 | 032046   |  |   |      |       |      |              |          |
| 18'-21' - AL  | 11-3/4 | R    | 10    | 3    | 58100-95212-019 | 032045   |  |   |      |       |      |              |          |
| 17'-19' - AL  | 11-5/8 | R    | 11    | 3    | 58100-95222-019 | 032044   |  |   |      |       |      |              |          |
| 16'-18' - LL  | 11-3/8 | R    | 12    | 3    | 58100-95393-019 | 032043   |  |   |      |       |      |              |          |
| 14'-16' - LL  | 11-1/8 | R    | 13    | 3    | 58100-94313-019 | 032042   |  | 10-1/8  | R    | 13    | 3    |              | 395929   |
| 12'-14' - LL  | 11-1/4 | R    | 14    | 3    | 58100-95353-019 | 032041   |  |   |      |       |      |              |          |
| 12'-14' - LL  | 11     | R    | 15    | 3    | 58100-95363-019 | 032040   |  | 10-1/8  | R    | 15    | 3    |              | 395930   |

Drop-In Hub  
Use XHS® Hub Kit  
**115**



Refer to Pages 40-41 for Details on Hub Kit Components.

Rubber Hub Bushing

**60-140 HORSEPOWER • 4-1/4" GEARCASE**

Thru Hub Exhaust & 13 Tooth Spline

|                              |                      |                      |
|------------------------------|----------------------|----------------------|
| DF 60 4-Stroke.....1998-2009 | DT 85.....1979-2000  | DT 115.....1981-2001 |
| DF 70 4-Stroke.....1998-2008 | DT 90.....1989-1997  | DT 140.....1981-2001 |
| DT 75.....1983-1997          | DT 100.....1989-2000 |                      |

|  |        |      |       |      |                 |          |  |  |      |       |      |              |          |
|---|--------|------|-------|------|-----------------|----------|--|---|------|-------|------|--------------|----------|
| ALUMINUM PROPELLERS   |        |      |       |      |                 |          |  | STAINLESS STEEL PROPELLERS  |      |       |      |              |          |
| Boat Description/Length   | Dia.   | Rot. | Pitch | Bld# | OEM Part No.    | Part No. |  | Dia.  | Rot. | Pitch | Bld# | OEM Part No. | Part No. |
|   | 14     | R    | 10    | 3    |                 | 992109   |  |   |      |       |      |              |          |
|   | 14     | R    | 13    | 3    | 58100-99E00-019 | 992112   |  |   |      |       |      |              |          |
| 19'-22' - AL, SK  | 13-3/4 | R    | 15    | 3    | 58100-94500-019 | 992113   |  | 13-3/8  | R    | 15    | 3    |              | 993143   |
| 19'-22' - AL, SK  |        |      |       |      |                 |          |  | 13-3/8  | L    | 15    | 3    |              | 993153   |
| 18'-21' - AL, SK  | 13-1/4 | R    | 17    | 3    | 58100-94512-019 | 992114   |  | 13-1/4  | R    | 17    | 3    |              | 993144   |
| 18'-21' - AL, SK  |        |      |       |      |                 |          |  | 13-1/4  | L    | 17    | 3    |              | 993154   |
| 17'-20' - AL, SK  | 13     | R    | 19    | 3    | 58100-94522-019 | 992115   |  | 13-1/8  | R    | 19    | 3    |              | 993145   |
| 17'-20' - AL, SK  |        |      |       |      |                 |          |  | 13-1/8  | L    | 19    | 3    |              | 993155   |
| 15'-18' - AL, SK  | 12-3/4 | R    | 21    | 3    | 58100-94532-019 | 992116   |  | 13  | R    | 21    | 3    |              | 993146   |
| 15'-18' - AL, SK  |        |      |       |      |                 |          |  | 13  | L    | 21    | 3    |              | 993156   |

Drop-In Hub  
Use XHS II® Hub Kit  
**210**



Do NOT use Gearcase Adapter Ring supplied with propeller.

Refer to Pages 40-41 for Details on Hub Kit Components.

**70-140 HORSEPOWER (4-STROKE) • 4-1/4" GEARCASE**

Thru Hub Exhaust & 15 Tooth Spline

|                                   |                                   |                                   |
|-----------------------------------|-----------------------------------|-----------------------------------|
| DF 70A 4-Stroke .....2009 & Newer | DF 90 4-Stroke ..... 2001-2008    | DF 115 4-Stroke .....2001 & Newer |
| DF 80A 4-Stroke .....2009 & Newer | DF 100 4-Stroke .....2009 & Newer | DF 140 4-Stroke .....2002 & Newer |
| DF 90A 4-Stroke .....2009 & Newer |                                   |                                   |

| Boat Description/Length |  |      |       |      |              |          |  |      |       |      |              |          |
|-------------------------|---|------|-------|------|--------------|----------|---|------|-------|------|--------------|----------|
|                         | ALUMINUM PROPELLERS   |      |       |      |              |          | STAINLESS STEEL PROPELERS   |      |       |      |              |          |
|                         | Dia.  | Rot. | Pitch | Bld# | OEM Part No. | Part No. | Dia.  | Rot. | Pitch | Bld# | OEM Part No. | Part No. |
|                         | 14  | R    | 10    | 3    |              | 992109   |   |      |       |      |              |          |
| 24' & Up - AL           | 14  | R    | 13    | 3    |              | 992112   |   |      |       |      |              |          |
| 20'-24' - AL, SK        | 13-3/4  | R    | 15    | 3    |              | 992113   | 13-3/8  | R    | 15    | 3    |              | 993143   |
| 20'-24' - AL, SK        |   |      |       |      |              |          | 13-3/8  | L    | 15    | 3    |              | 993153   |
| 17'-19' - AL, SK        | 13-1/4  | R    | 17    | 3    |              | 992114   | 13-1/4  | R    | 17    | 3    |              | 993144   |
| 17'-19' - AL, SK        |   |      |       |      |              |          | 13-1/4  | L    | 17    | 3    |              | 993154   |
| 16'-18' - AL, SK        | 13  | R    | 19    | 3    |              | 992115   | 13-1/8  | R    | 19    | 3    |              | 993145   |
| 16'-18' - AL, SK        |   |      |       |      |              |          | 13-1/8  | L    | 19    | 3    |              | 993155   |
| 15'-18' - AL, SK        | 12-3/4  | R    | 21    | 3    |              | 992116   | 13  | R    | 21    | 3    |              | 993146   |
| 15'-18' - AL, SK        |   |      |       |      |              |          | 13  | L    | 21    | 3    |              | 993156   |

**Drop-In Hub**  
 Use XHS II® Hub Kit  
**225 / 226**  
**/ 227\***  
 USE Gearcase Adapter Ring supplied with propeller.  
 Refer to Pages 40-41 for Details on Hub Kit Components.  
 \* XHS II® 227 HUB KIT NOT AVAILABLE IN SOLID HUB.

Note: For DF 90 / DF 100 / DF 115 HP 4-Stroke engine applications use XHS II® (Drop-In Hub) Kit #225.  
 For DF 140 HP 4-Stroke engine applications use XHS II® (Drop-In Hub) Kit #226.  
 For DF 70A / 80A / 90A applications use XHS II® (Drop-In Hub) Kit #227.

| Boat Description/Length |  |      |       |      |                 |          |
|-------------------------|---|------|-------|------|-----------------|----------|
|                         | ALUMINUM PROPELLERS   |      |       |      |                 |          |
|                         | Dia.  | Rot. | Pitch | Bld# | OEM Part No.    | Part No. |
| 20'-24' - AL, SK        | 14  | R    | 15    | 3    | 58100-90J41-019 | 061020   |
| 17'-19' - AL, SK        | 14  | R    | 17    | 3    | 58100-90J01-019 | 061024   |
| 16'-18' - AL, SK        | 14  | R    | 19    | 3    | 58100-90J11-019 | 061028   |
| 15'-18' - AL, SK        | 14  | R    | 21    | 3    | 58100-90J21-019 | 061032   |



Michigan Match® Aluminum Propeller



**Rubber Hub Bushing**

**150-300 HORSEPOWER • 4-3/4" GEARCASE**

Thru Hub Exhaust & 15 Tooth Spline

|                                   |                                    |                                    |
|-----------------------------------|------------------------------------|------------------------------------|
| DT 150 .....1986-2003             | DT 200 ..... 1986-2000             | DF 225 4-StrokeⓄ .....2004 & Newer |
| DF 150 4-Stroke .....2006 & Newer | DF 200 4-StrokeⓄ .....2004 & Newer | DF 250 4-StrokeⓄ .....2004 & Newer |
| DT 175 .....1987-1992             | DT 225 ..... 1986-2003             | DF 300 4-StrokeⓄ .....2007 & Newer |
| DF 175 4-Stroke .....2006 & Newer |                                    |                                    |

Ⓞ Listed propeller diameters are slightly less than original equipment propeller.



|  |      |         |          |  |      |       |          |                     |      |       |          |         |      |       |          |
|---|------|---------|----------|--|------|-------|----------|---------------------|------|-------|----------|---------|------|-------|----------|
| 3-BLADE   |      | 4-BLADE |          | STD. 3-BLADE   |      |       |          | LG DIAMETER 3-BLADE |      |       |          | 4-BLADE |      |       |          |
| Dia.  | Rot. | Pitch   | Part No. | Dia.   | Rot. | Pitch | Part No. | Dia.                | Rot. | Pitch | Part No. | Dia.    | Rot. | Pitch | Part No. |
| 15-1/4  | R    | 15      | 992002   |  |      |       |          | 14-3/8              | R    | 15    | 993042   |         |      |       |          |
|   |      |         |          |  |      |       |          | 14-3/8              | L    | 15    | 993052   |         |      |       |          |
| 15  | R    | 17      | 992003   | 15   | R    | 16    | 992202   | 14-1/4              | R    | 17    | 993043   | 15-1/2  | R    | 17    | 993023   |
|   |      |         |          |  |      |       |          | 14-1/4              | L    | 17    | 993053   | 15-1/2  | L    | 17    | 993033   |
| 14-1/2  | R    | 19      | 992004   | 14-1/2   | R    | 18    | 992203   | 14-1/8              | R    | 19    | 993044   | 15-1/4  | R    | 19    | 993024   |
|   |      |         |          |  |      |       |          | 14-1/8              | L    | 19    | 993054   | 15-1/4  | L    | 19    | 993034   |
| 14-1/4  | R    | 21      | 992005   | 14   | R    | 20    | 992204   | 14                  | R    | 21    | 993045   | 14-3/4  | R    | 21    | 993025   |
|   |      |         |          |  |      |       |          | 14                  | L    | 21    | 993055   | 14-3/4  | L    | 21    | 993035   |
| 14  | R    | 23      | 992006   |  |      |       |          | 13-7/8              | R    | 23    | 993046   | 14-5/8  | R    | 23    | 993026   |
|   |      |         |          |  |      |       |          | 13-7/8              | L    | 23    | 993056   | 14-5/8  | L    | 23    | 993036   |

**Drop-In Hub**  
 Use XHS II® Hub Kit  
**204**  
 Refer to Pages 40-41 for Details on Hub Kit Components.

**6-8 HORSEPOWER**

Thru Hub Exhaust & 7 Tooth Spline



6 HP 2-Stroke .....1986-2000                      8 HP 2-Stroke ..... 1986-2009                      8 HP 4-Stroke .....2001 & Newer  
 6 HP 4-Stroke .....2001-2010

| Boat Description/Length |  |      |       |      |                 |               | <br><b>102002</b> | Rubber<br>Hub<br>Bushing |
|-------------------------|---|------|-------|------|-----------------|---------------|--|--------------------------|
|                         | <b>ALUMINUM PROPELLERS</b>  |      |       |      |                 |               |  |                          |
|                         | Dia.  | Rot. | Pitch | Bld# | OEM Part No.    | Part No.      |  |                          |
| General Usage           | 8-1/2   | R    | 7-1/2 | 3    | 6G1-45943-00-EL | <b>102002</b> |  |                          |

**8 HORSEPOWER**

Non-Thru Hub Exhaust & Pin Drive



8 HP.....1976-1983

| Boat Description/Length |  |      |       |      |              |               | <br><b>012008</b> | Rubber<br>Hub<br>Bushing |
|-------------------------|---|------|-------|------|--------------|---------------|--|--------------------------|
|                         | <b>ALUMINUM PROPELLERS</b>  |      |       |      |              |               |  |                          |
|                         | Dia.  | Rot. | Pitch | Bld# | OEM Part No. | Part No.      |  |                          |
| 14'-16' - AL            | 8-1/4   | R    | 8     | 3    |              | <b>012008</b> |  |                          |

**9.9-20 HORSEPOWER • 2-1/2" GEARCASE**

Thru Hub Exhaust & 8 Tooth Spline



9.9 HP 2-Stroke .....1984-2009                      15 HP 2-Stroke ..... 1984-2009                      F15 C .....2007 & Newer  
 9.9 HP 4-Stroke ..... 1986 & Newer                      15 HP 4-Stroke ..... 1998 & Newer                      20 HP 4-Stroke .....2007 & Newer

| Boat Description/Length |  |      |        |      |                 |               | <br><b>102003</b> | Rubber<br>Hub<br>Bushing |
|-------------------------|---|------|--------|------|-----------------|---------------|---|--------------------------|
|                         | <b>ALUMINUM PROPELLERS</b>  |      |        |      |                 |               |   |                          |
|                         | Dia.  | Rot. | Pitch  | Bld# | OEM Part No.    | Part No.      |   |                          |
| 13'-17' - HL            | 9-1/4   | R    | 8      | 3    | 63V-45947-00-EL | <b>102003</b> |   |                          |
| 12'-15' - AL            | 9-1/4   | R    | 9      | 3    | 63V-45945-10-EL | <b>102004</b> |   |                          |
| 12'-15' - AL            | 9-1/4   | R    | 10-1/2 | 3    | 683-45943-00-EL | <b>102005</b> |   |                          |

**15-28 HORSEPOWER**

Non-Thru Hub Exhaust & Pin Drive

15A & W15 HP .....1976-1983                      25 HP 2 Cyl. .... 1977-1979                      28 HP ..... 1976-1978  
 20 HP.....1976-1978

| Boat Description/Length |  |      |       |      |                 |               | <br><b>012011</b> | Rubber<br>Hub<br>Bushing |
|-------------------------|---|------|-------|------|-----------------|---------------|--|--------------------------|
|                         | <b>ALUMINUM PROPELLERS</b>  |      |       |      |                 |               |  |                          |
|                         | Dia.  | Rot. | Pitch | Bld# | OEM Part No.    | Part No.      |  |                          |
| HB, SB                  | 9-1/4   | R    | 7     | 3    | 650-45943-01-36 | <b>012102</b> |  |                          |
| 12'-14' - HL            | 9   | R    | 9     | 3    |                 | <b>012109</b> |  |                          |
| 12'-14' - HL            | 9   | R    | 10    | 3    | 651-45947-00-36 | <b>012011</b> |  |                          |
| 12'-14' - AL            | 9-1/4   | R    | 11    | 3    | 653-45941-01-36 | <b>012013</b> |  |                          |



**50-130 HORSEPOWER • 4-1/4" GEARCASE**

Thru Hub Exhaust & 15 Tooth Spline

|  |  |  |
|--|--|--|
| T50 HP.....1996 & Newer                    | 75 HP (Includes C75/E75/P75) ..... 1994-1999 | 90 HP (Includes C90) .....1984 & Newer   |
| 60 HP (Includes C60/E60/P60).....1992-2005 | 80 HP.....1997                               | F100 4-Stroke ..... 1999-2002            |
| F70 4-Stroke.....2010 & Newer              | F80 4-Stroke..... 1999-2002                  | F115 4-Stroke .....2000 & Newer          |
| 70 HP.....1984 & Newer                     | 85 HP..... 1991-1997                         | 115 HP (Includes C115/P115) 1984 & Newer |
| F75 4-Stroke.....2003 & Newer              | F90 4-Stroke..... 1999 & Newer               | 130 HP ..... 1984-2003                   |

| Boat Description/Length |                     |      |       |      |              |               |                            |      |       |      |                 |                 |
|-------------------------|---------------------|------|-------|------|--------------|---------------|----------------------------|------|-------|------|-----------------|-----------------|
|                         | ALUMINUM PROPELLERS |      |       |      |              |               | STAINLESS STEEL PROPELLERS |      |       |      |                 |                 |
|                         | Dia.                | Rot. | Pitch | Bld# | OEM Part No. | Part No.      | Dia.                       | Rot. | Pitch | Bld# | OEM Part No.    | Part No.        |
| 25' & Up- AL            | 14                  | R    | 10    | 3    |              | <b>992109</b> |                            |      |       |      |                 |                 |
| 22'-25' - AL            | 14                  | R    | 13    | 3    |              | <b>992112</b> |                            |      |       |      |                 |                 |
| 20'-24' - AL, SK        | 13-3/4              | R    | 15    | 3    |              | <b>992113</b> | 13-3/8                     | R    | 15    | 3    |                 | ※ <b>993143</b> |
| 20'-24' - AL, SK        |                     |      |       |      |              |               | 13-3/8                     | L    | 15    | 3    |                 | ※ <b>993153</b> |
| 17'-19' - AL, SK        | 13-1/4              | R    | 17    | 3    |              | <b>992114</b> | 13-1/4                     | R    | 17    | 3    | 688-45930-02-98 | ※ <b>993144</b> |
| 17'-19' - AL, SK        |                     |      |       |      |              |               | 13-1/4                     | L    | 17    | 3    |                 | ※ <b>993154</b> |
| 16'-18' - AL, SK        | 13                  | R    | 19    | 3    |              | <b>992115</b> | 13-1/8                     | R    | 19    | 3    | 688-45970-03-98 | ※ <b>993145</b> |
| 16'-18' - AL, SK        |                     |      |       |      |              |               | 13-1/8                     | L    | 19    | 3    |                 | ※ <b>993155</b> |
| 15'-18' - AL, SK        | 12-3/4              | R    | 21    | 3    |              | <b>992116</b> | 13                         | R    | 21    | 3    | 688-45972-02-98 | ※ <b>993146</b> |
| 15'-18' - AL, SK        |                     |      |       |      |              |               | 13                         | L    | 21    | 3    |                 | ※ <b>993156</b> |

**Drop-In Hub**  
Use XHS II® Hub Kit  
**203 / 208**  
USE Gearcase Adapter Ring supplied with propeller.  
Refer to Pages 40-41 for Details on Hub Kit Components.

Note: For 115 HP, F115 (4-Stroke), and 130 HP engine applications use XHS II® (Drop-In Hub) Kit #203.  
For all other engine applications use XHS II® (Drop-In Hub) Kit #208.

| Boat Description/Length |                     |      |       |      |                 |               |                            |       |          |               |                      |       |          |               |  |
|-------------------------|---------------------|------|-------|------|-----------------|---------------|----------------------------|-------|----------|---------------|----------------------|-------|----------|---------------|--|
|                         | ALUMINUM PROPELLERS |      |       |      |                 |               | STAINLESS STEEL PROPELLERS |       |          |               |                      |       |          |               |  |
|                         | Dia.                | Rot. | Pitch | Bld# | OEM Part No.    | Part No.      | 3-BLADE BALLISTIC          |       |          |               | 3-BLADE BALLISTIC XL |       |          |               |  |
| Dia.                    |                     |      |       |      |                 |               | Rot.                       | Pitch | Part No. | Dia.          | Rot.                 | Pitch | Part No. |               |  |
| 25' & Up- AL            | 14                  | R    | 11    | 3    | 6E5-45954-00-EL | <b>101036</b> |                            |       |          |               |                      |       |          |               |  |
| 22'-25' - AL            | 13-5/8              | R    | 13    | 3    | 6E5-45949-00-EL | <b>101031</b> |                            |       |          |               |                      |       |          |               |  |
| 20'-24' - AL, SK        | 13-1/2              | R    | 15    | 3    | 6E5-45947-00-EL | <b>101032</b> | 13-5/8                     | R     | 15       | <b>335930</b> |                      |       |          |               |  |
| 17'-19' - AL, SK        | 13-1/4              | R    | 17    | 3    | 6E5-45945-01-EL | <b>101033</b> | 13-1/2                     | R     | 17       | <b>335931</b> |                      |       |          |               |  |
| 16'-18' - AL, SK        | 13                  | R    | 19    | 3    | 6E5-45941-00-EL | <b>101034</b> | 13-3/8                     | R     | 19       | <b>335932</b> |                      |       |          |               |  |
| 15'-18' - AL, SK        | 12-5/8              | R    | 21    | 3    | 6E5-45943-00-EL | <b>101035</b> | 13-1/8                     | R     | 21       | <b>335933</b> |                      |       |          |               |  |
| High Performance        |                     |      |       |      |                 |               |                            |       |          |               | 13-1/2               | R     | 22       | <b>335934</b> |  |
| High Performance        |                     |      |       |      |                 |               |                            |       |          |               | 13-1/2               | R     | 24       | <b>335935</b> |  |

**Rubber Hub Bushing**

**80-140 HORSEPOWER**

Thru Hub Exhaust & 15 Tooth Spline

|                     |                            |                        |
|---------------------|----------------------------|------------------------|
| 80 HP.....1977-1983 | 90 & 115 HP..... 1978-1983 | 140 HP ..... 1978-1979 |
|---------------------|----------------------------|------------------------|

**See Mercury® 40-140 HP Product Offering on Page 22.**

**150-175 HORSEPOWER**

Thru Hub Exhaust & 15 Tooth Spline

|                      |                       |
|----------------------|-----------------------|
| 150 HP.....1979-1983 | 175 HP..... 1978-1979 |
|----------------------|-----------------------|

**See Mercury® V-6 Product Offering on Page 23.**

Key to Abbreviations: LL = Light Loads; SB = Sailboat; AL = All Loads; SK = Skiboat; WB = Workboat; HB = Houseboat; CR = Cruisers; HL = Heavy Loads; WD = Weedless

※ Trim Tab 6E5-45371-10-00 is required when using the Apollo propeller on Yamaha V-4 engines, 50-130 HP.

**150-300 HORSEPOWER • 4-3/4" GEARCASE**

Thru Hub Exhaust & 15 Tooth Spline

150 HP.....1986 & Newer  
 F150 4-Stroke.....2004 & Newer  
 175 HP.....1984 & Newer  
 200 HP.....1984 & Newer  
 200 HP VMAX®.....2001  
 F200 4-Stroke.....2002 & Newer  
 VF200 V MAX® SHO.....2010 & Newer

220 HP (Special) .....1984-1985  
 225 HP (Excel).....1987-1988  
 225 HP.....1986 & Newer  
 F225 4-Stroke.....2002 & Newer  
 VF225 V MAX® SHO.....2010 & Newer  
 F225 Offshore.....2010 & Newer  
 250 HP.....1990 & Newer

250 HP VMAX® .....2001  
 F250 4-Stroke .....2002 & Newer  
 VF250 V MAX® SHO .....2010 & Newer  
 F250 Offshore.....2010 & Newer  
 300 HP .....2004-2007  
 F300 Offshore.....2010 & Newer



| 3-BLADE |      |       |          | 4-BLADE |      |       |          | STD. 3-BLADE |      |       |          | LG DIAMETER 3-BLADE |      |       |          | 4-BLADE |      |       |          |
|---------|------|-------|----------|---------|------|-------|----------|--------------|------|-------|----------|---------------------|------|-------|----------|---------|------|-------|----------|
| Dia.    | Rot. | Pitch | Part No. | Dia.    | Rot. | Pitch | Part No. | Dia.         | Rot. | Pitch | Part No. | Dia.                | Rot. | Pitch | Part No. | Dia.    | Rot. | Pitch | Part No. |
| 15-1/4  | R    | 15    | 992002   |         |      |       |          | 14-3/8       | R    | 15    | 993042   |                     |      |       |          |         |      |       |          |
|         |      |       |          |         |      |       |          | 14-3/8       | L    | 15    | 993052   |                     |      |       |          |         |      |       |          |
| 15      | R    | 17    | 992003   | 15      | R    | 16    | 992202   | 14-1/4       | R    | 17    | 993043   | 15-1/2              | R    | 17    | 993023   | 14-5/8  | R    | 16    | 993203   |
|         |      |       |          |         |      |       |          | 14-1/4       | L    | 17    | 993053   | 15-1/2              | L    | 17    | 993033   | 14-5/8  | L    | 16    | 993213   |
| 14-1/2  | R    | 19    | 992004   | 14-1/2  | R    | 18    | 992203   | 14-1/8       | R    | 19    | 993044   | 15-1/4              | R    | 19    | 993024   | 14-3/8  | R    | 18    | 993204   |
|         |      |       |          |         |      |       |          | 14-1/8       | L    | 19    | 993054   | 15-1/4              | L    | 19    | 993034   | 14-3/8  | L    | 18    | 993214   |
| 14-1/4  | R    | 21    | 992005   | 14      | R    | 20    | 992204   | 14           | R    | 21    | 993045   | 14-3/4              | R    | 21    | 993025   | 14-1/8  | R    | 20    | 993205   |
|         |      |       |          |         |      |       |          | 14           | L    | 21    | 993055   | 14-3/4              | L    | 21    | 993035   | 14-1/8  | L    | 20    | 993215   |
| 14      | R    | 23    | 992006   |         |      |       |          | 13-7/8       | R    | 23    | 993046   | 14-5/8              | R    | 23    | 993026   | 14      | R    | 22    | 993206   |
|         |      |       |          |         |      |       |          | 13-7/8       | L    | 23    | 993056   | 14-5/8              | L    | 23    | 993036   | 14      | L    | 22    | 993216   |

Drop-In Hub

Use XHS II® Hub Kit

**203**

Refer to Pages 40-41 for Details on Hub Kit Components.



| Boat Description/Length     | ALUMINUM PROPELLERS |      |       |      |                 |          | STAINLESS STEEL PROPELLERS |      |       |          |                      |      |       |          |
|-----------------------------|---------------------|------|-------|------|-----------------|----------|----------------------------|------|-------|----------|----------------------|------|-------|----------|
|                             | Dia.                | Rot. | Pitch | Bld# | OEM Part No.    | Part No. | 3-BLADE BALLISTIC          |      |       |          | 3-BLADE BALLISTIC XL |      |       |          |
|                             |                     |      |       |      |                 |          | Dia.                       | Rot. | Pitch | Part No. | Dia.                 | Rot. | Pitch | Part No. |
| 20'-22' - AL, SK <b>NEW</b> | 15-1/4              | R    | 15    | 3    | 6G5-45941-00-98 | 101025   | 14-7/8                     | R    | 15    | 345931   |                      |      |       |          |
| 19'-21' - AL, SK            | 14-1/2              | R    | 17    | 3    | 6G5-45947-01-98 | 101027   | 14-3/4                     | R    | 17    | 345932   |                      |      |       |          |
| 19'-21' - AL, SK            |                     |      |       |      |                 |          | 14-3/4                     | L    | 17    | 345962   |                      |      |       |          |
| 18'-20' - AL, SK            | 14                  | R    | 19    | 3    | 6G5-45945-01-98 | 101028   | 14-1/2                     | R    | 19    | 345933   |                      |      |       |          |
| 18'-20' - AL, SK            |                     |      |       |      |                 |          | 14-1/2                     | L    | 19    | 345963   |                      |      |       |          |
| 18'-20' - AL, SK <b>NEW</b> | 13-3/4              | R    | 21    | 3    | 6G5-45943-01-98 | 101029   | 14-3/8                     | R    | 21    | 345934   |                      |      |       |          |
| 18'-20' - AL, SK            |                     |      |       |      |                 |          | 14-3/8                     | L    | 21    | 345964   |                      |      |       |          |
| Up to 18' - AL, SK          |                     |      |       |      |                 |          | 14-1/4                     | R    | 23    | 345935   |                      |      |       |          |
| Up to 18' - AL, SK          |                     |      |       |      |                 |          | 14-1/4                     | L    | 23    | 345965   |                      |      |       |          |
| High Performance            |                     |      |       |      |                 |          |                            |      |       |          | 14-1/2               | R    | 22    | 345941   |
| High Performance            |                     |      |       |      |                 |          |                            |      |       |          | 14-1/2               | R    | 24    | 345937   |
| High Performance            |                     |      |       |      |                 |          |                            |      |       |          | 14-1/2               | R    | 26    | 345938   |
|                             |                     |      |       |      |                 |          |                            |      |       |          | 4-BLADE BALLISTIC XL |      |       |          |
| High Performance            |                     |      |       |      |                 |          |                            |      |       |          | 13-3/4               | R    | 23    | 435935   |
| High Performance            |                     |      |       |      |                 |          |                            |      |       |          | 13-3/4               | R    | 25    | 435936   |
| High Performance            |                     |      |       |      |                 |          |                            |      |       |          | 13-3/4               | R    | 27    | 435937   |

Rubber Hub Bushing

MERCUISER®, ALPHA ONE™, BRAVO ONE™ • 4-3/4" GEARCASE

Thru Hub Exhaust & 15 Tooth Spline

MODELS 1A, 1B, 1C  
 MODELS 120, 140, 145 DTS  
 MODELS 165, 228, 470, 485, 888, 898  
 MODELS 225S, 233, 255TRS  
 MODELS 260, 280TRS, 330TRS  
 120-190 HP Mercruiser® .....1983-1985  
 200-260 HP Mercruiser® .....1983-1985

**Alpha One™**  
 2.5L - 5.7L Alpha One™ .....All Years  
 6.2L MPI Alpha One™ .....All Years  
 262, 350, 354 Magnum .....All Years  
 320 EFI Alpha One™ .....All Years  
 D2.8L - D7.3L (Diesel) .....All Years

**Bravo One™** (Bravo One™ & Bravo One™ X Drives only)  
 320 EFI, 350, 377 .....All Years  
 5.0L - 7.4L Bravo One™ .....All Years



| 3-BLADE |      |       |          | 4-BLADE |      |       |          | STD. 3-BLADE |      |       |          | LG DIAMETER 3-BLADE |      |       |          | 4-BLADE |      |       |          |
|---------|------|-------|----------|---------|------|-------|----------|--------------|------|-------|----------|---------------------|------|-------|----------|---------|------|-------|----------|
| Dia.    | Rot. | Pitch | Part No. | Dia.    | Rot. | Pitch | Part No. | Dia.         | Rot. | Pitch | Part No. | Dia.                | Rot. | Pitch | Part No. | Dia.    | Rot. | Pitch | Part No. |
| 15-1/4  | R    | 15    | 992002   |         |      |       |          | 14-3/8       | R    | 15    | * 993042 |                     |      |       |          |         |      |       |          |
|         |      |       |          |         |      |       |          | 14-3/8       | L    | 15    | * 993052 |                     |      |       |          |         |      |       |          |
| 15      | R    | 17    | 992003   | 15      | R    | 16    | 992202   | 14-1/4       | R    | 17    | * 993043 | 15-1/2              | R    | 17    | ∅ 993023 | 14-5/8  | R    | 16    | * 993203 |
|         |      |       |          |         |      |       |          | 14-1/4       | L    | 17    | * 993053 | 15-1/2              | L    | 17    | ∅ 993033 | 14-5/8  | L    | 16    | * 993213 |
| 14-1/2  | R    | 19    | 992004   | 14-1/2  | R    | 18    | 992203   | 14-1/8       | R    | 19    | * 993044 | 15-1/4              | R    | 19    | ∅ 993024 | 14-3/8  | R    | 18    | * 993204 |
|         |      |       |          |         |      |       |          | 14-1/8       | L    | 19    | * 993054 | 15-1/4              | L    | 19    | ∅ 993034 | 14-3/8  | L    | 18    | * 993214 |
| 14-1/4  | R    | 21    | 992005   | 14      | R    | 20    | * 992204 | 14           | R    | 21    | ∅ 993045 | 14-3/4              | R    | 21    | ∅ 993025 | 14-1/8  | R    | 20    | * 993205 |
|         |      |       |          |         |      |       |          | 14           | L    | 21    | ∅ 993055 | 14-3/4              | L    | 21    | ∅ 993035 | 14-1/8  | L    | 20    | * 993215 |
| 14      | R    | 23    | 992006   |         |      |       |          | 13-7/8       | R    | 23    | ∅ 993046 | 14-5/8              | R    | 23    | ∅ 993026 | 14      | R    | 22    | * 993206 |
|         |      |       |          |         |      |       |          | 13-7/8       | L    | 23    | ∅ 993056 | 14-5/8              | L    | 23    | ∅ 993036 | 14      | L    | 22    | * 993216 |

Drop-In Hub

Use XHS II®  
Hub Kit

202

Refer to Pages 40-41  
for Details on Hub Kit  
Components.



| Boat Description/Length | ALUMINUM PROPELLERS    |        |       |      |              |              | STAINLESS STEEL PROPELLERS |      |       |          |                      |      |       |          |  |        |   |    |          |
|-------------------------|------------------------|--------|-------|------|--------------|--------------|----------------------------|------|-------|----------|----------------------|------|-------|----------|--|--------|---|----|----------|
|                         | Dia.                   | Rot.   | Pitch | Bld# | OEM Part No. | Part No.     | 3-BLADE BALLISTIC          |      |       |          | 3-BLADE BALLISTIC XL |      |       |          |  |        |   |    |          |
|                         |                        |        |       |      |              |              | Dia.                       | Rot. | Pitch | Part No. | Dia.                 | Rot. | Pitch | Part No. |  |        |   |    |          |
| CR, HB                  | 16                     | R      | 13    | 3    | 48-78114A45  | 031022       |                            |      |       |          |                      |      |       |          |  |        |   |    |          |
| 22'-25' - AL            | 16                     | R      | 14    | 3    | 48-16438A45  | 031050       |                            |      |       |          |                      |      |       |          |  |        |   |    |          |
| 21'-24' - AL            | 15-1/4                 | R      | 15    | 3    | 48-78116A45  | 031023       | 14-7/8                     | R    | 15    | * 345131 |                      |      |       |          |  |        |   |    |          |
| 20'-23' - AL, SK        | 16                     | R      | 16    | 3    | 48-16440A45  | 031051       |                            |      |       |          |                      |      |       |          |  |        |   |    |          |
| 19'-23' - AL, SK        | 14-1/2                 | R      | 17    | 3    | 48-78118A40  | 031024       | 14-3/4                     | R    | 17    | * 345132 |                      |      |       |          |  |        |   |    |          |
| 19'-23' - AL, SK        | 15                     | R      | 17    | 3    | 48-832828A45 | 031064       | 14-3/4                     | L    | 17    | * 345162 |                      |      |       |          |  |        |   |    |          |
| 19'-22' - AL, SK        | 15-1/2                 | R      | 18    | 3    | 48-11324A45  | 031052       |                            |      |       |          |                      |      |       |          |  |        |   |    |          |
| 18'-22' - AL, SK        | 14                     | R      | 19    | 3    | 48-78120A40  | 031025       | 14-1/2                     | R    | 19    | * 345133 |                      |      |       |          |  |        |   |    |          |
| 18'-22' - AL, SK        | 14-1/2                 | R      | 19    | 3    | 48-832830A45 | 031065       | 14-1/2                     | L    | 19    | * 345163 |                      |      |       |          |  |        |   |    |          |
| 18'-20' - AL, SK        | 13-3/4                 | R      | 21    | 3    | 48-78122A40  | 031026       | 14-3/8                     | R    | 21    | * 345134 |                      |      |       |          |  |        |   |    |          |
| 18'-20' - AL, SK        | 14-1/4                 | R      | 21    | 3    | 48-832832A45 | 031066       | 14-3/8                     | L    | 21    | * 345164 |                      |      |       |          |  |        |   |    |          |
| 17'-20' - AL, SK        |                        |        |       |      |              |              | 14-1/4                     | R    | 23    | * 345135 |                      |      |       |          |  |        |   |    |          |
| 17'-20' - AL, SK        |                        |        |       |      |              |              | 14-1/4                     | L    | 23    | * 345165 |                      |      |       |          |  |        |   |    |          |
| Up to 18'               |                        |        |       |      |              |              | 14-1/4                     | R    | 25    | * 345136 |                      |      |       |          |  |        |   |    |          |
| High Performance        |                        |        |       |      |              |              |                            |      |       |          |                      |      |       |          |  | 14-1/2 | R | 22 | * 345141 |
| High Performance        |                        |        |       |      |              |              |                            |      |       |          |                      |      |       |          |  | 14-1/2 | R | 24 | * 345137 |
| High Perf. (EFI Engine) |                        |        |       |      |              |              |                            |      |       |          |                      |      |       |          |  | 14     | R | 24 | * 345139 |
| High Performance        |                        |        |       |      |              |              |                            |      |       |          |                      |      |       |          |  | 14-1/2 | R | 26 | * 345138 |
| High Perf. (EFI Engine) |                        |        |       |      |              |              |                            |      |       |          |                      |      |       |          |  | 14     | R | 26 | * 345140 |
|                         | 4-BLADE MICHIGAN MATCH |        |       |      |              |              |                            |      |       |          |                      |      |       |          |  |        |   |    |          |
| 21'-24' - AL, SK        | NEW                    | 15     | R     | 16   | 4            | 48-834850A45 | 031080                     |      |       |          |                      |      |       |          |  |        |   |    |          |
| 19'-23' - AL, SK        | NEW                    | 14-1/2 | R     | 18   | 4            | 48-834852A45 | 031082                     |      |       |          |                      |      |       |          |  |        |   |    |          |
| 18'-20' - AL, SK        | NEW                    | 14     | R     | 20   | 4            | 48-834854A45 | 031084                     |      |       |          |                      |      |       |          |  |        |   |    |          |

Rubber  
Hub  
Bushing

Use OEM  
Fwd Washer 12-835467  
Aft Washer 12-31211A3  
Tab Washer 14-816629

or  
MWM Kit 990312  
(Conductivity Washer,  
Aft Washer)

or  
MWM Kit 9661-1  
(Fwd Washer,  
Conductivity Washer,  
Aft Washer, Tab Washer,  
Propeller Nut)

See Page 24 for details.

Key to Abbreviations: LL = Light Loads; SB = Sailboat; AL = All Loads; SK = Skiboat; WB = Workboat; HB = Houseboat; CR = Cruisers; HL = Heavy Loads; WD = Weedless

∅ These applications will require an anode plate 76214Q5 (Quicksilver® Part Number) in place of the 822777A1 trim tab.  
 \* When using Ballistic® and Apollo® propellers, to avoid damage or injury, replace standard trim tab with trim tab 822777A1.



**BRAVO ONE™ • OVER 365 HP • (SOLID HUB) • 4-3/4" GEARCASE**

Thru Hub Exhaust & 15 Tooth Spline

454 Magnum (385 HP) .....1995 & Newer  
 496 Magnum (375 HP) .....All Years  
 496 Magnum H.O. (425 HP).....All Years

502 Magnum (390-415 HP) .....1990 & Newer  
 450 HP .....1995  
 465 HP .....1991 & 1994

500 HP .....1996 & Newer  
 525 HP (SC) (490-200).....1992 & Newer



Apoello® XHS®  
Stainless Steel Propeller



| APOLLO       |      |       |          |                     |      |       |          |         |      |       |          |
|--------------|------|-------|----------|---------------------|------|-------|----------|---------|------|-------|----------|
| STD. 3-BLADE |      |       |          | LG DIAMETER 3-BLADE |      |       |          | 4-BLADE |      |       |          |
| Dia.         | Rot. | Pitch | Part No. | Dia.                | Rot. | Pitch | Part No. | Dia.    | Rot. | Pitch | Part No. |
| 14-3/8       | R    | 15    | * 993042 |                     |      |       |          |         |      |       |          |
| 14-3/8       | L    | 15    | * 993052 |                     |      |       |          |         |      |       |          |
| 14-1/4       | R    | 17    | * 993043 | 15-1/2              | R    | 17    | ∅ 993023 | 14-5/8  | R    | 16    | * 993203 |
| 14-1/4       | L    | 17    | * 993053 | 15-1/2              | L    | 17    | ∅ 993033 | 14-5/8  | L    | 16    | * 993213 |
| 14-1/8       | R    | 19    | * 993044 | 15-1/4              | R    | 19    | ∅ 993024 | 14-3/8  | R    | 18    | * 993204 |
| 14-1/8       | L    | 19    | * 993054 | 15-1/4              | L    | 19    | ∅ 993034 | 14-3/8  | L    | 18    | * 993214 |
| 14           | R    | 21    | ∅ 993045 | 14-3/4              | R    | 21    | ∅ 993025 | 14-1/8  | R    | 20    | * 993205 |
| 14           | L    | 21    | ∅ 993055 | 14-3/4              | L    | 21    | ∅ 993035 | 14-1/8  | L    | 20    | * 993215 |
| 13-7/8       | R    | 23    | ∅ 993046 | 14-5/8              | R    | 23    | ∅ 993026 | 14      | R    | 22    | * 993206 |
| 13-7/8       | L    | 23    | ∅ 993056 | 14-5/8              | L    | 23    | ∅ 993036 | 14      | L    | 22    | * 993216 |

Drop-In Hub

Use XHS II®  
Hub Kit

**202SH**

Refer to Pages 40-41  
for Details on Hub Kit  
Components.







Key to Abbreviations: LL = Light Loads; SB = Sailboat; AL = All Loads; SK = Skiboat; WB = Workboat; HB = Houseboat; CR = Cruisers; HL = Heavy Loads; WD = Weedless

∅ These applications will require an anode plate 76214Q5 (Quicksilver® Part Number) in place of the 822777A1 trim tab.  
 \* When using Ballistic® and Apoello® propellers, to avoid damage or injury, replace standard trim tab with trim tab 822777A1.

**MODEL 400, COBRA® • 4-1/4" GEARCASE**

Thru Hub Exhaust & 13 Tooth Spline



|                                |                                |
|--------------------------------|--------------------------------|
| Model 400                      | Cobra®                         |
| 2.3 L (120 HP) ..... Thru 1991 | 2.3 L (128 HP) ..... 1988-1991 |
| 2.5 L (120 HP) ..... 1978-1984 | 2.5 L (120 HP) ..... 1985-1987 |
| 3.0 L (140 HP) ..... Thru 1989 | 3.0 L (140 HP) ..... 1985-1987 |

| Boat Description/Length |  |      |       |      |              |          |  |      |       |      |              |          | Drop-In Hub<br>Use XHS II® Hub Kit<br><b>206</b><br>Do NOT use Gearcase Adapter Ring supplied with propeller.<br>Refer to Pages 40-41 for Details on Hub Kit Components. |
|-------------------------|---|------|-------|------|--------------|----------|---|------|-------|------|--------------|----------|--|
|                         | ALUMINUM PROPELLERS   |      |       |      |              |          | STAINLESS STEEL PROPELLERS  |      |       |      |              |          |  |
|                         | Dia.  | Rot. | Pitch | Bld# | OEM Part No. | Part No. | Dia.  | Rot. | Pitch | Bld# | OEM Part No. | Part No. |  |
|                         | 14  | R    | 10    | 3    |              | 992109   |   |      |       |      |              |          |  |
|                         | 14  | R    | 13    | 3    | 765181       | 992112   |   |      |       |      |              |          |  |
| 19'-22' (24-37 MPH)     | 13-3/4  | R    | 15    | 3    | 765182       | 992113   | 13-3/8  | R    | 15    | 3    |              | 993143   |  |
| 19'-22' (24-37 MPH)     |   |      |       |      |              |          | 13-3/8  | L    | 15    | 3    |              | 993153   |  |
| 17'-20' (30-45 MPH)     | 13-1/4  | R    | 17    | 3    | 765183       | 992114   | 13-1/4  | R    | 17    | 3    |              | 993144   |  |
| 17'-20' (30-45 MPH)     |   |      |       |      |              |          | 13-1/4  | L    | 17    | 3    |              | 993154   |  |
| 16'-19' (36-50 MPH)     | 13  | R    | 19    | 3    | 765184       | 992115   | 13-1/8  | R    | 19    | 3    |              | 993145   |  |
| 16'-19' (36-50 MPH)     |   |      |       |      |              |          | 13-1/8  | L    | 19    | 3    |              | 993155   |  |
| 15'-18' (41-53 MPH)     | 12-3/4  | R    | 21    | 3    | 765185       | 992116   | 13  | R    | 21    | 3    |              | 993146   |  |
| 15'-18' (41-53 MPH)     |   |      |       |      |              |          | 13  | L    | 21    | 3    |              | 993156   |  |
| Boat Description/Length |  |      |       |      |              |          |  |      |       |      |              |          | Rubber Hub Bushing   |
|                         | ALUMINUM PROPELLERS   |      |       |      |              |          | STAINLESS STEEL PROPELLERS  |      |       |      |              |          |  |
|                         | Dia.  | Rot. | Pitch | Bld# | OEM Part No. | Part No. | Dia.  | Rot. | Pitch | Bld# | OEM Part No. | Part No. |  |
| WB (6-16 MPH)           | 14  | R    | 11    | 3    | 763301       | 012047   |   |      |       |      |              |          |  |
| CR, HB (14-26 MPH)      | 14  | R    | 13    | 3    | 763302       | 011001   |   |      |       |      |              |          |  |
| 19'-22' (24-37 MPH)     | 13-3/4  | R    | 15    | 3    | 763466       | 011002   | 13-5/8  | R    | 15    | 3    |              | 335030   |  |
| 17'-20' (30-45 MPH)     | 13-1/4  | R    | 17    | 3    | 763463       | 011003   | 13-1/2  | R    | 17    | 3    |              | 335031   |  |
| 17'-20' (30-45 MPH)     | 14  | R    | 17    | 3    | 763463       | 011024   |   |      |       |      |              |          |  |
| 16'-19' (36-50 MPH)     | 13  | R    | 19    | 3    | 763464       | 011004   | 13-3/8  | R    | 19    | 3    |              | 335032   |  |
| 16'-19' (36-50 MPH)     | 14  | R    | 19    | 3    | 763464       | 011025   |   |      |       |      |              |          |  |
| 15'-18' (41-53 MPH)     | 12-3/4  | R    | 21    | 3    | 763465       | 011005   | 13-1/8  | R    | 21    | 3    |              | 335033   |  |

**SEA DRIVE® 1982 & NEWER • 4-1/4" GEARCASE**

Thru Hub Exhaust & 13 Tooth Spline

|   |                              |
|---|------------------------------|
| 1.6 L V-4 ..... 1982 & Newer              | 1.8 L V-4 ..... 1987 & Newer |
| For twin installations increase pitch 2". |                              |

| Boat Description/Length |  |      |       |      |              |          |  |      |       |      |              |          | Rubber Hub Bushing |
|-------------------------|---|------|-------|------|--------------|----------|---|------|-------|------|--------------|----------|--------------------|
|                         | ALUMINUM PROPELLERS   |      |       |      |              |          | STAINLESS STEEL PROPELLERS  |      |       |      |              |          |                    |
|                         | Dia.  | Rot. | Pitch | Bld# | OEM Part No. | Part No. | Dia.  | Rot. | Pitch | Bld# | OEM Part No. | Part No. |                    |
| Barges, HB (1-18 MPH)   | 14  | R    | 11    | 3    | 763301       | 012047   |   |      |       |      |              |          |                    |
| 26' & Up (14-28 MPH)    | 14  | R    | 13    | 3    | 763302       | 011001   |   |      |       |      |              |          |                    |
| 22'-26' (24-36 MPH)     | 13-3/4  | R    | 15    | 3    | 763466       | 011002   | 13-5/8  | R    | 15    | 3    |              | 335030   |                    |
| 19'-22' (30-40 MPH)     | 13-1/4  | R    | 17    | 3    | 763463       | 011003   | 13-1/2  | R    | 17    | 3    |              | 335031   |                    |
| 19'-22' (30-40 MPH)     | 14  | R    | 17    | 3    | 763463       | 011024   |   |      |       |      |              |          |                    |
| 17'-20' (38-50 MPH)     | 13  | R    | 19    | 3    | 763464       | 011004   | 13-3/8  | R    | 19    | 3    |              | 335032   |                    |
| 17'-20' (38-50 MPH)     | 14  | R    | 19    | 3    | 763464       | 011025   |   |      |       |      |              |          |                    |
| 15'-18' (44-56 MPH)     | 12-3/4  | R    | 21    | 3    | 763465       | 011005   | 13-1/8  | R    | 21    | 3    |              | 335033   |                    |

**MODEL 800, KING COBRA®, COBRA®, SEA DRIVE® • 4-3/4" GEARCASE**

Thru Hub Exhaust & 15 Tooth Spline

3.0 L - 8.2 L (Non SX Drive) .....1990-1993  
Includes H.O. and EFI Models

5.8 L (Cobra®) ..... 1989-1993

Sea Drive® 2.0 L - 4.0 L .....All Years

**Note: For SX Drive, see Volvo Penta section on Page 39.**

| 3-BLADE |      | 4-BLADE |          | STD. 3-BLADE |      | LG DIAMETER 3-BLADE |          | 4-BLADE |      |       |          |        |      |       |          |        |      |       |          |  |
|---------|------|---------|----------|--------------|------|---------------------|----------|---------|------|-------|----------|--------|------|-------|----------|--------|------|-------|----------|--|
| Dia.    | Rot. | Pitch   | Part No. | Dia.         | Rot. | Pitch               | Part No. | Dia.    | Rot. | Pitch | Part No. | Dia.   | Rot. | Pitch | Part No. | Dia.   | Rot. | Pitch | Part No. |  |
| 15-1/4  | R    | 15      | 992002   |              |      |                     |          | 14-3/8  | R    | 15    | 993042   |        |      |       |          |        |      |       |          |  |
|         |      |         |          |              |      |                     |          | 14-3/8  | L    | 15    | 993052   |        |      |       |          |        |      |       |          |  |
| 15      | R    | 17      | 992003   | 15           | R    | 16                  | 992202   | 14-1/4  | R    | 17    | 993043   | 15-1/2 | R    | 17    | 993023   | 14-5/8 | R    | 16    | 993203   |  |
|         |      |         |          |              |      |                     |          | 14-1/4  | L    | 17    | 993053   | 15-1/2 | L    | 17    | 993033   | 14-5/8 | L    | 16    | 993213   |  |
| 14-1/2  | R    | 19      | 992004   | 14-1/2       | R    | 18                  | 992203   | 14-1/8  | R    | 19    | 993044   | 15-1/4 | R    | 19    | 993024   | 14-3/8 | R    | 18    | 993204   |  |
|         |      |         |          |              |      |                     |          | 14-1/8  | L    | 19    | 993054   | 15-1/4 | L    | 19    | 993034   | 14-3/8 | L    | 18    | 993214   |  |
| 14-1/4  | R    | 21      | 992005   | 14           | R    | 20                  | 992204   | 14      | R    | 21    | 993045   | 14-3/4 | R    | 21    | 993025   | 14-1/8 | R    | 20    | 993205   |  |
|         |      |         |          |              |      |                     |          | 14      | L    | 21    | 993055   | 14-3/4 | L    | 21    | 993035   | 14-1/8 | L    | 20    | 993215   |  |
| 14      | R    | 23      | 992006   |              |      |                     |          | 13-7/8  | R    | 23    | 993046   | 14-5/8 | R    | 23    | 993026   | 14     | R    | 22    | 993206   |  |
|         |      |         |          |              |      |                     |          | 13-7/8  | L    | 23    | 993056   | 14-5/8 | L    | 23    | 993036   | 14     | L    | 22    | 993216   |  |

Drop-In Hub

Use XHS II® Hub Kit

**200 / 201**

Refer to Pages 40-41 for Details on Hub Kit Components.

Note: For engine applications 1978-1990 use XHS II® (Drop-In Hub) Kit #201.  
For engine applications 1991 & Newer use XHS II® (Drop-In Hub) Kit #200.

| Boat Description/Length |                     |      |       |      |              |          |                            |      |       |      |              |          |
|-------------------------|---------------------|------|-------|------|--------------|----------|----------------------------|------|-------|------|--------------|----------|
|                         | ALUMINUM PROPELLERS |      |       |      |              |          | STAINLESS STEEL PROPELLERS |      |       |      |              |          |
|                         | Dia.                | Rot. | Pitch | Bld# | OEM Part No. | Part No. | Dia.                       | Rot. | Pitch | Bld# | OEM Part No. | Part No. |
| Non-Plane Heavy CR      | 15-1/2              | R    | 13    | 3    | 391536       | 011016   |                            |      |       |      |              |          |
| 22'-28' (22-32 MPH)     | 15-1/2              | R    | 15    | 3    | 391535       | 011006   |                            |      |       |      |              |          |
| 19'-26' (28-39 MPH)     |                     |      |       |      |              |          | 14-7/8                     | R    | 15    | 3    |              | 345031   |
| 18'-26' (30-46 MPH)     | 15                  | R    | 17    | 3    | 391200       | 011007   | 14-3/4                     | R    | 17    | 3    |              | 345032   |
| 18'-26' (30-46 MPH)     |                     |      |       |      |              |          | 14-3/4                     | L    | 17    | 3    |              | 345062   |
| 17'-24' (36-52 MPH)     | 14-1/2              | R    | 19    | 3    | 391201       | 011008   | 14-1/2                     | R    | 19    | 3    |              | 345033   |
| 17'-24' (36-52 MPH)     |                     |      |       |      |              |          | 14-1/2                     | R    | 19    | 3    |              | 345063   |
| 16'-22' (40-60 MPH)     | 14-1/4              | R    | 21    | 3    | 391202       | 011009   | 14-3/8                     | R    | 21    | 3    |              | 345034   |
| 16'-22' (40-60 MPH)     |                     |      |       |      |              |          | 14-3/8                     | L    | 21    | 3    |              | 345064   |
| 15'-20' (45-66 MPH)     | 14-1/4              | R    | 23    | 3    | 391203       | ⊗ 011010 | 14-1/4                     | R    | 23    | 3    |              | 345035   |
| 15'-20' (45-66 MPH)     |                     |      |       |      |              |          | 14-1/4                     | L    | 23    | 3    |              | 345065   |
| High Perf. (50-66 MPH)  |                     |      |       |      |              |          | 14-1/4                     | R    | 25    | 3    |              | 345036   |

Rubber Hub Bushing

**MODEL 14 LARGE GEARCASE 1967-1977**

Non-Thru Hub Exhaust & Pin Drive

Suggestion: For twin installation increase pitch 2".  
HP Range: 120-245

| Boat Description/Length |                     |      |       |      |              |          |
|-------------------------|---------------------|------|-------|------|--------------|----------|
|                         | ALUMINUM PROPELLERS |      |       |      |              |          |
|                         | Dia.                | Rot. | Pitch | Bld# | OEM Part No. | Part No. |
| HP Range: 120-245       | 14                  | R    | 14    | 3    | 381185       | 012091   |
|                         | 14                  | R    | 16    | 3    | 381186       | 012092   |



Rubber Hub Bushing

Key to Abbreviations: LL = Light Loads; SB = Sailboat; AL = All Loads; SK = Skiboat; WB = Workboat; HB = Houseboat; CR = Cruisers; HL = Heavy Loads; WD = Weedless

⊗ Limited Inventory Item.

## SX COBRA™, VOLVO PENTA SX • 4-3/4" GEARCASE

Thru Hub Exhaust & 19 Tooth Spline

|                        |                        |                        |
|------------------------|------------------------|------------------------|
| 3.0 L.....1994 & Newer | 5.7 L.....1994 & Newer | 7.4 L.....1997 & Newer |
| 4.3 L.....1994 & Newer | 5.8 L.....1994-1997    | 8.2 L.....1997         |
| 5.0 L.....1994 & Newer |                        |                        |



| 3-BLADE |      |       |          | 4-BLADE |      |       |          | STD. 3-BLADE |      |       |          | LG DIAMETER 3-BLADE |      |       |          | 4-BLADE |      |       |          |
|---------|------|-------|----------|---------|------|-------|----------|--------------|------|-------|----------|---------------------|------|-------|----------|---------|------|-------|----------|
| Dia.    | Rot. | Pitch | Part No. | Dia.    | Rot. | Pitch | Part No. | Dia.         | Rot. | Pitch | Part No. | Dia.                | Rot. | Pitch | Part No. | Dia.    | Rot. | Pitch | Part No. |
| 15-1/4  | R    | 15    | 992002   |         |      |       |          | 14-3/8       | R    | 15    | 993042   |                     |      |       |          |         |      |       |          |
|         |      |       |          |         |      |       |          | 14-3/8       | L    | 15    | 993052   |                     |      |       |          |         |      |       |          |
| 15      | R    | 17    | 992003   | 15      | R    | 16    | 992202   | 14-1/4       | R    | 17    | 993043   | 15-1/2              | R    | 17    | 993023   | 14-5/8  | R    | 16    | 993203   |
|         |      |       |          |         |      |       |          | 14-1/4       | L    | 17    | 993053   | 15-1/2              | L    | 17    | 993033   | 14-5/8  | L    | 16    | 993213   |
| 14-1/2  | R    | 19    | 992004   | 14-1/2  | R    | 18    | 992203   | 14-1/8       | R    | 19    | 993044   | 15-1/4              | R    | 19    | 993024   | 14-3/8  | R    | 18    | 993204   |
|         |      |       |          |         |      |       |          | 14-1/8       | L    | 19    | 993054   | 15-1/4              | L    | 19    | 993034   | 14-3/8  | L    | 18    | 993214   |
| 14-1/4  | R    | 21    | 992005   | 14      | R    | 20    | 992204   | 14           | R    | 21    | 993045   | 14-3/4              | R    | 21    | 993025   | 14-1/8  | R    | 20    | 993205   |
|         |      |       |          |         |      |       |          | 14           | L    | 21    | 993055   | 14-3/4              | L    | 21    | 993035   | 14-1/8  | L    | 20    | 993215   |
| 14      | R    | 23    | 992006   |         |      |       |          | 13-7/8       | R    | 23    | 993046   | 14-5/8              | R    | 23    | 993026   | 14      | R    | 22    | 993206   |
|         |      |       |          |         |      |       |          | 13-7/8       | L    | 23    | 993056   | 14-5/8              | L    | 23    | 993036   | 14      | L    | 22    | 993216   |

Drop-In Hub

Use XHS II® Hub Kit

**205**

Refer to Pages 40-41 for Details on Hub Kit Components.



| Boat Description/Length | ALUMINUM PROPELLERS |      |       |      |              |          | STAINLESS STEEL PROPELLERS |      |       |      |              |          |
|-------------------------|---------------------|------|-------|------|--------------|----------|----------------------------|------|-------|------|--------------|----------|
|                         | Dia.                | Rot. | Pitch | Bld# | OEM Part No. | Part No. | Dia.                       | Rot. | Pitch | Bld# | OEM Part No. | Part No. |
| 24'-25' (26-36 MPH)     | 15-1/2              | R    | 15    | 3    | 3850299      | 161001   | 14-7/8                     | R    | 15    | 3    |              | 346031   |
| 22'-27' (34-44 MPH)     | 15                  | R    | 17    | 3    | 3850300      | 161002   | 14-3/4                     | R    | 17    | 3    |              | 346032   |
| 22'-27' (33-44 MPH)     |                     |      |       |      |              |          | 14-3/4                     | L    | 17    | 3    |              | 346062   |
| 19'-25' (39-50 MPH)     | 14-1/2              | R    | 19    | 3    | 3850301      | 161003   | 14-1/2                     | R    | 19    | 3    |              | 346033   |
| 19'-25' (39-50 MPH)     |                     |      |       |      |              |          | 14-1/2                     | L    | 19    | 3    |              | 346063   |
| 17'-22' (39-50 MPH)     | 14-1/4              | R    | 21    | 3    | 3850302      | 161004   | 14-3/8                     | R    | 21    | 3    |              | 346034   |
| 17'-22' (39-50 MPH)     |                     |      |       |      |              |          | 14-3/8                     | L    | 21    | 3    |              | 346064   |
| 17'-20' (44-57 MPH)     | 14-1/4              | R    | 23    | 3    | 3850303      | 161005   | 14-1/4                     | R    | 23    | 3    |              | 346035   |
| 17'-20' (44-57 MPH)     |                     |      |       |      |              |          | 14-1/4                     | L    | 23    | 3    |              | 346065   |

Rubber Hub Bushing

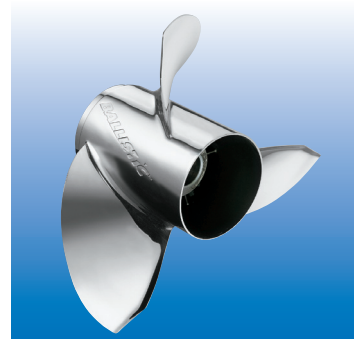

Key to Abbreviations: LL = Light Loads; SB = Sailboat; AL = All Loads; SK = Skiboat; WB = Workboat; HB = Houseboat; CR = Cruisers; HL = Heavy Loads; WD = Weedless

**YAMAHA STERNDRIVES • 4-3/4" GEARCASE**



Thru Hub Exhaust & 15 Tooth Spline

3.0 L (130 HP) EST/PSR .....1989-1993  
 4.3 L (205 HP) EST/PSR/YEMS .....1989-1993



5.0 L (205 HP) EST/PSR/YEMS ..... 1989-1993  
 5.7 L (260 HP) EST/PSR/YEMS ..... 1989-1993

7.4 L (300 HP\*) Hydra Drive EST1992-1993

\* For engines 300 HP or higher, use "high horsepower sleeve". See pages 41-42 for more details.

|  |      |       |          |  |      |       |          |              |      |       |          |                     |      |       |          |         |      |       |          |
|---|------|-------|----------|--|------|-------|----------|--------------|------|-------|----------|---------------------|------|-------|----------|---------|------|-------|----------|
| 3-BLADE   |      |       |          | 4-BLADE  |      |       |          | STD. 3-BLADE |      |       |          | LG DIAMETER 3-BLADE |      |       |          | 4-BLADE |      |       |          |
| Dia.  | Rot. | Pitch | Part No. | Dia.   | Rot. | Pitch | Part No. | Dia.         | Rot. | Pitch | Part No. | Dia.                | Rot. | Pitch | Part No. | Dia.    | Rot. | Pitch | Part No. |
| 15-1/4  | R    | 15    | 992002   |  |      |       |          | 14-3/8       | R    | 15    | 993042   |                     |      |       |          |         |      |       |          |
|   |      |       |          |  |      |       |          | 14-3/8       | L    | 15    | 993052   |                     |      |       |          |         |      |       |          |
| 15  | R    | 17    | 992003   | 15   | R    | 16    | 992202   | 14-1/4       | R    | 17    | 993043   | 15-1/2              | R    | 17    | 993023   | 14-5/8  | R    | 16    | 993203   |
|   |      |       |          |  |      |       |          | 14-1/4       | L    | 17    | 993053   | 15-1/2              | L    | 17    | 993033   | 14-5/8  | L    | 16    | 993213   |
| 14-1/2  | R    | 19    | 992004   | 14-1/2   | R    | 18    | 992203   | 14-1/8       | R    | 19    | 993044   | 15-1/4              | R    | 19    | 993024   | 14-3/8  | R    | 18    | 993204   |
|   |      |       |          |  |      |       |          | 14-1/8       | L    | 19    | 993054   | 15-1/4              | L    | 19    | 993034   | 14-3/8  | L    | 18    | 993214   |
| 14-1/4  | R    | 21    | 992005   | 14   | R    | 20    | 992204   | 14           | R    | 21    | 993045   | 14-3/4              | R    | 21    | 993025   | 14-1/8  | R    | 20    | 993205   |
|   |      |       |          |  |      |       |          | 14           | L    | 21    | 993055   | 14-3/4              | L    | 21    | 993035   | 14-1/8  | L    | 20    | 993215   |
| 14  | R    | 23    | 992006   |  |      |       |          | 13-7/8       | R    | 23    | 993046   | 14-5/8              | R    | 23    | 993026   | 14      | R    | 22    | 993206   |
|   |      |       |          |  |      |       |          | 13-7/8       | L    | 23    | 993056   | 14-5/8              | L    | 23    | 993036   | 14      | L    | 22    | 993216   |

| Boat Description/Length |  |      |       |      |                 |          |  |      |       |      |              |          |
|-------------------------|---|------|-------|------|-----------------|----------|---|------|-------|------|--------------|----------|
|                         | ALUMINUM PROPELLERS   |      |       |      |                 |          | STAINLESS STEEL PROPELLERS  |      |       |      |              |          |
|                         | Dia.  | Rot. | Pitch | Bld# | OEM Part No.    | Part No. | Dia.  | Rot. | Pitch | Bld# | OEM Part No. | Part No. |
| 21'-26' (18-31 MPH)     |   |      |       |      |                 |          | 14-7/8  | R    | 15    | 3    |              | 345931   |
| 19'-23' (27-37 MPH)     | 14-1/2  | R    | 17    | 3    | 6G5-45947-01-98 | 101027   | 14-3/4  | R    | 17    | 3    |              | 345932   |
| 19'-23' (27-37 MPH)     |   |      |       |      |                 |          | 14-3/4  | L    | 17    | 3    |              | 345962   |
| 17'-21' (33-42 MPH)     | 14  | R    | 19    | 3    | 6G5-45945-01-98 | 101028   | 14-1/2  | R    | 19    | 3    |              | 345933   |
| 17'-21' (33-42 MPH)     |   |      |       |      |                 |          | 14-1/2  | L    | 19    | 3    |              | 345963   |
| 18'-19' (37-46 MPH)     |   |      |       |      |                 |          | 14-3/8  | R    | 21    | 3    |              | 345934   |
| 18'-19' (37-46 MPH)     |   |      |       |      |                 |          | 14-3/8  | L    | 21    | 3    |              | 345964   |
| 17'-19' (39-48 MPH)     |   |      |       |      |                 |          | 14-1/4  | R    | 23    | 3    |              | 345935   |
| 17'-19' (39-48 MPH)     |   |      |       |      |                 |          | 14-1/4  | L    | 23    | 3    |              | 345965   |

Drop-In Hub

Use XHS II® Hub Kit

**203**

Refer to Pages 40-41 for Details on Hub Kit Components.

Rubber Hub Bushing



# XHS® / XHS II® PROPELLER ACCESSORIES

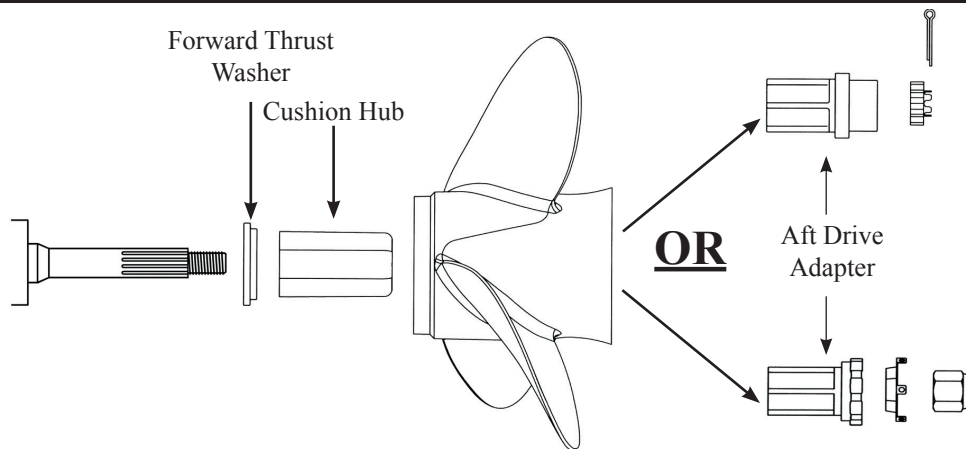

| Hub Kit | Description   | Part Number / Description                 |
|---------|---|---|
| 200     | Evinrude®/Johnson® Outboards - OMC® Sterndrive<br>(V6/V8 Gearcase • 1991 to Present)  | 991202 Forward Thrust Washer              |
|         |   | 991203 Aft Drive Adapter                  |
|         |   | 991301 Cushion Hub                        |
| 201     | Evinrude®/Johnson® Outboards - OMC® Sterndrive<br>(V6/V8 Gearcase • 1984-1990)  | 991204 Forward Thrust Washer              |
|         |   | 991203 Aft Drive Adapter                  |
|         |   | 991301 Cushion Hub                        |
| 202     | Mercruiser® Alpha One® & Bravo One® (Less than 400 HP)<br>Mercury®/Mariner®/Sea Ray 40-140 HP<br>Mercury®/Mariner®/Sea ray 135-300 HP<br>Force® 85-150 HP (Dual Exhaust Units)<br>Force® 75-150 HP (Mercury® 4-1/4" Gearcase)<br>Honda® Outboards 70-90 HP (Thru 1998)<br>Yamaha® Outboards 80-175 HP (Thru 1983) | 991204 Forward Thrust Washer              |
|         |   | 990344 Tab Washer                         |
|         |   | 991205 Aft Drive Adapter                  |
|         |   | 990346 Propeller Nut                      |
|         |   | 991301 Cushion Hub                        |
| 203     | Yamaha® Outboards & Sterndrives<br>(V6 Gearcase • 115-130 HP; 150-250 HP; 1984 to Present)  | 991213 Forward Thrust Washer              |
|         |   | 991206 Aft Drive Adapter                  |
|         |   | 991301 Cushion Hub                        |
| 204     | Suzuki® Outboards<br>(V6 Gearcase • 150-300 HP)   | 991207 Forward Thrust Washer              |
|         |   | 991208 Aft Drive Adapter                  |
|         |   | 991301 Cushion Hub                        |
| 205     | Volvo® SX Sterndrives<br>(19 Tooth Spline; 1994 to Present)   | 991202 Forward Thrust Washer              |
|         |   | 991209 Aft Drive Adapter                  |
|         |   | 991301 Cushion Hub                        |
| 206     | Evinrude®/Johnson® Outboards - OMC® Sterndrives<br>(V4 Gearcase • 1968 to Present)  | 991210 Forward Thrust Washer              |
|         |   | 991211 Aft Drive Adapter                  |
|         |   | 991301 Cushion Hub                        |
| 207     | Honda® Outboards<br>(BFP 60, 115 & 130 HP, 1998 to Present; 75-90 HP, 1999 to Present)<br>(135 & 150 HP, 2004 to Present; 200 & 225 HP, 2002 to Present)  | 991207 Forward Thrust Washer              |
|         |   | 991205 Aft Drive Adapter                  |
|         |   | 991301 Cushion Hub                        |
| 208     | Yamaha® Outboards<br>(V4 Gearcase • 50-100 HP; Spline Front Washer)   | 991212 Forward Thrust Washer              |
|         |   | 991206 Aft Drive Adapter                  |
|         |   | 990338 (1) - Washer SS 30 x 17 x 2.5 mm   |
|         |   | 991301 Cushion Hub                        |
| 209     | Nissan®/Tohatsu® Outboards<br>(V4 Gearcase • 90-140 HP)   | 991213 Forward Thrust Washer              |
|         |   | 991214 Aft Drive Adapter                  |
|         |   | 991301 Cushion Hub                        |
| 210     | Suzuki® V4 Outboards<br>(V4 Gearcase • 60-140 HP)   | 991215 Forward Thrust Washer              |
|         |   | 991211 Aft Drive Adapter                  |
|         |   | 991301 Cushion Hub                        |
| 225     | Suzuki®/Johnson® Outboards<br>(DF 90, DF 100 & DF 115 HP 4-Stroke Applications)   | 991253 Forward Thrust Washer              |
|         |   | 991205 Aft Drive Adapter                  |
|         |   | 990337 (1) - Washer SS 32 x 19.2 x 2.5 mm |
|         |   | 991301 Cushion Hub                        |
| 226     | Suzuki®/Johnson® Outboards<br>(DF 140 HP 4-Stroke Applications)   | 991204 Forward Thrust Washer              |
|         |   | 991205 Aft Drive Adapter                  |
|         |   | 990337 (1) - Washer SS 32 x 19.2 x 2.5 mm |
|         |   | 991301 Cushion Hub                        |
| 227     | Suzuki® Outboards<br>(DF70A / DF80A / DF90A, 2009 to Present)   | 991312 Forward Thrust Washer              |
|         |   | 991206 Aft Drive Adapter                  |
|         |   | 990337 (1) - Washer SS 32 x 19.2 x 2.5 mm |
|         |   | 991301 Cushion Hub                        |

V4/V6 High Horsepower Hub Kits are available by special order. Add "SH" to the end of any V4/V6 Hub Kit number (except XHS II 227) to order. For details, contact MWM Customer Service at 800-369-4335.

# XHS® / XHS II® PROPELLER ACCESSORIES

| Hub Kit | Description  | Part Number / Description |                                    |
|---------|--|---------------------------|------------------------------------|
| 111     | Evinrude®/Johnson® Outboards<br>(3-3/8" Gearcase • 40-75 HP)   | 991247                    | Forward Thrust Washer              |
|         |  | 991232                    | Aft Drive Adapter                  |
|         |  | 991225                    | Urethane Cushion Hub               |
| 112     | Nissan®/Tohatsu® Outboards<br>(3-1/4" Gearcase • 50-70 HP)   | 991273                    | Forward Thrust Washer              |
|         |  | 991232                    | Aft Drive Adapter                  |
|         |  | 991225                    | Urethane Cushion Hub               |
| 113     | Honda® Outboards<br>(3-1/4" Gearcase • 35-60 HP)   | 991234                    | Forward Thrust Washer              |
|         |  | 991227                    | Aft Drive Adapter                  |
|         |  | 991225                    | Urethane Cushion Hub               |
| 114     | Mercury®/Mariner®/Force® Outboards<br>(3-1/4" Gearcase • 25-70 HP)   | 991236                    | Forward Thrust Washer              |
|         |  | 991227                    | Aft Drive Adapter                  |
|         |  | 991225                    | Urethane Cushion Hub               |
| 115     | Suzuki® Outboards<br>(3-1/4" Gearcase • 35-65 HP)  | 991239                    | Forward Thrust Washer              |
|         |  | 991232                    | Aft Drive Adapter                  |
|         |  | 990337                    | (2) - Washer SS 32 x 19.2 x 2.5 mm |
|         |  | 991225                    | Urethane Cushion Hub               |
| 116     | Nissan®/Tohatsu® Outboards<br>(3-1/4" Gearcase • 35-50 HP)   | 991241                    | Forward Thrust Washer              |
|         |  | 991227                    | Aft Drive Adapter                  |
|         |  | 990338                    | (2) - Washer SS 17 x 30 x 2.5 mm   |
|         |  | 991225                    | Urethane Cushion Hub               |
| 117     | Yamaha® Outboards<br>(3-1/4" Gearcase • 30-60 HP)  | 991243                    | Forward Thrust Washer              |
|         |  | 991227                    | Aft Drive Adapter                  |
|         |  | 990338                    | (1) - Washer SS 17 x 30 x 2.5 mm   |
|         |  | 991225                    | Urethane Cushion Hub               |
| 118     | Evinrude®/Johnson® Outboard<br>(3" Gearcase • 20-35 HP)  | 991237                    | Forward Thrust Washer              |
|         |  | 991229                    | Aft Drive Adapter                  |
|         |  | 991225                    | Urethane Cushion Hub               |
| 119     | Honda® Outboards<br>(3" Gearcase • 25 & 30 HP 4-Stroke Applications)   | 991233                    | Forward Thrust Washer              |
|         |  | 991226                    | Aft Drive Adapter                  |
|         |  | 991225                    | Urethane Cushion Hub               |
| 120     | Mercury®/Mariner®/Force® Outboards<br>(3" Gearcase • 9.9-25 HP)  | 991235                    | Forward Thrust Washer              |
|         |  | 991228                    | Aft Drive Adapter                  |
|         |  | 991225                    | Urethane Cushion Hub               |
| 121     | Suzuki® Outboards<br>(3" Gearcase • 25-30 HP)<br>Evinrude®/Johnson® Outboards<br>(3" Gearcase • 25 HP 4-Stroke & 30 HP 4-Stroke; 2004-2007)                      | 991238                    | Forward Thrust Washer              |
|         |  | 991230                    | Aft Drive Adapter                  |
|         |  | 990338                    | (1) - Washer SS 17 x 30 x 2.5 mm   |
|         |  | 991225                    | Urethane Cushion Hub               |
| 122     | Nissan®/Tohatsu® Outboards<br>(3" Gearcase • 25-30 HP)<br>Mercury®/Mariner®/Sea Ray® Outboards<br>(3" Gearcase • 25 & 30 HP 4-Stroke - Not Bigfoot Applications) | 991240                    | Forward Thrust Washer              |
|         |  | 991226                    | Aft Drive Adapter                  |
|         |  | 991225                    | Urethane Cushion Hub               |
| 123     | Yamaha® Outboards<br>(3" Gearcase • 20-30 HP)  | 991242                    | Forward Thrust Washer              |
|         |  | 991230                    | Aft Drive Adapter                  |
|         |  | 990338                    | (1) - Washer SS 17 x 30 x 2.5 mm   |
|         |  | 991225                    | Urethane Cushion Hub               |
|         | XHS II Standard Cushion Hub  | 991301                    | Delrin Cushion Hub                 |
|         | XHS II High Horsepower Inner Hub (Mercury® Part #850821A2)   | 991372                    | Solid Hub                          |
|         | V4 Gearcase Adapter Ring   | 991216                    | V4 Adapter Ring                    |
|         | 20-30 Horsepower Gearcase Adapter Ring   | 991244                    | Package Includes All Three Sizes   |
|         | XHS 9.9 HP - 70 HP Standard Cushion Hub  | 991225                    | Urethane Cushion Hub               |

# PROPELLER CROSS REFERENCE

---

---

**MWM ALPHA-NUMERIC CROSS REFERENCE  
(PAGE B2-B4)**

**MWM - TURNING POINT® CROSS REFERENCE  
(PAGE B4)**

**MWM - SOLAS® CROSS REFERENCE  
(PAGE B5)**

**MWM - QUICKSILVER® CROSS REFERENCE  
(PAGE B6)**

**XHS® / XHS II® HUB SYSTEM CROSS REFERENCE  
(PAGE B7)**

**OEM CROSS REFERENCE  
(PAGES B8-B34)**

*Propeller dimensions and performance may vary from OEM propeller.  
Product names may belong to Original Equipment Manufacturer.*



# MICHIGAN WHEEL ALPHA-NUMERIC CROSS REFERENCE

| Alpha<br>Numeric | Status/Year<br>Numeric<br>Discontinued | Alpha<br>Numeric | Status/Year<br>Numeric<br>Discontinued | Alpha<br>Numeric | Status/Year<br>Numeric<br>Discontinued |
|------------------|--|------------------|--|------------------|--|
| AJC-63           | 152001                                 | Dis. 1992        | PJ-10                                  | 012007           | Current                                |
| AJC-317          | 016002                                 | Current          | PJ-11                                  | 012008           | Current                                |
| AJC-318          | 012062                                 | Dis. 1990        | PJ-13                                  | 012009           | Dis. 1994                              |
| AJC-417          | 012063                                 | Dis. 1996        | PJ-15                                  | 012010           | Dis. 2007                              |
| AJC-418          | 012064                                 | Dis. 1992        | PJ-16                                  | 012011           | Current                                |
| AJC-469          | 012065                                 | Dis. 1992        | PJ-18                                  | 012013           | Current                                |
| AM-416           | 012066                                 | Dis. 1991        | PJ-19                                  | 012109           | Current                                |
| AM-431           | 012067                                 | Dis. 2007        | PJ-21                                  | 012014           | Dis. 2010                              |
| AMC-128-C        | 071010                                 | Dis. 1995        | PJ-22                                  | 012015           | Current                                |
| AMC-152-C        | 071021                                 | Dis. 1995        | PJ-24                                  | 012016           | Current                                |
| AMC-308          | 072014                                 | Current          | PJ-27                                  | 012019           | Dis. 1996                              |
| AMC-310          | 072131                                 | Current          | PJ-28                                  | 012020           | Dis. 1990                              |
| AMC-314          | 072133                                 | Current          | PJ-29                                  | 012021           | Current                                |
| AMC-316          | 072134                                 | Dis. 2006        | PJ-30                                  | 012022           | Dis. 2008                              |
| AMC-394          | 072132                                 | Current          | PJ-31                                  | 012023           | Current                                |
| AMC-422          | 012068                                 | Dis. 2008        | PJ-32                                  | 012024           | Current                                |
| AMC-444          | 012070                                 | Dis. 1991        | PJ-33                                  | 012025           | Dis. 2011                              |
| AMC-445          | 012071                                 | Dis. 1992        | PJ-40                                  | 012026           | Dis. 2006                              |
| AMC-448          | 012072                                 | Dis. 1996        | PJ-41                                  | 012027           | Dis. 2008                              |
| AMC-490          | 152002                                 | Dis. 2003        | PJ-42                                  | 012028           | Dis. 2007                              |
| AMC-503          | 032073                                 | Dis. 1991        | PJ-44                                  | 012029           | Dis. 1993                              |
| AMC-506          | 032074                                 | Dis. 1991        | PJ-45                                  | 012030           | Current                                |
| AMC-535          | 152003                                 | Dis. 1996        | PJ-47                                  | 012031           | Dis. 2006                              |
| AMC-577-S        | 032075                                 | Dis. 1991        | PJ-49                                  | 012032           | Current                                |
| AMC-580-S        | 032077                                 | Dis. 2006        | PJ-50                                  | 012033           | Dis. 2003                              |
| C-15             | 152011                                 | Dis. 1993        | PJ-51                                  | 012034           | Dis. 1991                              |
| C-18             | 152012                                 | Dis. 1991        | PJ-53                                  | 012035           | Dis. 1992                              |
| DQ-320           | 012074                                 | Dis. 2006        | PJ-58                                  | 012036           | Current                                |
| DQ-328           | 012075                                 | Dis. 2007        | PJ-58-C                                | 011018           | Dis. 1990                              |
| DQ-430           | 032078                                 | Dis. 1991        | PJ-59                                  | 012037           | Current                                |
| E-40             | 152013                                 | Dis. 1990        | PJ-59-C                                | 011019           | Dis. 1990                              |
| EWC-19           | 012076                                 | Dis. 2006        | PJ-60                                  | 012038           | Dis. 2007                              |
| EWC-28           | 012077                                 | Dis. 1987        | PJ-60-C                                | 011020           | Dis. 1990                              |
| EWC-29           | 012078                                 | Dis. 1988        | PJ-61                                  | 012039           | Limited Inv.                           |
| G-20             | 072017                                 | Dis. 2010        | PJ-62                                  | 012040           | Dis. 2008                              |
| G-30             | 152014                                 | Dis. 2005        | PJ-73                                  | 012041           | Dis. 1996                              |
| G-40             | 152015                                 | Dis. 1996        | PJ-74                                  | 012042           | Dis. 2005                              |
| G-45             | 152016                                 | Dis. 1992        | PJ-75                                  | 012043           | Dis. 2005                              |
| G-50             | 152017                                 | Dis. 1996        | PJ-76                                  | 012044           | Dis. 2008                              |
| GC-54            | 072018                                 | Dis. 1996        | PJ-77                                  | 012045           | Dis. 2008                              |
| GC-55            | 072019                                 | Dis. 1996        | PJ-78                                  | 012046           | Dis. 1994                              |
| K-40             | 032079                                 | Dis. 1992        | PJ-79                                  | 012048           | Dis. 2000                              |
| K-50             | 032080                                 | Dis. 1992        | PJ-80                                  | 012049           | Dis. 1996                              |
| K-70             | 032081                                 | Dis. 1992        | PJ-81                                  | 012050           | Dis. 1996                              |
| K-74             | 032082                                 | Dis. 1992        | PJ-82                                  | 012051           | Dis. 1996                              |
| PC-4             | 072020                                 | Dis. 1991        | PJ-83-C                                | 011005           | Current                                |
| PC-5             | 072120                                 | Dis. 1992        | PJ-87                                  | 012047           | Current                                |
| PC-6             | 072021                                 | Dis. 1996        | PJ-88-C                                | 011001           | Current                                |
| PC-9             | 072022                                 | Dis. 1996        | PJ-89-C                                | 011002           | Current                                |
| PC-10            | 072023                                 | Dis. 1996        | PJ-90-C                                | 011003           | Current                                |
| PC-12            | 072024                                 | Dis. 2006        | PJ-91-C                                | 011004           | Current                                |
| PC-20            | 072026                                 | Dis. 2006        | PJ-94                                  | 012053           | Dis. 2006                              |
| PC-24            | 072121                                 | Dis. 2006        | PJ-95                                  | 012054           | Current                                |
| PC-26            | 072125                                 | Dis. 1996        | PJ-96                                  | 012055           | Current                                |
| PC-28            | 072122                                 | Dis. 2006        | PJ-97                                  | 012056           | Current                                |
| PC-32            | 072121                                 | Dis. 2006        | PJ-98                                  | 012057           | Current                                |
| PC-90            | 072126                                 | Dis. 1994        | PJ-199-C                               | 011015           | Dis. 2008                              |
| PC-112           | 072123                                 | Current          | PJ-200                                 | 012059           | Dis. 1996                              |
| PJ-3             | 012001                                 | Dis. 2007        | PJ-200-C                               | 011016           | Current                                |
| PJ-5             | 012002                                 | Dis. 1996        | PJ-201-C                               | 011006           | Current                                |
| PJ-6             | 012003                                 | Dis. 1996        | PJ-202-C                               | 011007           | Current                                |
| PJ-7             | 012004                                 | Dis. 2006        | PJ-203-C                               | 011008           | Current                                |
| PJ-8             | 012005                                 | Current          | PJ-204-C                               | 011009           | Current                                |
| PJ-9             | 012006                                 | Dis. 2008        | PJ-205-C                               | 011010           | Dis. 2010                              |
| PJ-300           | 012060                                 | Dis. 2009        |  |                  |  |
| PM-4             | 032012                                 | Dis. 1992        |  |                  |  |
| PM-6             | 032013                                 | Dis. 1996        |  |                  |  |
| PM-8             | 032014                                 | Dis. 2003        |  |                  |  |
| PM-10            | 032015                                 | Dis. 1994        |  |                  |  |
| PM-11            | 032016                                 | Dis. 1994        |  |                  |  |
| PM-16            | 032017                                 | Dis. 1992        |  |                  |  |
| PM-18            | 032018                                 | Dis. 1992        |  |                  |  |
| PM-19            | 032019                                 | Dis. 2008        |  |                  |  |
| PM-20            | 032020                                 | Current          |  |                  |  |
| PM-21            | 032021                                 | Current          |  |                  |  |
| PM-22-C          | 031047                                 | Dis. 2008        |  |                  |  |
| PM-23-C          | 031048                                 | Current          |  |                  |  |
| PM-24-C          | 031049                                 | Current          |  |                  |  |
| PM-26            | 032111                                 | Dis. 1993        |  |                  |  |
| PM-27            | 032025                                 | Dis. 1996        |  |                  |  |
| PM-28            | 032027                                 | Dis. 1992        |  |                  |  |
| PM-29            | 032028                                 | Dis. 1992        |  |                  |  |
| PM-30            | 032112                                 | Dis. 1993        |  |                  |  |
| PM-39            | 032030                                 | Dis. 1987        |  |                  |  |
| PM-40            | 032031                                 | Dis. 1987        |  |                  |  |
| PM-42            | 032032                                 | Dis. 1987        |  |                  |  |
| PM-54            | 032033                                 | Dis. 1991        |  |                  |  |
| PM-55            | 032034                                 | Dis. 1994        |  |                  |  |
| PM-56            | 032035                                 | Dis. 1993        |  |                  |  |
| PM-60            | 032036                                 | Dis. 1987        |  |                  |  |
| PM-61            | 032037                                 | Dis. 1987        |  |                  |  |
| PM-62            | 032038                                 | Dis. 1987        |  |                  |  |
| PM-211-C         | 031021                                 | Dis. 2008        |  |                  |  |
| PM-213-C         | 031022                                 | Current          |  |                  |  |
| PM-215-C         | 031023                                 | Current          |  |                  |  |
| PM-217-C         | 031024                                 | Current          |  |                  |  |
| PM-219-C         | 031025                                 | Current          |  |                  |  |
| PM-221-C         | 031026                                 | Current          |  |                  |  |
| PM-223-C         | 031027                                 | Dis. 2006        |  |                  |  |
| PM-315-C         | 031041                                 | Current          |  |                  |  |
| PM-317-C         | 031042                                 | Current          |  |                  |  |
| PM-319-C         | 031043                                 | Current          |  |                  |  |
| PM-321-C         | 031044                                 | Current          |  |                  |  |
| PM-323-C         | 031045                                 | Current          |  |                  |  |
| PM-513           | 032039                                 | Dis. 2008        |  |                  |  |
| PM-515           | 032040                                 | Current          |  |                  |  |
| PM-518           | 032041                                 | Current          |  |                  |  |
| PM-521           | 032042                                 | Current          |  |                  |  |
| PM-524           | 032043                                 | Current          |  |                  |  |
| PM-527           | 032044                                 | Current          |  |                  |  |
| PM-530           | 032045                                 | Current          |  |                  |  |
| PM-600-C         | 031015                                 | Current          |  |                  |  |
| PM-612-C         | 031016                                 | Current          |  |                  |  |
| PM-613-C         | 031017                                 | Current          |  |                  |  |
| PM-614-C         | 031018                                 | Current          |  |                  |  |
| PM-615-C         | 031019                                 | Current          |  |                  |  |
| PM-617-C         | 031020                                 | Current          |  |                  |  |
| PR-4             | 072027                                 | Dis. 1991        |  |                  |  |
| PR-8             | 072028                                 | Dis. 1996        |  |                  |  |
| PR-10            | 072029                                 | Dis. 1991        |  |                  |  |
| PR-20            | 012079                                 | Dis. 1993        |  |                  |  |
| PR-22            | 012080                                 | Dis. 1993        |  |                  |  |
| PR-24            | 012081                                 | Dis. 1992        |  |                  |  |
| PR-26            | 012082                                 | Dis. 1992        |  |                  |  |
| PR-31            | 032083                                 | Dis. 1996        |  |                  |  |
| PR-33            | 032084                                 | Dis. 2007        |  |                  |  |
| PR-35            | 032085                                 | Dis. 2007        |  |                  |  |
| PR-37            | 032086                                 | Dis. 2006        |  |                  |  |

CAN'T FIND YOUR ALPHA-NUMERIC PART NUMBER LISTED ABOVE?  
FOR ADDITIONAL ASSISTANCE CONTACT MICHIGAN WHEEL MARINE CUSTOMER SERVICE AT 800-369-4335

# MICHIGAN WHEEL ALPHA-NUMERIC CROSS REFERENCE

| Alpha<br>Numeric | Status/Year<br>Numeric<br>Discontinued | Alpha<br>Numeric | Status/Year<br>Numeric<br>Discontinued | Alpha<br>Numeric | Status/Year<br>Numeric<br>Discontinued |
|------------------|--|------------------|--|------------------|--|
| PR-39            | 032087                                 | Dis. 2007        | PR-409                                 | 072063           | Dis. 1987                              |
| PR-43            | 032088                                 | Dis. 1994        | PR-412                                 | 072064           | Dis. 1987                              |
| PR-74            | 072030                                 | Dis. 1991        | PR-413                                 | 072065           | Dis. 1987                              |
| PR-76            | 072031                                 | Dis. 1992        | PR-416                                 | 072066           | Dis. 1987                              |
| PR-78            | 072032                                 | Dis. 2007        | PR-417                                 | 072067           | Dis. 1987                              |
| PR-80            | 072033                                 | Dis. 2006        | PR-420                                 | 012095           | Dis. 1993                              |
| PR-82            | 072034                                 | Dis. 2005        | PR-421                                 | 016006           | Dis. 1992                              |
| PR-90            | 012083                                 | Dis. 1992        | PR-422                                 | 012096           | Dis. 1992                              |
| PR-92            | 012084                                 | Dis. 1993        | PR-423                                 | 016007           | Dis. 1991                              |
| PR-94            | 012085                                 | Dis. 1992        | PR-424                                 | 012097           | Dis. 1994                              |
| PR-95            | 016004                                 | Dis. 1991        | PR-425                                 | 016008           | Dis. 1992                              |
| PR-96            | 012086                                 | Dis. 1993        | PR-426                                 | 012098           | Dis. 1992                              |
| PR-97            | 016005                                 | Dis. 1992        | PR-427                                 | 016009           | Dis. 1987                              |
| PR-105           | 012087                                 | Dis. 1993        | PR-432                                 | 072114           | Dis. 1993                              |
| PR-109           | 012088                                 | Dis. 1992        | PR-434                                 | 072068           | Dis. 1996                              |
| PR-115           | 012089                                 | Dis. 2008        | PR-552                                 | 072069           | Dis. 1992                              |
| PR-118           | 012090                                 | Dis. 2007        | PR-553                                 | 072070           | Dis. 1996                              |
| PR-120           | 012091                                 | Current          | PR-554                                 | 072071           | Dis. 1992                              |
| PR-122           | 012092                                 | Current          | PR-555                                 | 072072           | Dis. 1990                              |
| PR-124           | 012093                                 | Dis. 2007        | PR-884                                 | 072073           | Dis. 1991                              |
| PR-126           | 012094                                 | Dis. 2007        | PS-1                                   | 062001           | Dis. 1992                              |
| PR-130           | 072035                                 | Dis. 1991        | PS-2                                   | 062002           | Dis. 1992                              |
| PR-132           | 072036                                 | Dis. 1991        | PS-5                                   | 062003           | Dis. 1992                              |
| PR-134           | 072037                                 | Dis. 1991        | PS-6                                   | 062004           | Dis. 1993                              |
| PR-136           | 072038                                 | Dis. 1991        | PS-7                                   | 062005           | Dis. 1991                              |
| PR-138           | 072039                                 | Dis. 1991        | PS-25                                  | 152020           | Dis. 1992                              |
| PR-151           | 032089                                 | Dis. 2004        | PS-40                                  | 152021           | Dis. 1993                              |
| PR-153           | 032090                                 | Dis. 2004        | PS-71                                  | 152023           | Dis. 1992                              |
| PR-155           | 032091                                 | Dis. 2004        | PS-72                                  | 152024           | Dis. 1991                              |
| PR-155-C         | 031001                                 | Dis. 2003        | PS-73                                  | 152025           | Dis. 1992                              |
| PR-157           | 032092                                 | Dis. 2004        | PS-513                                 | 062006           | Dis. 1991                              |
| PR-157-C         | 031002                                 | Dis. 2003        | PS-515                                 | 062007           | Dis. 1991                              |
| PR-159           | 032093                                 | Dis. 2004        | PS-518                                 | 062008           | Dis. 1991                              |
| PR-159-C         | 031003                                 | Dis. 2003        | PS-521                                 | 062009           | Dis. 1991                              |
| PR-161           | 032094                                 | Dis. 2004        | PS-524                                 | 062010           | Dis. 1991                              |
| PR-161-C         | 031004                                 | Dis. 2003        | PS-527                                 | 062011           | Dis. 1991                              |
| PR-163           | 032095                                 | Dis. 2004        | PY-315-C                               | 101001           | Dis. 1997                              |
| PR-163-C         | 031005                                 | Dis. 1994        | PY-317-C                               | 101003           | Dis. 1997                              |
| PR-248           | 072047                                 | Dis. 1987        | PY-319-C                               | 101005           | Dis. 1997                              |
| PR-250           | 072048                                 | Dis. 1987        | PY-321-C                               | 101007           | Dis. 1997                              |
| PR-256           | 072049                                 | Dis. 1987        | PY-323-C                               | 101009           | Dis. 1994                              |
| PR-258           | 072050                                 | Dis. 1987        | PY-415-C                               | 101010           | Dis. 1997                              |
| PR-260           | 072051                                 | Dis. 1987        | PY-417-C                               | 101011           | Dis. 1997                              |
| PR-264           | 072053                                 | Dis. 1987        | PY-419-C                               | 101012           | Dis. 1997                              |
| PR-276           | 072054                                 | Dis. 2007        | PY-421-C                               | 101013           | Dis. 1997                              |
| PR-278           | 072055                                 | Current          | PY-423-C                               | 101014           | Dis. 1994                              |
| PR-333           | 032096                                 | Dis. 1993        | SA-10                                  | 152030           | Dis. 1994                              |
| PR-335           | 032097                                 | Dis. 1996        | SAC-371                                | 152034           | Dis. 1992                              |
| PR-335-C         | 031007                                 | Dis. 1990        | SMC-7                                  | 152029           | Dis. 1987                              |
| PR-337           | 032098                                 | Dis. 1995        | SMC-12                                 | 012100           | Dis. 1996                              |
| PR-337-C         | 142002                                 | Dis. 2009        | SMC-18                                 | 012101           | Dis. 2007                              |
| PR-339           | 032099                                 | Dis. 2007        | SMC-34                                 | 016011           | Dis. 1992                              |
| PR-339-C         | 031009                                 | Dis. 1990        | SMC-38                                 | 016013           | Dis. 1992                              |
| PR-343           | 032100                                 | Dis. 1996        | SMC-39                                 | 012102           | Current                                |
| PR-343-C         | 031010                                 | Dis. 1990        | SMC-46                                 | 072074           | Dis. 1994                              |
| PR-345           | 032101                                 | Dis. 1993        | SMC-47                                 | 012063           | Dis. 1996                              |
| PR-345-C         | 031011                                 | Dis. 1990        | SMC-292                                | 082022           | Dis. 2007                              |
| PR-396           | 072056                                 | Dis. 1987        | SMC-293                                | 082021           | Dis. 2011                              |
| PR-397           | 072057                                 | Dis. 1987        | SMC-294                                | 082024           | Dis. 1996                              |
| PR-400           | 072058                                 | Dis. 1987        | SMC-295                                | 082023           | Dis. 2007                              |
| PR-401           | 072059                                 | Dis. 1987        | SMC-304                                | 012103           | Dis. 1992                              |
| PR-404           | 072060                                 | Dis. 1987        | SMC-308                                | 012104           | Dis. 1992                              |
| PR-405           | 072061                                 | Dis. 1987        | SMC-312                                | 012105           | Dis. 1992                              |
| PR-408           | 072062                                 | Dis. 1987        | SMC-335                                | 082025           | Dis. 1997                              |
| SMC-339          | 082026                                 | Dis. 1997        | SMC-374-C                              | 031035           | Dis. 2003                              |
| SMC-340          | 082059                                 | Dis. 1997        | SMC-376-C                              | 031036           | Dis. 2003                              |
| SMC-341          | 082060                                 | Dis. 1997        | SMC-378-C                              | 031037           | Dis. 2005                              |
| SMC-342          | 082027                                 | Dis. 1997        | SMC-380-C                              | 031038           | Dis. 2005                              |
| SMC-343          | 082028                                 | Dis. 1997        | SMC-382-C                              | 031039           | Dis. 2005                              |
| SMC-344          | 082029                                 | Dis. 1997        | SMC-384-C                              | 031040           | Dis. 1997                              |
| SMC-345          | 082030                                 | Dis. 1997        | SMC-434                                | 036004           | Dis. 1992                              |
| SMC-346          | 082031                                 | Dis. 1997        | SMC-435                                | 036005           | Dis. 1992                              |
| SMC-350          | 082053                                 | Dis. 1996        | SMC-436                                | 036006           | Dis. 1992                              |
| SMC-351          | 082036                                 | Dis. 1995        | SMC-437                                | 036007           | Dis. 1992                              |
| SMC-374-C        | 031035                                 | Dis. 2003        | SMC-438                                | 036008           | Dis. 1991                              |
| SMC-376-C        | 031036                                 | Dis. 2003        | SMC-439                                | 036009           | Dis. 1992                              |
| SMC-378-C        | 031037                                 | Dis. 2005        | SMC-440                                | 036010           | Dis. 1987                              |
| SMC-380-C        | 031038                                 | Dis. 2005        | SMC-504-C                              | 031034           | Dis. 2003                              |
| SMC-382-C        | 031039                                 | Dis. 2005        | SMC-530                                | 072078           | Dis. 1987                              |
| SMC-384-C        | 031040                                 | Dis. 1997        | SMC-556                                | 072077           | Dis. 1987                              |
| SMC-434          | 036004                                 | Dis. 1992        | SMC-566                                | 072076           | Dis. 1987                              |
| SMC-435          | 036005                                 | Dis. 1992        | SMC-570                                | 072079           | Dis. 1987                              |
| SMC-436          | 036006                                 | Dis. 1992        | SMC-582                                | 072086           | Dis. 1987                              |
| SMC-437          | 036007                                 | Dis. 1992        | SMC-592                                | 072083           | Dis. 1987                              |
| SMC-438          | 036008                                 | Dis. 1991        | SMC-604                                | 072084           | Dis. 1987                              |
| SMC-439          | 036009                                 | Dis. 1992        | SMC-606                                | 072085           | Dis. 1987                              |
| SMC-440          | 036010                                 | Dis. 1987        | SMC-635                                | 152035           | Dis. 1991                              |
| SMC-504-C        | 031034                                 | Dis. 2003        | SMC-637                                | 152036           | Dis. 1992                              |
| SMC-530          | 072078                                 | Dis. 1987        | SMC-713                                | 152037           | Dis. 1992                              |
| SMC-556          | 072077                                 | Dis. 1987        | SMC-715                                | 152038           | Dis. 1992                              |
| SMC-566          | 072076                                 | Dis. 1987        | SMC-720                                | 072088           | Dis. 1993                              |
| SMC-570          | 072079                                 | Dis. 1987        | SMC-721                                | 072090           | Dis. 1992                              |
| SMC-582          | 072086                                 | Dis. 1987        | SMC-733                                | 072092           | Dis. 1990                              |
| SMC-592          | 072083                                 | Dis. 1987        | SMC-734                                | 072093           | Dis. 1991                              |
| SMC-604          | 072084                                 | Dis. 1987        | SMC-735                                | 072095           | Dis. 1990                              |
| SMC-606          | 072085                                 | Dis. 1987        | SMC-736                                | 072089           | Dis. 1992                              |
| SMC-635          | 152035                                 | Dis. 1991        | SMC-737                                | 072091           | Dis. 1992                              |
| SMC-637          | 152036                                 | Dis. 1992        | SMC-744                                | 072097           | Dis. 1992                              |
| SMC-713          | 152037                                 | Dis. 1992        | SMC-750                                | 072099           | Dis. 1992                              |
| SMC-715          | 152038                                 | Dis. 1992        | SMC-751                                | 072098           | Dis. 1996                              |
| SMC-720          | 072088                                 | Dis. 1993        | SMC-760                                | 072096           | Dis. 1996                              |
| SMC-721          | 072090                                 | Dis. 1992        | SMC-765                                | 072101           | Dis. 1994                              |
| SMC-733          | 072092                                 | Dis. 1990        | SMC-768                                | 072103           | Dis. 1991                              |
| SMC-734          | 072093                                 | Dis. 1991        | SMC-769                                | 072104           | Dis. 1996                              |
| SMC-735          | 072095                                 | Dis. 1990        | SMC-773                                | 072105           | Dis. 1990                              |
| SMC-736          | 072089                                 | Dis. 1992        | SMC-774                                | 072106           | Dis. 1996                              |
| SMC-737          | 072091                                 | Dis. 1992        | SMC-800                                | 032104           | Dis. 1987                              |
| SMC-744          | 072097                                 | Dis. 1992        | SMC-801                                | 032103           | Dis. 1987                              |
| SMC-750          | 072099                                 | Dis. 1992        | SMC-802                                | 032106           | Dis. 1996                              |
| SMC-751          | 072098                                 | Dis. 1996        | SMC-803                                | 032105           | Dis. 1992                              |
| SMC-760          | 072096                                 | Dis. 1996        | SMC-804                                | 032108           | Dis. 1992                              |
| SMC-765          | 072101                                 | Dis. 1994        | SMC-805                                | 032107           | Dis. 1992                              |
| SMC-768          | 072103                                 | Dis. 1991        | SMC-806                                | 032110           | Dis. 1990                              |
| SMC-769          | 072104                                 | Dis. 1996        | SMC-807                                | 032109           | Dis. 1995                              |
| SMC-773          | 072105                                 | Dis. 1990        | SMC-808                                | 072112           | Dis. 1992                              |
| SMC-774          | 072106                                 | Dis. 1996        | SMC-809                                | 072113           | Dis. 1990                              |
| SMC-800          | 032104                                 | Dis. 1987        | SMC-862                                | 012106           | Dis. 1992                              |
| SMC-801          | 032103                                 | Dis. 1987        | SMC-864                                | 012107           | Dis. 1992                              |
| SMC-802          | 032106                                 | Dis. 1996        |  |                  |  |
| SMC-803          | 032105                                 | Dis. 1992        |  |                  |  |
| SMC-804          | 032108                                 | Dis. 1992        |  |                  |  |
| SMC-805          | 032107                                 | Dis. 1992        |  |                  |  |
| SMC-806          | 032110                                 | Dis. 1990        |  |                  |  |
| SMC-807          | 032109                                 | Dis. 1995        |  |                  |  |
| SMC-808          | 072112                                 | Dis. 1992        |  |                  |  |
| SMC-809          | 072113                                 | Dis. 1990        |  |                  |  |
| SMC-862          | 012106                                 | Dis. 1992        |  |                  |  |
| SMC-864          | 012107                                 | Dis. 1992        |  |                  |  |

# MICHIGAN WHEEL ALPHA-NUMERIC CROSS REFERENCE

| Alpha<br>Numeric | Status/Year<br>Numeric<br>Discontinued | Alpha<br>Numeric | Status/Year<br>Numeric<br>Discontinued | Alpha<br>Numeric | Status/Year<br>Numeric<br>Discontinued |
|------------------|--|------------------|--|------------------|--|
| SMC-885          | 082035 Dis. 1992                       | SSM-272-C        | 033020 Dis. 1994                       | SSO-817-C        | 013015 Dis. 1995                       |
| SMC-898          | 082037 Dis. 1994                       | SSM-292-C        | 033021 Dis. 1995                       | SSO-819-C        | 013016 Dis. 1994                       |
| SMC-900          | 082041 Dis. 1992                       | SSM-312-C        | 033022 Dis. 1996                       | SSO-821-C        | 013017 Dis. 1996                       |
| SMC-906          | 082043 Dis. 1996                       | SSM-350-C        | 033007 Dis. 2005                       | SSO-922-C        | 013007 Dis. 1990                       |
| SMC-922          | 082047 Dis. 1992                       | SSM-354-C        | 033008 Dis. 2005                       | SSO-924-C        | 013008 Dis. 1990                       |
| SMC-925          | 082049 Dis. 1995                       | SSM-358-C        | 033009 Dis. 2005                       | SSO-926-C        | 013009 Dis. 1990                       |
| SMC-929          | 082051 Dis. 1991                       | SSM-615-II-C     | 033016 Dis. 2005                       | SSV-171-C        | 083001 Dis. 2006                       |
| SMC-940          | 082052 Dis. 1992                       | SSM-617-II-C     | 033017 Dis. 2006                       | SSV-172-C        | 083002 Dis. 2006                       |
| SMC-944          | 082054 Dis. 1992                       | SSM-619-II-C     | 033018 Dis. 2006                       | SSV-192-C        | 083004 Dis. 2006                       |
| SPC-180          | 072107 Current                         | SSM-621-II-C     | 033019 Dis. 2006                       | SSV-211-C        | 083005 Dis. 2006                       |
| SPC-182          | 072108 Current                         | SSM-822-C        | 033013 Dis. 1990                       | SSV-212-C        | 083006 Dis. 2006                       |
| SPC-184          | 072109 Dis. 2006                       | SSM-824-C        | 033014 Dis. 1990                       | SSY-615-II-C     | 103025 Dis. 2006                       |
| SSC-315-II-C     | 073002 Dis. 2005                       | SSM-826-C        | 033015 Dis. 1990                       | SSY-617-II-C     | 103026 Dis. 2006                       |
| SSC-317-II-C     | 073003 Dis. 2005                       | SSO-315-C        | 013010 Dis. 2007                       | SSY-619-II-C     | 103027 Dis. 2006                       |
| SSC-319-II-C     | 073004 Dis. 2005                       | SSO-515-II-C     | 013011 Dis. 1990                       | SSY-621-II-C     | 103028 Dis. 1997                       |
| SSC-321-II-C     | 073005 Dis. 1996                       | SSO-517-C        | 013012 Dis. 1990                       | SSY-715-C        | 103016 Dis. 1991                       |
| SSC-614-C        | 073006 Dis. 1996                       | SSO-519-C        | 013013 Dis. 1990                       | SSY-717-C        | 103018 Dis. 2006                       |
| SSM-212-C        | 033001 Dis. 2006                       | SSO-521-C        | 013014 Dis. 1990                       | SSY-719-C        | 103020 Dis. 2006                       |
| SSM-245-C        | 033002 Dis. 2006                       | SSO-645-C        | 013001 Dis. 1990                       | SSY-721-C        | 103022 Dis. 2007                       |
| SSM-247-C        | 033003 Dis. 2006                       | SSO-647-C        | 013002 Dis. 1990                       | SSY-722-C        | 103050 Dis. 2003                       |
| SSM-249-C        | 033004 Dis. 2006                       | SSO-649-C        | 013003 Dis. 1990                       | SSY-723-C        | 103024 Dis. 2003                       |
| SSM-251-C        | 033005 Dis. 2005                       | SSO-651-C        | 013004 Dis. 1990                       | SSY-724-C        | 103052 Dis. 2003                       |
| SSM-253-C        | 033006 Dis. 2006                       | SSO-653-C        | 013005 Dis. 1990                       | SSY-726-C        | 103054 Dis. 2003                       |

CAN'T FIND YOUR ALPHA-NUMERIC PART NUMBER LISTED ABOVE?  
FOR ADDITIONAL ASSISTANCE CONTACT MICHIGAN WHEEL MARINE CUSTOMER SERVICE AT 800-369-4335

## TURNING POINT® - MICHIGAN WHEEL CROSS REFERENCE

| Turning Point®<br>Part # | Alternate<br>TP Part # | MWM<br>Part # | Turning Point®<br>Part # | Alternate<br>TP Part # | MWM<br>Part # | Turning Point®<br>Part # | Alternate<br>TP Part # | MWM<br>Part # |
|--------------------------|------------------------|---------------|--------------------------|------------------------|---------------|--------------------------|------------------------|---------------|
| E-1415                   |                        | 993042        | H1-1315                  |                        | 992113        | PA-1417                  | 3150 1710              | 993043        |
| E-1417                   |                        | 993043        | H1-1317                  |                        | 992114        | PA-1417-L                | 3150 1720              | 993053        |
| E-1419                   |                        | 993044        | H1-1319                  |                        | 992115        | PA-1419                  | 3150 1910              | 993044        |
| E-1421                   |                        | 993045        | H1-1321                  |                        | 992116        | PA-1419-L                | 3150 1920              | 993054        |
| E-1423                   |                        | 993046        | H1-1413                  |                        | 992112        | PA-1421                  | 3150 2110              | 993045        |
| E1-1012                  | 3130 1211              | 993405        | H2-1117                  | 2131 1710              | 992303        | PA-1421-L                | 3150 2120              | 993055        |
| E1-1013                  | 3130 1311              | 993406        | H2-1213                  | 2131 1310              | 992311        | PA-1423                  | 3150 2310              | 993046        |
| E1-1014                  | 3130 1411              | 993407        | H2-1215                  | 2131 1510              | 992312        | PA-1423-L                | 3150 2320              | 993056        |
| E1-1015                  | 3130 1511              | 993408        | H2-1315                  |                        | 992113        | PA1-1315                 | 3140 1510              | 993143        |
| E1-1315                  |                        | 993143        | H2-1317                  |                        | 992114        | PA1-1317                 | 3140 1710              | 993144        |
| E1-1317                  |                        | 993144        | H2-1319                  |                        | 992115        | PA1-1319                 | 3140 1910              | 993145        |
| E1-1319                  |                        | 993145        | H2-1321                  |                        | 992116        | PA1-1321                 | 3140 2110              | 993146        |
| E1-1321                  |                        | 993146        | H2-1413                  |                        | 992112        | PA2-1315                 | 3141 1510              | 993143        |
| E2-1315                  |                        | 993143        | LE-1417                  | 2150 1711              | 992003        | PA2-1317                 | 3141 1710              | 993144        |
| E2-1317                  |                        | 993144        | LE-1419                  | 2150 1911              | 992004        | PA2-1319                 | 3141 1910              | 993145        |
| E2-1319                  |                        | 993145        | LE-1421                  | 2150 2111              | 992005        | PA2-1321                 | 3141 2110              | 993146        |
| E2-1321                  |                        | 993146        | LE-1423                  | 2150 2311              | 992006        | R1-1011                  | 2120 1110              | 992503        |
| H-1417                   |                        | 992003        | LE-1515                  | 2150 1511              | 992002        | R1-1013                  | 2120 1310              | 992505        |
| H-1419                   |                        | 992004        | LE1-1315                 | 2143 1511              | 992113        | R2-1011                  | 2121 1110              | 992503        |
| H-1421                   |                        | 992005        | LE1-1317                 | 2143 1711              | 992114        | R2-1013                  | 2121 1310              | 992505        |
| H-1423                   |                        | 992006        | LE1-1319                 | 2143 1911              | 992115        | R3-1011                  | 2122 1110              | 992503        |
| H-1515                   |                        | 992002        | LE1-1321                 | 2143 2111              | 992116        | R3-1013                  | 2122 1310              | 992505        |
| H1-1011                  | 2130 1110              | 992404        | LE1-1413                 | 2143 1311              | 992112        | VO-1517                  | 3152 1710              | 993023        |
| H1-1012                  | 2130 1210              | 992405        | LE2-1315                 | 2143 1511              | 992113        | VO-1517-L                | 3152 1720              | 993033        |
| H1-1013                  | 2130 1310              | 992406        | LE2-1317                 | 2143 1711              | 992114        | VO-1519                  | 3152 1910              | 993024        |
| H1-1014                  | 2130 1410              | 992407        | LE2-1319                 | 2143 1911              | 992115        | VO-1519-L                | 3152 1920              | 993034        |
| H1-1015                  | 2130 1510              | 992408        | LE2-1321                 | 2143 2111              | 992116        | VO-1521                  | 3152 2110              | 993025        |
| H1-1210                  | 2130 1010              | 992602        | LE2-1413                 | 2143 1311              | 992112        | VO-1521-L                | 3152 2120              | 993035        |

# SOLAS® - MICHIGAN WHEEL CROSS REFERENCE

| Solas®<br>Part # | MWM<br>Part # | Solas®<br>Part # | MWM<br>Part # | Solas®<br>Part # | MWM<br>Part # |
|------------------|---------------|------------------|---------------|------------------|---------------|
| 1111-093-07      | 032056        | 2511-142-23      | 011010        | 4311-116-14      | 032041        |
| 1111-093-08      | 032054        | 2511-143-21      | 011009        | 4311-118-11      | 032044        |
| 1111-093-09      | 032052        | 2511-145-19      | 011008        | 4311-120-10      | 032045        |
| 1111-093-10      | 032050        | 2511-148-17      | 011007        | 4331-110-15      | 395930        |
| 1211-100-14      | 031047        | 2511-150-15      | 011006        | 4331-111-13      | 395929        |
| 1211-101-13      | 031048        | 2511-155-13      | 011016        | 4411-138-13      | 031202        |
| 1211-105-11      | 031049        | 2551-140-24      | 345037        | 4411-140-11      | 031200        |
| 1231-100-15      | 305130        | 2551-143-22      | 345051        | 8611-142-23      | 161005        |
| 1231-101-13      | 305129        | 2551-145-21      | 345034        | 8611-143-21      | 161004        |
| 1311-110-15      | 031019        | 2551-148-16      | 345031        | 8611-145-19      | 161003        |
| 1311-111-13      | 031047        | 2551-148-17      | 345032        | 8611-148-17      | 161002        |
| 1311-111-14      | 031018        | 2551-148-19      | 345033        | 8611-150-15      | 161001        |
| 1311-114-12      | 031017        | 2552-145-21      | 345064        | 8651-148-16      | 346031        |
| 1311-116-11      | 031016        | 2552-148-17      | 345062        | 8651-148-17      | 346032        |
| 1311-120-10      | 032142        | 2552-148-19      | 345063        | 8651-148-19      | 346033        |
| 1311-121-09      | 031015        | 2553-140-23      | 435035        | 8651-148-21      | 346034        |
| 1411-130-19      | 031043        | 2553-140-25      | 435036        | 8651-148-23      | 346035        |
| 1411-130-21      | 031044        | 3011-085-08      | 102002        | 8652-148-17      | 346062        |
| 1411-133-17      | 031042        | 3111-093-08      | 102003        | 8652-148-19      | 346063        |
| 1411-135-15      | 031041        | 3111-093-09      | 102004        | 8652-148-23      | 346065        |
| 1411-138-13      | 031202        | 3111-093-10      | 102005        | 9411-132-19      | 992115        |
| 1411-140-11      | 031054        | 3211-099-09      | 022001        | 9411-132-21      | 992116        |
| 1431-130-19      | 335132        | 3211-099-10      | 022002        | 9411-133-17      | 992114        |
| 1431-130-21      | 335133        | 3211-099-12      | 022003        | 9411-135-15      | 992113        |
| 1431-133-17      | 335131        | 3231-100-15      | 305930        | 9431-130-19      | 993145        |
| 1431-135-15      | 335130        | 3231-101-13      | 305929        | 9431-130-21      | 993146        |
| 1451-139-17      | 335131        | 3311-110-15      | 032040        | 9431-133-17      | 993144        |
| 1451-139-19      | 335132        | 3311-111-13      | 032042        | 9431-135-15      | 993143        |
| 1451-139-21      | 335133        | 3311-111-14      | 032041        | 9431-138-13      | 992112        |
| 1451-139-23      | 334135        | 3311-114-12      | 032043        | 9432-130-19      | 993155        |
| 1451-139-25      | 335135        | 3311-116-11      | 032044        | 9432-133-17      | 993154        |
| 1511-148-16      | 345131        | 3311-118-11      | 032044        | 9432-135-15      | 993153        |
| 1551-140-24      | 345139        | 3311-120-10      | 032045        | 9511-143-21      | 992005        |
| 1551-143-22      | 345141        | 3311-121-09      | 032045        | 9511-145-19      | 992004        |
| 1551-145-21      | 345134        | 3331-110-15      | 395930        | 9511-148-17      | 992003        |
| 1551-148-16      | 345131        | 3331-111-13      | 395929        | 9511-150-15      | 992002        |
| 1551-148-17      | 345132        | 3411-130-19      | 101034        | 9513-143-19      | 992204        |
| 1551-148-19      | 345133        | 3411-130-21      | 101035        | 9513-148-17      | 992203        |
| 1552-143-22      | 345165        | 3411-133-17      | 101033        | 9513-148-15      | 992202        |
| 1552-145-21      | 345164        | 3411-135-15      | 101032        | 9531-140-19      | 993044        |
| 1552-148-17      | 345162        | 3411-138-13      | 101031        | 9531-140-21      | 993045        |
| 1552-148-19      | 345163        | 3411-140-11      | 101036        | 9531-140-23      | 993046        |
| 1553-140-23      | 435135        | 3431-130-21      | 335933        | 9531-143-17      | 993043        |
| 1553-140-25      | 435136        | 3431-133-17      | 325031        | 9531-145-15      | 993042        |
| 2011-085-09      | 012007        | 3431-135-15      | 325030        | 9532-140-19      | 993054        |
| 2111-093-07      | 012112        | 3441-133-17      | 335931        | 9532-140-21      | 993055        |
| 2111-093-10      | 012111        | 3441-133-19      | 335932        | 9532-140-23      | 993056        |
| 2211-101-13      | 012056        | 3441-138-15      | 335930        | 9532-143-17      | 993053        |
| 2211-105-11      | 012055        | 3511-145-19      | 101028        | 9532-145-15      | 993052        |
| 2231-100-15      | 305030        | 3511-148-17      | 101027        | 9553-140-21      | 993205        |
| 2231-101-13      | 305029        | 3551-140-24      | 345936        | 9553-140-23      | 993206        |
| 2311-120-17      | 011028        | 3551-143-22      | 345935        | 9553-141-19      | 993204        |
| 2311-123-15      | 011027        | 3551-145-21      | 345934        | 9553-143-17      | 993203        |
| 2311-125-13      | 011035        | 3551-148-16      | 345931        | 9554-140-21      | 993215        |
| 2311-130-11      | 012036        | 3551-148-17      | 345962        | 9554-140-23      | 993216        |
| 2411-130-19      | 011004        | 3551-148-19      | 345933        | 9554-141-19      | 993214        |
| 2411-130-21      | 011005        | 3552-145-21      | 345964        | 9554-143-17      | 993213        |
| 2411-133-17      | 011003        | 3552-148-17      | 345962        | 9571-148-23      | 993026        |
| 2411-135-15      | 011002        | 3552-148-19      | 345963        | 9571-150-21      | 993025        |
| 2411-138-13      | 011001        | 3553-140-23      | 435935        | 9571-153-19      | 993024        |
| 2411-140-11      | 012047        | 3553-140-25      | 435936        | 9571-155-17      | 993023        |
| 2431-130-21      | 335033        | 4111-093-09      | 062016        | 9572-148-23      | 993036        |
| 2441-133-17      | 335031        | 4231-100-15      | 305530        | 9572-150-21      | 993035        |
| 2441-133-19      | 335032        | 4231-101-13      | 305529        | 9572-153-19      | 993034        |
| 2441-138-15      | 335030        | 4311-116-12      | 032043        | 9572-155-17      | 993033        |

# QUICKSILVER® - MICHIGAN WHEEL CROSS REFERENCE

| Quicksilver®<br>Part # | MWM<br>Part # | Quicksilver®<br>Part # | MWM<br>Part # | Quicksilver®<br>Part # | MWM<br>Part # |
|------------------------|---------------|------------------------|---------------|------------------------|---------------|
| 48-33480A1             | 032135        | QA2106R                | 031048        | QA3150R                | 012011        |
| 48-47670A10            | 032020        | QA2124R                | 032056        | QA3152R                | 012013        |
| 48-47922A10            | 032021        | QA2128R                | 032052        | QA3168R                | 012111        |
| 48-819335A40           | 072132        | QA2130R                | 032050        | QA3190R                | 012032        |
| 48-819336A40           | 072131        | QA2158R                | 142017        | QA3808R                | 022002        |
| 48-819337A45           | 072014        | QA2182X                | 992202        | QA3812R                | 022003        |
| 48-86962A4             | 032136        | QA2184X                | 992203        | QA3828X                | 992109        |
| 48-FP669-3             | 071035        | QA2186X                | 992204        | QA3832X                | 992112        |
| 48-FP685-3             | 071036        | QA2202X                | 992116        | QA3902R                | 102003        |
| 48-FP685-3             | 072128        | QA2204X                | 992115        | QA3906R                | 102004        |
| 48-FP686-4             | 992115        | QA2206X                | 992114        | QA3914R                | 102005        |
| 48-FP692-3             | 072127        | QA2208X                | 992113        | QS5004X                | 993023        |
| 48-FP743-2             | 992112        | QA2226R                | 032044        | QS5005X                | 993033        |
| QA1912X                | 992003        | QA2230R                | 032042        | QS5006X                | 993024        |
| QA1916X                | 992004        | QA2232R                | 032041        | QS5007X                | 993034        |
| QA1918X                | 992005        | QA2234R                | 032040        | QS5008X                | 993025        |
| QA1920X                | 992006        | QA2242R                | 992501        | QS5009X                | 993035        |
| QA2008X                | 992002        | QA2248R                | 992503        | QS5010X                | 993026        |
| QA2028X                | 992109        | QA2252R                | 992504        | QS5011X                | 993036        |
| QA2032X                | 992112        | QA2254R                | 992505        | QS5050X                | 993042        |
| QA2034X                | 992113        | QA2828X                | 992109        | QS5052X                | 993043        |
| QA2036X                | 992114        | QA2832X                | 992112        | QS5053X                | 993053        |
| QA2038X                | 992115        | QA3080R                | 011034        | QS5054X                | 993044        |
| QA2040X                | 992116        | QA3080R                | 012036        | QS5055X                | 993054        |
| QA2062X                | 992601        | QA3082R                | 011035        | QS5056X                | 993045        |
| QA2064X                | 992602        | QA3082R                | 012037        | QS5057X                | 993055        |
| QA2070X                | 992404        | QA3084R                | 011027        | QS5058X                | 993046        |
| QA2074X                | 992405        | QA3088R                | 011028        | QS5059X                | 993056        |
| QA2078X                | 992406        | QA3114R                | 012055        | QS5164X                | 993405        |
| QA2080X                | 992407        | QA3118R                | 012056        | QS5166X                | 993406        |
| QA2084X                | 992408        | QA3122R                | 012057        | QS5168X                | 993407        |
| QA2102R                | 031049        | QA3136R                | 012016        | QS5170X                | 993408        |

# MICHIGAN WHEEL XHS® / XHS II™ CROSS REFERENCE

## XHS® / XHS II® HUB SYSTEM CROSS REFERENCE TO MERCURY® FLO-TORQ® HUB SYSTEM

| Mercury® Flo-Torq® | XHS II® Hub Kit | Mercury® Flo-Torq® | XHS II® Hub Kit |
|--------------------|-----------------|--------------------|-----------------|
| 835257A1.....      | 202             | 835257Q1.....      | 202             |
| 835265A1.....      | 200             | 835266Q1.....      | 206             |
| 835266A1.....      | 206             | 835267Q1.....      | 201             |
| 835267A1.....      | 201             | 835270Q1.....      | 205             |
| 835270A1.....      | 205             | 835271Q1.....      | 203             |
| 835271A1.....      | 203             | 835272Q1.....      | 208             |
| 835272A1.....      | 208             | 835277Q1.....      | 202             |
| 835277A1.....      | 202             | 835279Q2.....      | 207             |
| 835278A1.....      | 207             | 835278Q1.....      | 207             |
| 835279A1.....      | 207             | 835281Q1.....      | 204             |
| 835281A1.....      | 204             | 835282Q1.....      | 210             |
| 835282A1.....      | 210             | 835283Q1.....      | 225             |
| 835284A1.....      | 209             | 835283Q2.....      | 226             |
| 835257K1.....      | 202             | 835284Q1.....      | 209             |

## XHS® / XHS II® HUB SYSTEM CROSS REFERENCE TO SOLAS® RUBEX® (RBX®) HUB SYSTEM

| Solas® Rubex® | XHS II® Hub Kit | Solas® Rubex® | XHS II® Hub Kit |
|---------------|-----------------|---------------|-----------------|
| RBX-100.....  | 200             | RBX-107.....  | 207             |
| RBX-101.....  | 201             | RBX-108.....  | 208             |
| RBX-102.....  | 202             | RBX-109.....  | 209             |
| RBX-103.....  | 203             | RBX-110.....  | 210             |
| RBX-104.....  | 204             | RBX-125.....  | 225             |
| RBX-105.....  | 205             | RBX-126.....  | 226             |
| RBX-106.....  | 206             |               |                 |

## XHS® / XHS II® HUB SYSTEM CROSS REFERENCE TO TURNING POINT® MASTERGUARD®/MASTERTORQUE® HUB SYSTEM

(MASTERGUARD® / MASTERTORQUE® HUB SYSTEMS NOT COMPATIBLE WITH MICHIGAN WHEEL XHS® PROPELLERS)

| Manufacturer/<br>Horsepower Range   | Turning Point®<br>MasterGuard® | XHS®<br>Hub Kit | Manufacturer/<br>Horsepower Range   | Turning Point®<br>MasterTorque® | XHS II®<br>Hub Kit |
|---|--------------------------------|-----------------|---|---------------------------------|--------------------|
| Evinrude®/Johnson®<br>20-35 HP • 3-1/4" Gearcase (Thru Hub & 14 Tooth)            | 22<br>1120 0200                | 118             | Evinrude®/Johnson®<br>90, 115, & 140 HP (4-Stroke) • 4-1/4" Gearcase (15 Tooth)       | 501 / 509<br>1150 0100/0900     | See Note 4         |
| Force®<br>25 HP • 3-1/4" Gearcase (Thru Hub & 10 Tooth)                           | 21<br>1120 0100                | 120             | Force®<br>75-150 HP • Using Mercury® 4-1/4" Gearcase (15 Tooth)                       | 501<br>1150 0100                | 202                |
| Mercury®/Mariner®<br>9.9-25 HP (Thru Hub & 10 Tooth)                              | 21<br>1120 0100                | 120             | Honda®<br>75-130 HP • 4-1/4" Gearcase (Thru Hub & 15 Tooth)                           | 501 / 507<br>1150 0100/0700     | See Note 3         |
| Honda®<br>25-30 HP • 3-1/4" Gearcase (Thru Hub & 10 Tooth)                        | 28<br>1120 0800                | 119             | Mercury®/Mariner®<br>40-140 HP • 4-1/4" Gearcase (Thru Hub & 15 Tooth)                | 501<br>1150 0100                | 202                |
| Mercury®/Mariner®<br>25-30 HP • Mercury 3-1/4" Gearcase (Thru Hub & 10 Tooth)     | 28<br>1120 0800                | 122             | Nissan®/Tohatsu®<br>60-140 HP • 4-1/4" Gearcase (Thru Hub & 15 Tooth)                 | 505<br>1150 0500                | 209                |
| Nissan®/Tohatsu®<br>25-30 HP • 3-1/4" Gearcase (Thru Hub & 10 Tooth)              | 28<br>1120 0800                | 122             | Suzuki®<br>70-140 HP (4-Stroke) • 4-1/4" Gearcase (15 Tooth)                          | 501 / 509<br>1150 0100/0900     | See Note 4         |
| Yamaha®<br>20-30 HP • 3-1/4" Gearcase (Thru Hub & 10 Tooth)                       | 25<br>1120 0500                | 123             | Yamaha®<br>50-130 HP • 4-1/4" Gearcase (Thru Hub & 15 Tooth)                          | 500 / 505<br>1150 0000/0500     | See Note 4         |
| Evinrude®/Johnson®<br>25-30 HP (4-Stroke) • 3-1/2" Gearcase (Thru Hub & 10 Tooth) | 26<br>1120 0600                | 121             | Evinrude®/Johnson®<br>40-75 HP • Large 4-1/4" Gearcase (Thru Hub & 13 Tooth)          | 503<br>1150 0300                | See Note 5         |
| Suzuki®<br>25-30 HP • 3-1/4" Gearcase (Thru Hub & 10 Tooth)                       | 26<br>1120 0600                | 121             | OMC® - Outboard Marine<br>Model 400, Cobra • 4-1/4" Gearcase (Thru Hub & 13 Tooth)    | 503<br>1150 0300                | 206                |
| Evinrude®/Johnson®<br>40-50 HP (4-Stroke) • 3-1/4" Gearcase (Thru Hub & 13 Tooth) | 11<br>1130 0100                | 115             | Suzuki®<br>60-140 HP • 4-1/4" Gearcase (Thru Hub & 13 Tooth)                          | 506<br>1150 0600                | 210                |
| Force®<br>40-75 HP • 3-1/4" Gearcase (Thru Hub & 13 Tooth)                        | 11<br>1130 0100                | 114             | Evinrude®/Johnson®<br>90-300 HP • V6 (4-3/4") Gearcase - Includes E-Tec Engines       | 502<br>1150 0200                | See Note 2         |
| Honda®<br>35-50 HP • 3-1/4" Gearcase (Thru Hub & 13 Tooth)                        | 12<br>1130 0200                | 113             | Honda®<br>135-225 HP • 4-3/4" Gearcase (Thru Hub & 15 Tooth)                          | 507<br>1150 0700                | 207                |
| Mercury®/Mariner®<br>25-70 HP • 3-1/4" Gearcase (Thru Hub & 13 Tooth)             | 11<br>1130 0100                | 114             | Mercury®/Mariner®/Mercruiser®<br>135-300 HP • V6 (4-3/4") Gearcase & Mercruiser I/O   | 501<br>1150 0100                | 202                |
| Nissan®/Tohatsu®<br>35-60 HP • 3-1/4" Gearcase (Thru Hub & 13 Tooth)              | 13<br>1130 0300                | 116             | OMC® - Outboard Marine<br>Model 800, King Cobra®, Cobra®, Sea Drive • 4-3/4" Gearcase | 502<br>1150 0200                | See Note 2         |
| Suzuki®<br>35-65 HP • 3-1/4" Gearcase (Thru Hub & 13 Tooth)                       | 11<br>1130 0100                | 115             | Suzuki®<br>150-300 HP • 4-3/4" Gearcase (Thru Hub & 15 Tooth)                         | 507<br>1150 0700                | 204                |
| Yamaha®<br>30-60 HP • 3-1/4" Gearcase (Thru Hub & 13 Tooth)                       | 12<br>1130 0200                | 111             | Volvo Penta®<br>SX Cobra®, Volvo Penta SX® • 4-3/4" Gearcase (19 Tooth)               | 504<br>1150 0400                | 205                |
| Evinrude®/Johnson®<br>40-75 HP • Small 3-3/8" Gearcase (Thru Hub & 13 Tooth)      | 12<br>1130 0200                | 111             | Yamaha®<br>150-300 HP & Yamaha® Sterndrives • 4-3/4" Gearcase                         | 505<br>1150 0500                | 203                |

Mercury® and Flo-Torq® are registered trademarks of Brunswick Corporation. Solas® and Rubex® are registered trademarks of Solas Science & Engineering Co., Ltd. Turning Point®, MasterGuard®, and MasterTorque® are trademarks of Turning Point Propellers, Inc.

# MICHIGAN WHEEL OEM CROSS REFERENCE

| Original Equipment Manufacturer<br>Part & Trade Mark |                         | Standard Hub Propeller |            |                  | XHS® / XHS II® Hub Propeller |                 |                    | XHS® / XHS II®<br>Hub Kit(s) | Catalog Page #s |                    |
|--|-------------------------|------------------------|------------|------------------|------------------------------|-----------------|--------------------|------------------------------|-----------------|--------------------|
|  |                         | Michigan<br>Match®     | Ballistic® | Ballistic®<br>XL | Vortex®<br>XHS               | Apollo®<br>Std. | Apollo®<br>Lg. Dia |                              |                 | Apollo®<br>4-Blade |
| <b>BRP®, EVINRUDE®, JOHNSON®, OMC®</b>               |                         |                        |            |                  |                              |                 |                    |                              |                 |                    |
| 174811   | VIPER™ (LH)             |                        | 345063     |                  | 993054                       | 993214          | See Note 2         | 9,37                         |                 |                    |
| 174812   | VIPER™ (LH)             |                        | 345064     |                  | 993055                       | 993035          | 993215             | See Note 2                   | 9,37            |                    |
| 174813   | VIPER™ (LH)             |                        | 345065     |                  | 993056                       | 993036          | 993216             | See Note 2                   | 9,37            |                    |
| 174814   | VIPER™                  | .011008                | 345033     |                  | 992004                       | 993044          | 993024             | 993204                       | See Note 2      | 9,37               |
| 174815   | VIPER™                  | .011009                | 345034     |                  | 992005                       | 993045          | 993025             | 993205                       | See Note 2      | 9,37               |
| 174816   | VIPER™                  | .011010*               | 345035     |                  | 992006                       | 993046          | 993026             | 993206                       | See Note 2      | 9,37               |
| 174889   | VIPER™                  | .011007                | 345032     |                  | 992003                       | 993043          | 993023             | 993203                       | See Note 2      | 9,37               |
| 174890   | VIPER™ (LH)             |                        | 345062     |                  | 993053                       | 993033          | 993213             | See Note 2                   | 9,37            |                    |
| 174926   | SST II®                 | .011006                | 345031     |                  | 992002                       | 993042          |                    | See Note 2                   | 9,37            |                    |
| 174927   | SST II® (LH)            |                        |            |                  | 993052                       |                 |                    | See Note 2                   | 9,37            |                    |
| 174950   |                         | .012111                |            |                  |                              |                 |                    |                              | 2               |                    |
| 175190   |                         | .012055                |            |                  | 992503                       |                 | 118                |                              | 4               |                    |
| 175191   |                         | .012056                | 305029     |                  | 992505                       |                 | 118                |                              | 4               |                    |
| 175738   | Renegade™ Bass          |                        |            | 435036           |                              |                 |                    |                              | 9               |                    |
| 175739   | Renegade™ Bass          |                        |            | 435037           |                              |                 |                    |                              | 9               |                    |
| 176058   | Renegade™ Bass          |                        |            | 435035           |                              |                 |                    |                              | 9               |                    |
| 176196   | Renegade™ Bass          | .011005                | 335033     | 335034           | 992116                       | 993146          |                    | See Note 5                   | 6,7,36          |                    |
| 176214   |                         | .011024                | 335031     |                  | 992114                       | 993144          |                    | See Note 5                   | 6,7,36          |                    |
| 176215   |                         | .011025                | 335032     |                  | 992115                       | 993145          |                    | See Note 5                   | 6,7,36          |                    |
| 176216   |                         | .011005                | 335033     |                  | 992116                       | 993146          |                    | See Note 5                   | 6,7,36          |                    |
| 176421   |                         | .011027                | 325030     |                  | 992312                       |                 | 111                |                              | 5               |                    |
| 176422   |                         | .011028                | 325031     |                  | 992303                       |                 | 111                |                              | 5               |                    |
| 176424   |                         |                        |            |                  | 992504                       |                 | 118                |                              | 4               |                    |
| 176425   |                         |                        |            |                  | 992506                       |                 | 118                |                              | 4               |                    |
| 176571   | SST II®                 | .011002                | 335030     |                  | 992113                       | 993143          |                    | See Note 5                   | 6,7,36          |                    |
| 176572   | SST II®                 | .011003                | 335031     |                  | 992114                       | 993144          |                    | See Note 5                   | 6,7,36          |                    |
| 176573   | SST II®                 | .011004                | 335032     |                  | 992115                       | 993145          |                    | See Note 5                   | 6,7,36          |                    |
| 176574   | SST II®                 | .011005                | 335033     | 335034           | 992116                       | 993146          |                    | See Note 5                   | 6,7,36          |                    |
| 176575   | Renegade™ O.S.          | .011007                | 345032     |                  | 992003                       | 993043          | 993023             | 993203                       | See Note 2      | 9,37               |
| 176576   | Renegade™ O.S.          | .011008                | 345033     |                  | 992004                       | 993044          | 993024             | 993204                       | See Note 2      | 9,37               |
| 176577   | Renegade™ O.S.          | .011009                | 345034     |                  | 992005                       | 993045          | 993025             | 993205                       | See Note 2      | 9,37               |
| 176578   | Renegade™ O.S. (LH)     |                        | 345062     |                  | 993053                       | 993033          | 993213             | See Note 2                   | 9,37            |                    |
| 176579   | Renegade™ O.S. (LH)     |                        | 345063     |                  | 993054                       | 993034          | 993214             | See Note 2                   | 9,37            |                    |
| 176580   | Renegade™ O.S. (LH)     |                        | 345064     |                  | 993055                       | 993035          | 993215             | See Note 2                   | 9,37            |                    |
| 176615   | Swept-Blade™            | .011007                | 345032     |                  | 992003                       | 993043          | 993023             | 993203                       | See Note 2      | 9,37               |
| 176616   | Swept-Blade™ (LH)       |                        | 345062     |                  | 993053                       | 993033          | 993213             | See Note 2                   | 9,37            |                    |
| 176617   | Swept-Blade™            | .011008                | 345033     |                  | 992004                       | 993044          | 993024             | 993204                       | See Note 2      | 9,37               |
| 176618   | Swept-Blade™ (LH)       |                        | 345063     |                  | 993054                       | 993034          | 993214             | See Note 2                   | 9,37            |                    |
| 176619   | Swept-Blade™ (LH)       | .011009                | 345034     |                  | 992005                       | 993045          | 993025             | 993205                       | See Note 2      | 9,37               |
| 176620   | Swept-Blade™ (LH)       |                        | 345064     |                  | 993055                       | 993035          | 993215             | See Note 2                   | 9,37            |                    |
| 176623   | VIPER™                  | .011003                | 335031     |                  | 992114                       | 993144          |                    | See Note 5                   | 6,7,36          |                    |
| 176624   | VIPER™                  | .011004                | 335032     |                  | 992115                       | 993145          |                    | See Note 5                   | 6,7,36          |                    |
| 176625   | VIPER™                  | .011005                | 335033     |                  | 992116                       | 993146          |                    | See Note 5                   | 6,7,36          |                    |
| 176626   | VIPER™                  | .011007                | 345032     |                  | 992003                       | 993043          | 993023             | 993203                       | See Note 2      | 9,37               |
| 176627   | VIPER™                  | .011008                | 345033     |                  | 992004                       | 993044          | 993024             | 993204                       | See Note 2      | 9,37               |
| 176628   | VIPER™                  | .011009                | 345034     |                  | 992005                       | 993045          | 993025             | 993205                       | See Note 2      | 9,37               |
| 176629   | VIPER™ (LH)             |                        | 345062     |                  | 993053                       | 993033          | 993213             | See Note 2                   | 9,37            |                    |
| 176630   | VIPER™ (LH)             |                        | 345063     |                  | 993054                       | 993034          | 993214             | See Note 2                   | 9,37            |                    |
| 176902   | VIPER™ (LH)             |                        | 345064     |                  | 993055                       | 993035          | 993215             | See Note 2                   | 9,37            |                    |
| 176969   | SST®                    | .011008                | 345033     |                  | 992004                       | 993044          | 993024             | 993204                       | See Note 2      | 9,37               |
| 176970   | SST®                    | .011008                | 345033     |                  | 992004                       | 993044          | 993024             | 993204                       | See Note 2      | 9,37               |
| 176971   | SST®                    | .011009                | 345034     |                  | 992005                       | 993045          | 993025             | 993205                       | See Note 2      | 9,37               |
| 176973   | SST® (LH)               |                        |            |                  | 993053                       | 993033          | 993213             | See Note 2                   | 9,37            |                    |
| 176999   | Renegade™ O.S.          | .011010*               | 345035     |                  | 992006                       | 993046          | 993026             | 993206                       | See Note 2      | 9,37               |
| 177000   | Renegade™ O.S. (LH)     |                        |            |                  | 993056                       | 993036          | 993216             | See Note 2                   | 9,37            |                    |
| 177034   | SST®                    | .011002                | 335030     |                  | 992113                       | 993143          |                    | See Note 5                   | 6,7,36          |                    |
| 177035   | SST®                    | .011003                | 335031     |                  | 992114                       | 993144          |                    | See Note 5                   | 6,7,36          |                    |
| 177036   | SST®                    | .011004                | 335032     |                  | 992115                       | 993145          |                    | See Note 5                   | 6,7,36          |                    |
| 177042   | VIPER™                  | .011002                | 335030     |                  | 992113                       | 993143          |                    | See Note 5                   | 6,7,36          |                    |
| 177128   | Renegade™ Bass TBX™ (4) |                        | 435035     |                  |                              |                 |                    |                              | 9               |                    |
| 177129   | Renegade™ Bass TBX™ (4) |                        | 435036     |                  |                              |                 |                    |                              | 9               |                    |
| 177130   | Renegade™ Bass TBX™ (4) |                        | 435037     |                  |                              |                 |                    |                              | 9               |                    |
| 177131   |                         | .011024                | 335031     |                  | 992114                       | 993144          |                    | See Note 5                   | 6,7,36          |                    |
| 177134   |                         | .011007                | 345032     |                  | 992003                       | 993043          | 993023             | 993203                       | See Note 2      | 9,37               |
| 177135   |                         | .011008                | 345033     |                  | 992004                       | 993044          | 993024             | 993204                       | See Note 2      | 9,37               |
| 177136   |                         | .011009                | 345034     |                  | 992005                       | 993045          | 993025             | 993205                       | See Note 2      | 9,37               |

\* Indicates limited quantities.

# MICHIGAN WHEEL OEM CROSS REFERENCE

| Original Equipment Manufacturer<br>Part & Trade Mark | Standard Hub Propeller |            |                  | XHS® / XHS II® Hub Propeller |                 |                    | XHS® / XHS II®<br>Hub Kit(s) | Catalog Page #s         |
|--|------------------------|------------|------------------|------------------------------|-----------------|--------------------|------------------------------|-------------------------|
|  | Michigan<br>Match®     | Ballistic® | Ballistic®<br>XL | Vortex®<br>XHS               | Apollo®<br>Std. | Apollo®<br>Lg. Dia |                              |                         |
| <b>BRP®, EVINRUDE®, JOHNSON®, OMC® (Continued)</b>   |                        |            |                  |                              |                 |                    |                              |                         |
| 177137   | 011010*                | 345035     |                  | 992006                       | 993046          | 993026             | 993206                       | See Note 2 ..... 9,37   |
| 177139   | 011025                 | 335032     |                  | 992115                       | 993145          |                    |                              | See Note 5 ..... 6,7,36 |
| 177140   |                        | 335033     |                  | 992116                       | 993145          |                    |                              | See Note 5 ..... 6,7,36 |
| 177151   | 011002                 | 335030     |                  | 992113                       | 993143          |                    |                              | See Note 5 ..... 6,7,36 |
| 177153   | 012037                 |            |                  | 992311                       |                 |                    | 111                          | ..... 5                 |
| 177159   | 012111                 |            |                  |                              |                 |                    |                              | ..... 3                 |
| 177187   | 012057                 |            |                  |                              |                 |                    |                              | ..... 4                 |
| 177258   | VIPER™                 | 011002     | 335030           | 992113                       | 993143          |                    |                              | See Note 5 ..... 6      |
| 177259   | VIPER™                 | 011003     | 335031           | 992114                       | 993144          |                    |                              | See Note 5 ..... 6      |
| 177264   | Raker II®              |            | 345041           |                              |                 |                    |                              | ..... 9,37              |
| 177265   | Raker II®              |            | 345037           |                              |                 |                    |                              | ..... 9,37              |
| 177266   | Raker II®              |            | 345038           |                              |                 |                    |                              | ..... 9,37              |
| 178811   | VIPER™ (LH)            |            |                  |                              | 993054          | 993034             | 993214                       | See Note 2 ..... 9,37   |
| 178814   | VIPER™                 | 011008     | 345033           | 992004                       | 993044          | 993024             | 993204                       | See Note 2 ..... 9,37   |
| 277212   |                        | 012011     |                  |                              |                 |                    |                              | ..... 3                 |
| 277443   |                        | 012011     |                  |                              |                 |                    |                              | ..... 3                 |
| 277580   |                        | 012024     |                  |                              |                 |                    |                              | ..... 4                 |
| 277581   |                        | 012024     |                  |                              |                 |                    |                              | ..... 4                 |
| 277583   |                        | 012011     |                  |                              |                 |                    |                              | ..... 3                 |
| 277599   |                        | 012011     |                  |                              |                 |                    |                              | ..... 3                 |
| 277759   |                        | 012008     |                  |                              |                 |                    |                              | ..... 2                 |
| 375605   |                        | 012109     |                  |                              |                 |                    |                              | ..... 3                 |
| 376506   |                        | 012011     |                  |                              |                 |                    |                              | ..... 3                 |
| 376732   |                        | 012024     |                  |                              |                 |                    |                              | ..... 4                 |
| 376735   |                        | 012109     |                  |                              |                 |                    |                              | ..... 3                 |
| 376737   |                        | 012011     |                  |                              |                 |                    |                              | ..... 3                 |
| 376805   |                        | 012011     |                  |                              |                 |                    |                              | ..... 3                 |
| 376841   |                        | 012109     |                  |                              |                 |                    |                              | ..... 3                 |
| 377410   |                        | 012023     |                  |                              |                 |                    |                              | ..... 4                 |
| 377635   |                        | 012007     |                  |                              |                 |                    |                              | ..... 2                 |
| 377636   |                        | 012011     |                  |                              |                 |                    |                              | ..... 3                 |
| 378581   |                        | 012023     |                  |                              |                 |                    |                              | ..... 4                 |
| 379717   |                        | 012109     |                  |                              |                 |                    |                              | ..... 3                 |
| 380637   |                        | 012024     |                  |                              |                 |                    |                              | ..... 4                 |
| 380958   |                        | 012005     |                  |                              |                 |                    |                              | ..... 2                 |
| 381185   |                        | 012091     |                  |                              |                 |                    |                              | ..... 37                |
| 381186   |                        | 012092     |                  |                              |                 |                    |                              | ..... 37                |
| 381801   |                        | 012011     |                  |                              |                 |                    |                              | ..... 3                 |
| 382761   |                        | 012047     |                  |                              |                 |                    |                              | ..... 6,7,36            |
| 382762   |                        | 011001     |                  | 992112                       |                 |                    |                              | See Note 5 ..... 6,7,36 |
| 382763   |                        | 011002     | 335030           | 992113                       | 993143          |                    |                              | See Note 5 ..... 6,7,36 |
| 382764   |                        | 011003     | 335031           | 992114                       | 993144          |                    |                              | See Note 5 ..... 6,7,36 |
| 382765   |                        | 011004     | 335032           | 992115                       | 993145          |                    |                              | See Note 5 ..... 6,7,36 |
| 382766   |                        | 011005     | 335033           | 992116                       | 993146          |                    |                              | See Note 5 ..... 6,7,36 |
| 382768   |                        | 011005     | 335033           | 992116                       | 993146          |                    |                              | See Note 5 ..... 6,7,36 |
| 383315   |                        | 012008     |                  |                              |                 |                    |                              | ..... 2                 |
| 383629   |                        | 012011     |                  |                              |                 |                    |                              | ..... 3                 |
| 384139   | SST®                   | 011003     | 335031           | 992114                       | 993144          |                    |                              | See Note 5 ..... 6,7,36 |
| 384140   | SST®                   | 011005     | 335033           | 992116                       | 993146          |                    |                              | See Note 5 ..... 6,7,36 |
| 384141   | SST®                   | 011005     | 335033           | 992116                       | 993146          |                    |                              | See Note 5 ..... 6,7,36 |
| 384142   | SST®                   | 011004     | 335032           | 992115                       | 993145          |                    |                              | See Note 5 ..... 6,7,36 |
| 384144   | SST®                   | 011002     | 335030           | 992113                       | 993143          |                    |                              | See Note 5 ..... 6,7,36 |
| 384702   | SST®                   | 011005     | 335033           | 992116                       | 993146          |                    |                              | See Note 5 ..... 6,7,36 |
| 385319   |                        | 012005     |                  |                              |                 |                    |                              | ..... 2                 |
| 385940   | SST®                   | 012008     |                  |                              |                 |                    |                              | ..... 2                 |
| 385955   |                        | 012023     |                  |                              |                 |                    |                              | ..... 4                 |
| 386118   |                        | 012111     |                  |                              |                 |                    |                              | ..... 3                 |
| 386317   |                        | 012054     |                  | 992501                       |                 |                    | 118                          | ..... 4                 |
| 386637   |                        | 012055     |                  | 992503                       |                 |                    | 118                          | ..... 4                 |
| 986786   |                        | 011027     | 325030           | 992311                       |                 |                    | 111                          | ..... 5                 |
| 386841   |                        | 011028     |                  | 992312                       |                 |                    | 111                          | ..... 5                 |
| 386907   |                        | 012036     |                  |                              |                 |                    |                              | ..... 5                 |
| 386909   |                        | 012037     |                  | 992301                       |                 |                    | 111                          | ..... 5                 |
| 386933   |                        | 012056     |                  | 992505                       |                 |                    | 118                          | ..... 4                 |
| 386955   |                        | 012005     |                  |                              |                 |                    |                              | ..... 2                 |
| 386980   | SST®                   | 011028     | 325031           | 992303                       |                 |                    | 111                          | ..... 5                 |

\* Indicates limited quantities.



# MICHIGAN WHEEL OEM CROSS REFERENCE

| Original Equipment Manufacturer<br>Part & Trade Mark |              | Standard Hub Propeller |            |                  | XHS® / XHS II® Hub Propeller |                 |                    | XHS® / XHS II®<br>Hub Kit(s) | Catalog Page #s |
|--|--------------|------------------------|------------|------------------|------------------------------|-----------------|--------------------|------------------------------|-----------------|
|  |              | Michigan<br>Match®     | Ballistic® | Ballistic®<br>XL | Vortex®<br>XHS               | Apollo®<br>Std. | Apollo®<br>Lg. Dia |                              |                 |
| <b>BRP®, EVINRUDE®, JOHNSON®, OMC® (Continued)</b>   |              |                        |            |                  |                              |                 |                    |                              |                 |
| 386981   | SST®         | .011027                | 325030     |                  | 992312                       |                 |                    | 111                          | 5               |
| 386982   | SST®         | .011035                |            |                  | 992311                       |                 |                    | 111                          | 5               |
| 387158   |              | .011016                |            |                  |                              |                 |                    |                              | 9,37            |
| 387159   |              | .011006                | 345031     |                  | 992002                       | 993042          |                    | See Note 2                   | 9,37            |
| 387160   |              | .011007                | 345032     |                  | 992003                       | 993043          | 993023             | 993203                       | See Note 2      |
| 387161   |              | .011008                | 345033     |                  | 992004                       | 993044          | 993024             | 993204                       | See Note 2      |
| 387162   |              | .011009                | 345034     |                  | 992005                       | 993045          | 993025             | 993205                       | See Note 2      |
| 387163   |              | .011010*               | 345035     |                  | 992006                       | 993046          | 993026             | 993206                       | See Note 2      |
| 387334   |              | .012008                |            |                  |                              |                 |                    |                              | 2               |
| 387519   | SST®         | .011008                | 345033     |                  | 992004                       | 993044          | 993024             | 993204                       | See Note 2      |
| 387520   | SST®         | .011009                | 345034     |                  | 992005                       | 993045          | 993025             | 993205                       | See Note 2      |
| 387636   |              | .012056                |            |                  |                              |                 |                    |                              | 4               |
| 388088   |              | .012013                |            |                  |                              |                 |                    |                              | 3               |
| 388294   |              | .012102                |            |                  |                              |                 |                    |                              | 3               |
| 388883   |              | .012016                |            |                  |                              |                 |                    |                              | 3               |
| 389019   | SST II®      | .011010*               | 345035     |                  |                              | 993046          | 993026             | 993206                       | See Note 2      |
| 389068   |              | .012021                |            |                  |                              |                 |                    |                              | 3               |
| 389069   |              | .012015                |            |                  |                              |                 |                    |                              | 3               |
| 389510   | SST II®      | .011004                | 335032     |                  | 992115                       | 993145          |                    |                              | See Note 5      |
| 389512   | SST II®      | .011005                | 335033     |                  | 992116                       | 993146          |                    |                              | See Note 5      |
| 389619   |              | .012015                |            |                  |                              |                 |                    |                              | 3               |
| 389788   |              | .011005                | 335033     | 335034           | 992116                       | 993146          |                    |                              | See Note 5      |
| 389855   |              | .012023                |            |                  |                              |                 |                    |                              | 4               |
| 389923   | SST II®      | .011009                | 345034     |                  | 992005                       | 993045          | 993025             | 993205                       | See Note 2      |
| 389924   | SST II®      | .011008                | 345033     |                  | 992004                       | 993044          | 993024             | 993204                       | See Note 2      |
| 389925   | SST®         | .011007                | 345032     |                  | 992003                       | 993043          | 993023             | 993203                       | See Note 2      |
| 389944   |              | .012030                |            |                  |                              |                 |                    |                              | 3               |
| 389948   | SST II®      | .011003                | 335031     |                  | 992114                       | 993144          |                    |                              | See Note 5      |
| 389949   | SST II®      | .011002                | 335030     |                  | 992113                       | 993143          |                    |                              | See Note 5      |
| 390113   | SST®         | .011004                | 335032     |                  | 992115                       | 993145          |                    |                              | See Note 5      |
| 390114   | SST®         | .011003                | 335031     |                  | 992114                       | 993144          |                    |                              | See Note 5      |
| 390237   |              | .012032                |            |                  |                              |                 |                    |                              | 2               |
| 390380   |              | .012057                | 305030     |                  |                              |                 |                    |                              | 4               |
| 390725   | SST®         |                        | 345036     |                  |                              |                 |                    |                              | 9,37            |
| 390729   | SST®         |                        | 305029     |                  |                              |                 |                    |                              | 4               |
| 390730   | SST®         |                        | 305030     |                  |                              |                 |                    |                              | 4               |
| 390821   | SST II® (LH) |                        | 345063     |                  |                              | 993054          | 993034             | 993214                       | See Note 2      |
| 390822   | SST II® (LH) |                        | 345064     |                  |                              | 993055          | 993035             | 993215                       | See Note 2      |
| 390823   | SST II® (LH) |                        | 345065     |                  |                              | 993056          | 993036             | 993216                       | See Note 2      |
| 390833   |              | .012024                |            |                  |                              |                 |                    |                              | 4               |
| 390849   | SST®         | .011035                |            |                  | 992311                       |                 |                    | 111                          | 5               |
| 390850   | SST®         | .011027                | 325030     |                  | 992312                       |                 |                    | 111                          | 5               |
| 390851   | SST®         | .011028                | 325031     |                  | 992303                       |                 |                    | 111                          | 5               |
| 390896   |              | .011004                | 335032     |                  | 992115                       | 993145          |                    |                              | See Note 5      |
| 391198   |              | .011002                | 335030     |                  | 992113                       | 993143          |                    |                              | See Note 5      |
| 391199   |              | .011003                | 335031     |                  | 992114                       | 993144          |                    |                              | See Note 5      |
| 391200   |              | .011007                | 345032     |                  | 992003                       | 993043          | 993023             | 993203                       | See Note 2      |
| 391201   |              | .011008                | 345033     |                  | 992004                       | 993044          | 993024             | 993204                       | See Note 2      |
| 391202   |              | .011009                | 345034     | 345041           | 992005                       | 993045          | 993025             | 993205                       | See Note 2      |
| 391203   |              | .011010*               | 345035     | 345037           | 992006                       | 993046          | 993026             | 993206                       | See Note 2      |
| 391290   | SST II®      | .011007                | 345032     |                  | 992003                       | 993043          | 993023             | 993203                       | See Note 2      |
| 391535   |              | .011006                | 345031     |                  | 992002                       | 993042          | 993022             |                              | See Note 2      |
| 391536   |              | .011016                |            |                  |                              |                 |                    |                              | 9,37            |
| 391668   |              | .011001                |            |                  |                              |                 |                    |                              | 6,7,36          |
| 393160   |              | .011025                |            |                  | 992115                       | 993145          |                    |                              | See Note 5      |
| 394752   | Raker®       | .011007                | 345032     |                  | 992003                       | 993043          |                    | 993203                       | See Note 2      |
| 394753   | Raker®       | .011008                | 345033     |                  | 992004                       | 993044          |                    | 993204                       | See Note 2      |
| 394754   | Raker®       | .011009                | 345034     | 345041           | 992005                       | 993045          |                    | 993205                       | See Note 2      |
| 394755   | Raker®       | .011010*               | 345035     | 345037           | 992006                       | 993046          |                    | 993206                       | See Note 2      |
| 394756   | Raker®       |                        | 345036     | 345038           |                              |                 |                    |                              | 9,37            |
| 394758   | Raker®       | .011003                | 335031     |                  | 992114                       | 993144          |                    |                              | See Note 5      |
| 394759   | Raker®       | .011004                | 335032     |                  | 992115                       | 993145          |                    |                              | See Note 5      |
| 394760   | Raker®       | .011005                | 335033     | 335034           | 992115                       | 993146          |                    |                              | See Note 5      |
| 394761   | Raker®       |                        |            | 335035           |                              |                 |                    |                              | 7               |
| 398126   |              | .012112                |            |                  |                              |                 |                    |                              | 2               |
| 398502   | Raker® (LH)  |                        | 345063     |                  |                              | 993054          |                    | 993214                       | See Note 2      |

\* Indicates limited quantities.

# MICHIGAN WHEEL OEM CROSS REFERENCE

| Original Equipment Manufacturer<br>Part & Trade Mark | Standard Hub Propeller |            |               | XHS® / XHS II® Hub Propeller |              |                 | XHS® / XHS II®<br>Hub Kit(s) | Catalog Page #s |                 |
|--|------------------------|------------|---------------|------------------------------|--------------|-----------------|------------------------------|-----------------|-----------------|
|  | Michigan Match®        | Ballistic® | Ballistic® XL | Vortex® XHS                  | Apollo® Std. | Apollo® Lg. Dia |                              |                 | Apollo® 4-Blade |
| <b>BRP®, EVINRUDE®, JOHNSON®, OMC® (Continued)</b>   |                        |            |               |                              |              |                 |                              |                 |                 |
| 398503   | Raker® (LH)            |            | 345064        |                              | 993055       |                 | 993215                       | See Note 2      | 9,37            |
| 398504   | Raker® (LH)            |            |               |                              | 993056       |                 | 993216                       | See Note 2      | 9,37            |
| 431717   | Shooter®               |            |               | 435035                       |              |                 |                              |                 | 9               |
| 431718   | Shooter®               |            |               | 435036                       |              |                 |                              |                 | 9               |
| 431930   | SST II® (LH)           |            | 345062        |                              | 993053       |                 | 993213                       | See Note 2      | 9,37            |
| 591920   |                        |            | .012024       |                              |              |                 |                              |                 | 4               |
| 591925   |                        |            | .012011       |                              |              |                 |                              |                 | 3               |
| 592038   |                        |            | .012011       |                              |              |                 |                              |                 | 3               |
| 592959   |                        |            | .012011       |                              |              |                 |                              |                 | 3               |
| 763301   |                        |            | .012047       |                              |              |                 |                              |                 | 6,7,36          |
| 763302   |                        |            | .011001       |                              | 992112       |                 |                              | See Note 5      | 6,7,36          |
| 763304   |                        |            |               | 346031                       | 992002       | 993042          | 993022                       | 205             | 38              |
| 763305   |                        |            |               |                              | 993052       | 993032          |                              | 205             | 38              |
| 763306   |                        |            | 161002        | 346032                       | 992003       | 993043          | 993023                       | 993203          | 205             |
| 763307   |                        |            |               | 346062                       |              | 993053          | 993033                       | 993213          | 205             |
| 763308   |                        |            | 161003        | 346033                       | 992004       | 993044          | 993024                       | 993204          | 205             |
| 763309   |                        |            |               |                              |              | 993054          | 993034                       | 993214          | 205             |
| 763310   |                        |            | 161004        | 346034                       | 992005       | 993045          | 993025                       | 993205          | 205             |
| 763311   |                        |            |               | 346064                       |              | 993055          | 993035                       | 993215          | 205             |
| 763315   |                        |            | 161001        | 346031                       | 992002       | 993042          | 993022                       |                 | 205             |
| 763316   |                        |            | 161002        | 346032                       | 992003       | 993043          | 993023                       | 993203          | 205             |
| 763317   |                        |            | 161003        | 346033                       | 992004       | 993044          | 993024                       | 993204          | 205             |
| 763318   |                        |            | 161004        | 346034                       | 992005       | 993045          | 993025                       | 993205          | 205             |
| 763319   |                        |            | 161005        | 346035                       | 992006       | 993046          | 993026                       | 993206          | 205             |
| 763453   |                        |            | .011016       |                              |              |                 |                              |                 | 9,37            |
| 763456   |                        |            | .012112       |                              |              |                 |                              |                 | 2               |
| 763459   |                        |            | .012055       |                              | 992503       |                 |                              | 118             | 4               |
| 763460   |                        |            |               |                              | 992504       |                 |                              | 118             | 4               |
| 763461   |                        |            | .012037       |                              | 992311       |                 |                              | 111             | 5               |
| 763462   |                        |            | .011028       | 325031                       | 992303       |                 |                              | 111             | 5               |
| 763463   |                        |            | .011003       | 335031                       | 992114       | 993144          |                              | See Note 5      | 6,7,36          |
| 763464   |                        |            | .011004       | 335032                       | 992115       | 993145          |                              | See Note 5      | 6,7,36          |
| 763465   |                        |            | .011005       | 335033                       | 992116       | 993146          |                              | See Note 5      | 6,7,36          |
| 763466   |                        |            | .011002       | 335030                       | 992113       | 993143          |                              | See Note 5      | 6,7,36          |
| 763467   |                        |            | .011007       | 345032                       | 992003       | 993043          | 993023                       | 993203          | See Note 2      |
| 763468   |                        |            | .011008       | 345032                       | 992004       | 993044          | 993024                       | 993204          | See Note 2      |
| 763469   |                        |            | .011009       | 345033                       | 992005       | 993045          | 993025                       | 993205          | See Note 2      |
| 763470   |                        |            |               | 345034                       | 992006       | 993046          | 993026                       | 993206          | See Note 2      |
| 763471   |                        |            | .011006       | 345031                       | 992002       | 993042          |                              | See Note 2      | 9,37            |
| 763486   |                        |            | .012057       | 305030                       |              |                 |                              |                 | 4               |
| 763487   |                        |            | .012054       |                              | 992501       |                 |                              | 118             | 4               |
| 763488   |                        |            | .012036       |                              |              |                 |                              |                 | 5               |
| 763568   | Rebel™                 |            | .011007       | 345032                       | 992003       | 993043          | 993023                       | 993203          | See Note 2      |
| 763569   | Rebel™ (LH)            |            |               | 345062                       |              | 993053          | 993033                       | 993213          | See Note 2      |
| 763570   | Rebel™                 |            | .011008       | 345033                       | 992004       | 993044          | 993024                       | 993204          | See Note 2      |
| 763571   | Rebel™ (LH)            |            |               | 345063                       |              | 993054          | 993034                       | 993214          | See Note 2      |
| 763572   | Rebel™                 |            | .011009       | 345034                       | 992005       | 993045          | 993025                       | 993205          | See Note 2      |
| 763573   | Rebel™ (LH)            |            |               | 345064                       |              | 993055          | 993035                       | 993215          | See Note 2      |
| 763574   | Rebel™ (LH)            |            | .011010*      | 345035                       | 992006       | 993046          | 993026                       | 993206          | See Note 2      |
| 763575   | Rebel™ (LH)            |            |               |                              |              | 993056          | 993036                       | 993216          | See Note 2      |
| 763583   |                        |            | .012011       |                              |              |                 |                              |                 | 3               |
| 763584   |                        |            | .012016       |                              |              |                 |                              |                 | 3               |
| 763585   |                        |            | .012021       |                              |              |                 |                              |                 | 3               |
| 763586   |                        |            | .012007       |                              |              |                 |                              |                 | 2               |
| 763587   |                        |            | .012109       |                              |              |                 |                              |                 | 3               |
| 763588   |                        |            | .012005       |                              |              |                 |                              |                 | 2               |
| 763589   |                        |            | .012015       |                              |              |                 |                              |                 | 3               |
| 763590   |                        |            | .012030       |                              |              |                 |                              |                 | 3               |
| 763912   | VIPER™ TBX™            |            |               | 345031                       |              | 993042          |                              | See Note 2      | 9,37            |
| 763913   | VIPER™ TBX™ (LH)       |            |               |                              |              | 993052          |                              | See Note 2      | 9,37            |
| 763914   | VIPER™ TBX™            |            | .011007       | 345032                       | 992003       | 993043          | 993023                       | 993203          | See Note 2      |
| 763915   | VIPER™ TBX™ (LH)       |            |               | 345062                       |              | 993053          | 993033                       | 993213          | See Note 2      |
| 763918   | VIPER™ TBX™            |            | .011008       | 345033                       | 992004       | 993044          | 993024                       | 993204          | See Note 2      |
| 763919   | VIPER™ TBX™ (LH)       |            |               | 345063                       |              | 993054          | 993034                       | 993214          | See Note 2      |
| 763922   | VIPER™ TBX™            |            | .011009       | 345034                       | 992005       | 993045          | 993025                       | 993205          | See Note 2      |
| 763923   | VIPER™ TBX™ (LH)       |            |               | 345064                       |              | 993055          | 993035                       | 993215          | See Note 2      |

\* Indicates limited quantities.

# MICHIGAN WHEEL OEM CROSS REFERENCE

| Original Equipment Manufacturer<br>Part & Trade Mark | Standard Hub Propeller |            |               | XHS® / XHS II® Hub Propeller |              |                 | XHS® / XHS II®<br>Hub Kit(s) | Catalog Page #s |
|--|------------------------|------------|---------------|------------------------------|--------------|-----------------|------------------------------|-----------------|
|  | Michigan Match®        | Ballistic® | Ballistic® XL | Vortex® XHS                  | Apollo® Std. | Apollo® Lg. Dia |                              |                 |

**BRP®, EVINRUDE®, JOHNSON®, OMC® (Continued)**

|         |                      |          |        |         |         |         |            |            |      |
|---------|----------------------|----------|--------|---------|---------|---------|------------|------------|------|
| 763924  | VIPER™ TBX™          |          | 345041 |         |         |         |            | 9,37       |      |
| 763929  | VIPER™ 3             | .011002  | 335030 | .992113 | .993143 |         | See Note 5 | 6          |      |
| 763930  | VIPER™ 3             | .011003  | 335031 | .992114 | .993144 |         | See Note 5 | 6          |      |
| 763931  | VIPER™ 3             | .011004  | 335032 | .992115 | .993145 |         | See Note 5 | 6          |      |
| 763932  | VIPER™ 3             | .011005  | 335033 | .992116 | .993146 |         | See Note 5 | 6          |      |
| 763938  | Cyclone™ TBX™ 4      |          |        | .992202 |         | 993203  | See Note 2 | 9,37       |      |
| 763939  | Cyclone™ TBX™ 4 (LH) |          |        |         |         | 993213  | See Note 2 | 9,37       |      |
| 763940  | Cyclone™ TBX™ 4      |          |        | .992203 |         | 993204  | See Note 2 | 9,37       |      |
| 763941  | Cyclone™ TBX™ 4 (LH) |          |        |         |         | 993214  | See Note 2 | 9,37       |      |
| 763944  | Cyclone™ TBX™ 4      |          |        | .992204 |         | 993205  | See Note 2 | 9,37       |      |
| 763945  | Cyclone™ TBX™ 4 (LH) |          |        |         |         | 993215  | See Note 2 | 9,37       |      |
| 763950  |                      | .011002  | 335030 | .992113 | .993143 |         | See Note 5 | 6          |      |
| 763951  |                      | .011003  | 335031 | .992114 | .993144 |         | See Note 5 | 6          |      |
| 763952  |                      | .011004  | 335032 | .992115 | .993145 |         | See Note 5 | 6          |      |
| 763956  | Raker®               |          | 335035 |         |         |         |            | 7          |      |
| 763962  | SST® TBX™            |          | 345031 | .992002 | .993042 |         | See Note 2 | 9,37       |      |
| 763963  | SST® TBX™ (LH)       |          |        |         | .993052 |         | See Note 2 | 9,37       |      |
| 763986  | Rebel™ TBX™          | .011007  | 345032 | .992003 | .993043 | .993023 | .993203    | See Note 2 | 9,37 |
| 763987  | Rebel™ TBX™ (LH)     |          | 345062 |         | .993053 | .993033 | .993213    | See Note 2 | 9,37 |
| 763990  | Rebel™ TBX™          | .011008  | 345033 | .992004 | .993044 | .993024 | .993204    | See Note 2 | 9,37 |
| 763991  | Rebel™ TBX™ (LH)     |          | 345063 |         | .993054 | .993034 | .993214    | See Note 2 | 9,37 |
| 763994  | Rebel™ TBX™          | .011009  | 345034 | .992005 | .993045 | .993025 | .993205    | See Note 2 | 9,37 |
| 763995  | Rebel™ TBX™ (LH)     |          | 345063 |         | .993055 | .993035 | .993215    | See Note 2 | 9,37 |
| 763998  | Rebel™ TBX™          | .011010* | 345035 | .992006 | .993046 | .993026 | .993206    | See Note 2 | 9,37 |
| 763999  | Rebel™ TBX™ (LH)     |          |        |         | .993056 | .993036 | .993216    | See Note 2 | 9,37 |
| 765181  |                      | .011001  |        | .992112 |         |         | See Note 5 | 6,7,36     |      |
| 765182  |                      |          |        | .992113 | .993143 |         | See Note 5 | 6,7,36     |      |
| 765183  |                      |          |        | .992114 | .993144 |         | See Note 5 | 6,7,36     |      |
| 765184  |                      |          |        | .992115 | .993145 |         | See Note 5 | 6,7,36     |      |
| 765185  |                      |          |        | .992116 | .993146 |         | See Note 5 | 6,7,36     |      |
| 765186  |                      |          | 345031 | .992002 | .993042 |         | See Note 2 | 9,37       |      |
| 765187  |                      | .011007  | 345032 | .992003 | .993043 | .993023 | .993203    | See Note 2 | 9,37 |
| 765188  |                      | .011008  | 345033 | .992004 | .993044 | .993024 | .993204    | See Note 3 | 9,37 |
| 765189  |                      | .011009  | 345034 | .992005 | .993045 | .993025 | .993205    | See Note 3 | 9,37 |
| 775713  |                      | .012037  |        | .992311 |         |         | 111        | 5          |      |
| 776807  |                      | .032046  |        |         |         |         |            | 5          |      |
| 776891  |                      | .011001  |        | .992112 |         |         | See Note 5 | 6,7,36     |      |
| 777021  | SST® High Luster     | .032042  | 395929 | .992605 | .993406 |         | 115        | 5          |      |
| 777022  | SST® High Luster     | .032041  |        | .992606 | .993407 |         | 115        | 5          |      |
| 777023  | SST® High Luster     | .032040  | 395930 | .992408 | .993408 |         | 115        | 5          |      |
| 777024  |                      | .061024  |        | .992114 | .993144 |         | See Note 4 | 8          |      |
| 777025  |                      | .061028  |        | .992115 | .993145 |         | See Note 4 | 8          |      |
| 777026  |                      | .061032  |        | .992116 | .993146 |         | See Note 4 | 8          |      |
| 777029  |                      |          |        |         | .993154 |         | See Note 4 | 8          |      |
| 777030  |                      |          |        |         | .993155 |         | See Note 4 | 8          |      |
| 777031  |                      |          |        |         | .993156 |         | See Note 4 | 8          |      |
| 778606  |                      | .032045  |        |         |         |         |            | 5          |      |
| 778607  |                      | .032044  |        | .992404 |         |         | 115        | 5          |      |
| 778608  |                      | .032043  |        | .992405 | .993405 |         | 115        | 5          |      |
| 778609  |                      | .032042  | 395929 | .992406 | .993406 |         | 115        | 5          |      |
| 778610  |                      | .032041  |        | .992407 | .993407 |         | 115        | 5          |      |
| 778703  |                      |          |        | .992503 |         |         | 121        | 3          |      |
| 778704  |                      |          |        | .992504 |         |         | 121        | 3          |      |
| 778705  |                      |          | 305529 | .992505 |         |         | 121        | 3          |      |
| 778706  |                      |          |        | .992506 |         |         | 121        | 3          |      |
| 778738  |                      | .061020  |        |         |         |         |            | 8          |      |
| 778739  |                      | .061024  |        |         |         |         |            | 8          |      |
| 778740  |                      | .061028  |        |         |         |         |            | 8          |      |
| 778741  |                      | .061032  |        |         |         |         |            | 8          |      |
| 778772  |                      | .012111  |        |         |         |         |            | 3          |      |
| 778774  |                      | .011027  | 325030 | .992302 |         |         | 111        | 5          |      |
| 778797  |                      | .012032  |        |         |         |         |            | 2          |      |
| 778863  |                      | .012056  | 305029 | .992505 |         |         | 118        | 4          |      |
| 5005384 |                      | .062016  |        |         |         |         |            | 2          |      |
| 5031619 |                      | .032042  | 395929 | .992406 | .993406 |         | 115        | 5          |      |
| 5031627 |                      | .032040  | 395930 | .992408 | .993408 |         | 115        | 5          |      |

\* Indicates limited quantities.

# MICHIGAN WHEEL OEM CROSS REFERENCE

| Original Equipment Manufacturer<br>Part & Trade Mark | Standard Hub Propeller |            |                  | XHS® / XHS II® Hub Propeller |                 |                    | XHS® / XHS II®<br>Hub Kit(s) | Catalog Page #s |
|--|------------------------|------------|------------------|------------------------------|-----------------|--------------------|------------------------------|-----------------|
|  | Michigan<br>Match®     | Ballistic® | Ballistic®<br>XL | Vortex®<br>XHS               | Apollo®<br>Std. | Apollo®<br>Lg. Dia |                              |                 |

## BRP®, EVINRUDE®, JOHNSON®, OMC® (Continued)

|              |         |        |  |             |        |  |                 |   |
|--------------|---------|--------|--|-------------|--------|--|-----------------|---|
| 5031628..... |         |        |  | 992409..... |        |  | 115.....        | 5 |
| 5032107..... |         |        |  | 992502..... |        |  | 121.....        | 3 |
| 5032108..... |         |        |  | 992503..... |        |  | 121.....        | 3 |
| 5032109..... |         |        |  | 992504..... |        |  | 121.....        | 3 |
| 5032110..... |         | 305529 |  | 992505..... |        |  | 121.....        | 3 |
| 5032171..... |         |        |  | 992501..... |        |  | 121.....        | 3 |
| 5033201..... | .062016 |        |  |             |        |  |                 | 2 |
| 5033322..... | .061020 | 335930 |  | 992113..... | 993143 |  | See Note 4..... | 8 |
| 5033323..... | .061024 | 335931 |  | 992114..... | 993144 |  | See Note 4..... | 8 |
| 5033324..... | .061028 | 335932 |  | 992115..... | 993145 |  | See Note 4..... | 8 |
| 5033325..... | .061032 | 335933 |  | 992116..... | 993146 |  | See Note 4..... | 8 |
| 5033327..... | .061024 | 335931 |  | 992114..... | 993144 |  | See Note 4..... | 8 |
| 5033328..... | .061028 | 335932 |  | 992115..... | 993145 |  | See Note 4..... | 8 |
| 5033329..... | .061032 | 335933 |  | 992116..... | 993146 |  | See Note 4..... | 8 |

## FORCE®, CHRYSLER, U.S. MARINE

|                  |                 |         |        |        |             |        |                 |       |
|------------------|-----------------|---------|--------|--------|-------------|--------|-----------------|-------|
| 48-16986A45..... | Vengeance.....  | .031041 | 335130 |        | 992113..... | 993143 | See Note 3..... | 12,13 |
| 48-16986A5.....  | QSS™.....       | .031041 | 335130 |        | 992113..... | 993143 | See Note 3..... | 12,13 |
| 48-16988A40..... | QSS™.....       | .031042 | 335131 |        | 992114..... | 993144 | See Note 3..... | 12,13 |
| 48-16988A45..... | Vengeance.....  | .031042 | 335131 |        | 992114..... | 993144 | See Note 3..... | 12,13 |
| 48-16990A40..... | Laser II™.....  | .031043 | 335132 |        | 992115..... | 993145 | See Note 3..... | 12,13 |
| 48-16990A45..... | Laser II™.....  | .031043 | 335132 |        | 992115..... | 993145 | See Note 3..... | 12,13 |
| 48-16992A40..... | Laser II™.....  | .031044 | 335133 | 335134 | 992116..... | 993146 | See Note 3..... | 12,13 |
| 48-16992A45..... | Laser II™.....  | .031044 | 335133 | 335134 | 992116..... | 993146 | See Note 3..... | 12,13 |
| 48-19636A10..... |                 |         |        |        | 992501..... |        | 120.....        | 10    |
| 48-19638A40..... | Black Max™..... | .031049 |        |        | 992503..... |        | 120.....        | 10    |
| 48-19639A40..... | Black Max™..... |         |        |        | 992504..... |        | 120.....        | 10    |
| 48-19640A40..... | Black Max™..... | .031048 | 305129 |        | 992505..... |        | 120.....        | 10    |
| 48-19642A40..... | Black Max™..... |         |        |        | 992506..... |        | 120.....        | 10    |
| 48-42738A10..... | Black Max™..... | .032141 |        |        |             |        |                 | 11    |
| 48-42740A10..... | Black Max™..... | .032142 |        |        |             |        |                 | 11    |
| 48-64724A1.....  |                 | .031020 |        |        |             |        |                 | 11    |
| 48-64724A4.....  |                 | .031020 |        |        |             |        |                 | 11    |
| 48-73132A4.....  |                 | .031015 |        |        |             |        |                 | 11    |
| 48-73132A40..... | Black Max™..... | .031015 |        |        |             |        |                 | 11    |
| 48-73134A4.....  | Black Max™..... | .031016 |        |        | 992405..... | 993405 | 114.....        | 11    |
| 48-73134A40..... | Black Max™..... | .031016 |        |        | 992405..... | 993405 | 114.....        | 11    |
| 48-73136A4.....  | Black Max™..... | .031017 | 395129 |        | 992406..... | 993406 | 114.....        | 11    |
| 48-73136A40..... | Black Max™..... | .031017 | 395129 |        | 992406..... | 993406 | 114.....        | 11    |
| 48-73138A4.....  | Black Max™..... | .031018 |        |        | 992407..... | 993407 | 114.....        | 11    |
| 48-73138A40..... | Black Max™..... | .031018 |        |        | 992407..... | 993407 | 114.....        | 11    |
| 48-73140A4.....  | Black Max™..... | .031019 | 395130 |        | 992408..... | 993408 | 114.....        | 11    |
| 48-73140A40..... | Black Max™..... | .031019 | 395130 |        | 992408..... | 993408 | 114.....        | 11    |
| 48-73142A40..... | Black Max™..... |         |        |        | 992409..... |        | 114.....        | 11    |
| 48-73144A4.....  | Black Max™..... | .031020 |        |        |             |        |                 | 11    |
| 48-73144A40..... | Black Max™..... | .031020 |        |        |             |        |                 | 11    |
| 48-76228A4.....  | QSS™.....       | .031017 | 395129 |        | 992406..... | 993406 | 114.....        | 11    |
| 48-76228A5.....  | Vengeance.....  | .031017 | 395129 |        | 992406..... | 993406 | 114.....        | 11    |
| 48-76230A4.....  | QSS™.....       | .031018 |        |        | 992407..... | 993407 | 114.....        | 11    |
| 48-76230A5.....  | Vengeance.....  | .031018 |        |        | 992407..... | 993407 | 114.....        | 11    |
| 48-76232A4.....  | QSS™.....       | .031019 | 395130 |        | 992408..... | 993408 | 114.....        | 11    |
| 48-76232A5.....  | Vengeance.....  | .031019 | 395130 |        | 992409..... | 993408 | 114.....        | 11    |
| 48-77338A40..... | Black Max™..... | .031054 |        |        |             |        |                 | 13    |
| 48-77338A45..... | Black Max™..... | .031054 |        |        |             |        |                 | 13    |
| 48-77338CP1..... | Pontoon.....    | .031200 |        |        |             |        |                 | 13    |
| 48-77340A40..... | Black Max™..... | .031055 |        |        | 992112..... |        | See Note 3..... | 12,13 |
| 48-77340A45..... | Black Max™..... | .031055 |        |        | 992112..... |        | See Note 3..... | 12,13 |
| 48-77338CP1..... | Pontoon.....    | .031202 |        |        |             |        |                 | 13    |
| 48-77342A40..... | Black Max™..... | .031041 | 335130 |        | 992113..... | 993143 | See Note 3..... | 12,13 |
| 48-77342A45..... | Black Max™..... | .031041 | 335130 |        | 992113..... | 993143 | See Note 3..... | 12,13 |
| 48-77344A40..... | Black Max™..... | .031042 | 335131 |        | 992114..... | 993144 | See Note 3..... | 12,13 |
| 48-77344A45..... | Black Max™..... | .031042 | 335131 |        | 992114..... | 993144 | See Note 3..... | 12,13 |
| 48-77346A40..... | Black Max™..... | .031043 | 335132 |        | 992115..... | 993145 | See Note 3..... | 12,13 |
| 48-77346A45..... | Black Max™..... | .031043 | 335132 |        | 992115..... | 993145 | See Note 3..... | 12,13 |
| 48-77348A40..... | Black Max™..... | .031044 | 335133 | 335134 | 992116..... | 993146 | See Note 3..... | 12,13 |
| 48-77348A45..... | Black Max™..... | .031044 | 335133 | 335134 | 992116..... | 993146 | See Note 3..... | 12,13 |

# MICHIGAN WHEEL OEM CROSS REFERENCE

| Original Equipment Manufacturer<br>Part & Trade Mark | Standard Hub Propeller |            |                  | XHS® / XHS II® Hub Propeller |                 |                    | XHS® / XHS II®<br>Hub Kit(s) | Catalog Page #s |
|--|------------------------|------------|------------------|------------------------------|-----------------|--------------------|------------------------------|-----------------|
|  | Michigan<br>Match®     | Ballistic® | Ballistic®<br>XL | Vortex®<br>XHS               | Apollo®<br>Std. | Apollo®<br>Lg. Dia |                              |                 |
| <b>FORCE®, CHRYSLER, U.S. MARINE (Continued)</b>     |                        |            |                  |                              |                 |                    |                              |                 |
| 48-77350A40  | Black Max™             |            | 031045*          |                              |                 |                    |                              | 13              |
| 48-77350A45  | Black Max™             |            | 031045*          |                              |                 |                    |                              | 13              |
| 48-79792A4   | QSS™                   |            | 031016           | 992405                       | 993405          |                    | 114                          | 11              |
| 48-79792A5   | Vengeance              |            | 031016           | 992405                       | 993405          |                    | 114                          | 11              |
| 48-816702A40   |                        |            | 031056           | 992405                       | 993405          |                    | 114                          | 11              |
| 48-816704A40   |                        |            | 031057           | 992406                       | 993406          |                    | 114                          | 11              |
| 48-816706A40   |                        |            | 031058           | 395129                       | 992407          | 993407             | 114                          | 11              |
| 48-819334A40   |                        |            | 072133           |                              |                 |                    |                              | 11              |
| 48-819335A40   |                        |            | 072132           |                              |                 |                    |                              | 11              |
| 48-819336A40   |                        |            | 072131           |                              |                 |                    |                              | 11              |
| 48-819337A40   |                        |            | 072014           |                              |                 |                    |                              | 10,11           |
| 48-819337A45   |                        |            | 072014           |                              |                 |                    |                              | 10,11           |
| 48-855858A5  | Vengeance              |            | 031057           | 992406                       | 993406          |                    | 114                          | 11              |
| 48-85632A40  | Black Max™             |            | 031053           | 992404                       |                 |                    | 114                          | 11              |
| 48-FP488   |                        |            | 072123           |                              |                 |                    |                              | 10              |
| 48-FP669-1   |                        |            | 071035           | 992113                       | 993143          |                    | 202                          | 12              |
| 48-FP669-2   |                        |            | 071035           | 992113                       | 993143          |                    | 202                          | 12              |
| 48-FP669-3   |                        |            | 071035           | 992113                       | 993143          |                    | 202                          | 12              |
| 48-FP685-1   |                        |            | 071036           | 992114                       | 993144          |                    | 202                          | 12              |
| 48-FP685-2   |                        |            | 071036           | 992114                       | 993144          |                    | 202                          | 12              |
| 48-FP685-3   |                        |            | 071036           | 992114                       | 993144          |                    | 202                          | 12              |
| 48-FP686-1   |                        |            |                  | 992115                       | 993145          |                    | 202                          | 12              |
| 48-FP686-3   |                        |            |                  | 992115                       | 993145          |                    | 202                          | 12              |
| 48-FP686-4   |                        |            |                  | 992115                       | 993145          |                    | 202                          | 12              |
| 48-FP692-1   |                        |            | 072127           | 992113                       | 993143          |                    | 202                          | 12              |
| 48-FP692-2   |                        |            | 072127           | 992113                       | 993143          |                    | 202                          | 12              |
| 48-FP692-3   |                        |            | 072127           | 992113                       | 993143          |                    | 202                          | 12              |
| 48-FP694   |                        |            |                  | 992116                       | 993146          |                    | 202                          | 12              |
| FA282265   |                        |            | 072132           |                              |                 |                    |                              | 11              |
| FA287265   |                        |            | 072131           |                              |                 |                    |                              | 11              |
| FA378265   |                        |            | 072132           |                              |                 |                    |                              | 11              |
| FP273  |                        |            | 072133           |                              |                 |                    |                              | 11              |
| FP274  |                        |            | 072014           |                              |                 |                    |                              | 10,11           |
| FP276  |                        |            | 072014           |                              |                 |                    |                              | 10,11           |
| FP277  |                        |            | 072131           |                              |                 |                    |                              | 11              |
| FP278  |                        |            | 072014           |                              |                 |                    |                              | 10,11           |
| FP282  |                        |            | 072132           |                              |                 |                    |                              | 11              |
| FP287  |                        |            | 072131           |                              |                 |                    |                              | 11              |
| FP293  |                        |            | 072132           |                              |                 |                    |                              | 11              |
| FP328  |                        |            | 072014           |                              |                 |                    |                              | 10,11           |
| FP366  |                        |            | 072014           |                              |                 |                    |                              | 10,11           |
| FP378  |                        |            | 072132           |                              |                 |                    |                              | 11              |
| FP519  |                        |            | 072055           |                              |                 |                    |                              | 12              |
| FP523  |                        |            | 072107           |                              |                 |                    |                              | 12              |
| FP524  |                        |            | 072108           |                              |                 |                    |                              | 12              |
| FP623  |                        |            | 072107           |                              |                 |                    |                              | 12              |
| FP654  |                        |            | 072108           |                              |                 |                    |                              | 12              |
| FP665  |                        |            | 071035           |                              |                 |                    |                              | 12              |
| FP669  |                        |            | 071035           |                              |                 |                    |                              | 12              |
| FP669-1  |                        |            | 071035           |                              |                 |                    |                              | 12              |
| FP682  |                        |            | 072127           |                              |                 |                    |                              | 12              |
| FP685-1  |                        |            | 072128           |                              |                 |                    |                              | 12              |
| FP692  |                        |            | 072127           |                              |                 |                    |                              | 12              |
| FP692-1  |                        |            | 072127           |                              |                 |                    |                              | 12              |
| FPM736   |                        |            | 031020           |                              |                 |                    |                              | 11              |
| FPM738   |                        |            | 031019           | 992408                       | 993408          |                    | 114                          | 11              |
| FPM752   |                        |            | 031058           | 395129                       | 992407          | 993407             | 114                          | 11              |
| FPM754   |                        |            | 031056           | 992405                       | 993405          |                    | 114                          | 11              |
| FPM756   |                        |            | 031015           |                              |                 |                    |                              | 11              |
| FPS523   |                        |            | 072107           |                              |                 |                    |                              | 12              |
| FPS524   |                        |            | 072108           |                              |                 |                    |                              | 12              |
| FPS623   |                        |            | 072107           |                              |                 |                    |                              | 12              |
| FPS625   |                        |            | 072108           |                              |                 |                    |                              | 12              |
| FPS626   |                        |            | 072109           |                              |                 |                    |                              | 12              |
| FPS654   |                        |            | 072108           |                              |                 |                    |                              | 12              |

\* Indicates limited quantities.

# MICHIGAN WHEEL OEM CROSS REFERENCE

| Original Equipment Manufacturer<br>Part & Trade Mark | Standard Hub Propeller |            |                  | XHS® / XHS II® Hub Propeller |                 |                    | XHS® / XHS II®<br>Hub Kit(s) | Catalog Page #s |
|--|------------------------|------------|------------------|------------------------------|-----------------|--------------------|------------------------------|-----------------|
|  | Michigan<br>Match®     | Ballistic® | Ballistic®<br>XL | Vortex®<br>XHS               | Apollo®<br>Std. | Apollo®<br>Lg. Dia |                              |                 |
| <b>HONDA®</b>  |                        |            |                  |                              |                 |                    |                              |                 |
| 08M60-ZW7-A10 Turbo 3-Blade                          | 031042                 | 335131     |                  | 992114                       | 993144          |                    | See Note 3                   | 15              |
| 08M60-ZW7-A20 Turbo 3-Blade                          | 031043                 | 335132     |                  | 992115                       | 993145          |                    | See Note 3                   | 15              |
| 08M60-ZW7-A30 Turbo 3-Blade                          | 031044                 | 335133     |                  | 992116                       | 993146          |                    | See Note 3                   | 15              |
| 08M60-ZW7-B00 Turbo 3-Blade (LH)                     |                        |            |                  |                              | 993153          |                    | See Note 3                   | 15              |
| 08M60-ZW7-B10 Turbo 3-Blade (LH)                     |                        |            |                  |                              | 993154          |                    | See Note 3                   | 15              |
| 08M60-ZW7-B20 Turbo 3-Blade (LH)                     |                        |            |                  |                              | 993155          |                    | See Note 3                   | 15              |
| 08M60-ZW7-B30 Turbo 3-Blade (LH)                     |                        |            |                  |                              | 993156          |                    | See Note 3                   | 15              |
| 58110-ZV4-300  | 102005                 |            |                  |                              |                 |                    |                              | 14              |
| 58110-ZV5-E00 Turbo 3-Blade                          | 032040                 | 395930     |                  | 992408                       | 993408          |                    | 113                          | 15              |
| 58110-ZV5-E10 Turbo 3-Blade                          | 032041                 |            |                  | 992606                       | 993407          |                    | 113                          | 15              |
| 58110-ZV5-E20 Turbo 3-Blade                          | 032042                 | 395929     |                  | 992605                       | 993406          |                    | 113                          | 15              |
| 58110-ZV5-E30 Turbo 3-Blade                          | 032043                 |            |                  | 992405                       | 993405          |                    | 113                          | 16              |
| 58130-881-840ZA                                      | 012109                 |            |                  |                              |                 |                    |                              | 14              |
| 58130-881-840ZB                                      | 012109                 |            |                  |                              |                 |                    |                              | 14              |
| 58130-935-000N                                       | 012109                 |            |                  |                              |                 |                    |                              | 14              |
| 58130-935-600N                                       | 012109                 |            |                  |                              |                 |                    |                              | 14              |
| 58130-ZV4-000ZA                                      | 102005                 |            |                  |                              |                 |                    |                              | 14              |
| 58130-ZV4-008AH Solas® Honda                         | 102003                 |            |                  |                              |                 |                    |                              | 14              |
| 58130-ZV4-009AH Solas® Honda                         | 102004                 |            |                  |                              |                 |                    |                              | 14              |
| 58130-ZV4-010ZA Solas® Honda                         | 102005                 |            |                  |                              |                 |                    |                              | 14              |
| 58130-ZV4-020ZA                                      | 102005                 |            |                  |                              |                 |                    |                              | 14              |
| 58130-ZV4-030ZA                                      | 102005                 |            |                  |                              |                 |                    |                              | 14              |
| 58130-ZV4-030ZB                                      | 102005                 |            |                  |                              |                 |                    |                              | 14              |
| 58130-ZV4-700ZA                                      | 102004                 |            |                  |                              |                 |                    |                              | 14              |
| 58130-ZV4-701ZA                                      | 102004                 |            |                  |                              |                 |                    |                              | 14              |
| 58130-ZV4-702ZA                                      | 102004                 |            |                  |                              |                 |                    |                              | 14              |
| 58130-ZV4-703ZA                                      | 102004                 |            |                  |                              |                 |                    |                              | 14              |
| 58130-ZV4-703ZB                                      | 102004                 |            |                  |                              |                 |                    |                              | 14              |
| 58130-ZV5-000ZA                                      | 032042                 | 395929     |                  | 992605                       | 993406          |                    | 113                          | 15              |
| 58130-ZV5-011AH Solas® Honda                         | 032044                 |            |                  | 992603                       | 993404          |                    | 113                          | 15              |
| 58130-ZV5-012AH Solas® Honda                         | 032043                 |            |                  | 992604                       | 993405          |                    | 113                          | 15              |
| 58130-ZV5-013AH Solas® Honda                         | 032042                 |            |                  | 992605                       | 993406          |                    | 113                          | 15              |
| 58130-ZV5-014AH Solas® Honda                         | 032041                 |            |                  | 992606                       | 993407          |                    | 113                          | 15              |
| 58130-ZV5-015AH Solas® Honda                         | 032040                 |            |                  | 992408                       | 993408          |                    | 113                          | 15              |
| 58130-ZV5-850ZA                                      | 032043                 |            |                  | 992604                       | 993405          |                    | 113                          | 15              |
| 58130-ZV5-860ZA                                      | 032045                 |            |                  | 992603                       |                 |                    | 113                          | 15              |
| 58130-ZV5-870ZA                                      | 032040                 | 395930     |                  | 992408                       | 993408          |                    | 113                          | 15              |
| 58130-ZV7-009AH Solas® Honda                         |                        |            |                  | 992501                       |                 |                    | 119                          | 14              |
| 58130-ZV7-010AH Solas® Honda                         |                        |            |                  | 992502                       |                 |                    | 119                          | 14              |
| 58130-ZV7-011AH Solas® Honda                         |                        |            |                  | 992503                       |                 |                    | 119                          | 14              |
| 58130-ZV7-012AH Solas® Honda                         |                        |            |                  | 992504                       |                 |                    | 119                          | 14              |
| 58130-ZV7-013AH Solas® Honda                         |                        | 305229     |                  | 992505                       |                 |                    | 119                          | 14              |
| 58130-ZW1-011AH Solas® Honda                         | 031054                 |            |                  |                              |                 |                    |                              | 15              |
| 58130-ZW1-013AH Solas® Honda                         | 031055                 |            |                  | 992112                       |                 |                    | See Note 3                   | 15              |
| 58130-ZW1-015AH Solas® Honda                         | 031041                 | 335130     |                  | 992113                       | 993143          |                    | See Note 3                   | 15              |
| 58130-ZW1-015B Solas® Honda (LH)                     |                        |            |                  |                              | 993153          |                    | See Note 3                   | 15              |
| 58130-ZW1-017AH Solas® Honda                         | 031042                 | 335131     |                  | 992114                       | 993144          |                    | See Note 3                   | 15              |
| 58130-ZW1-017B Solas® Honda (LH)                     |                        |            |                  |                              | 993154          |                    | See Note 3                   | 15              |
| 58130-ZW1-019AH Solas® Honda                         | 031043                 | 335132     |                  | 992115                       | 993145          |                    | See Note 3                   | 15              |
| 58130-ZW1-021AH Solas® Honda                         | 031044                 | 335133     | 335134           | 992116                       | 993146          |                    | See Note 3                   | 15              |
| 58130-ZW1-V01  | 031042                 | 335131     |                  | 992114                       | 993144          |                    | See Note 3                   | 15              |
| 58130-ZW1-V11  | 031043                 | 335132     |                  | 992115                       | 993145          |                    | See Note 3                   | 15              |
| 58130-ZW1-V31  | 031044                 | 335133     | 335134           | 992116                       | 993146          |                    | See Note 3                   | 15              |
| 58130-ZW1-W01ZA                                      | 031054                 |            |                  |                              |                 |                    |                              | 15              |
| 58130-ZW1-W11ZA                                      | 031055                 |            |                  | 992112                       |                 |                    | See Note 3                   | 15              |
| 58130-ZW1-W21ZA                                      | 031041                 | 335130     |                  | 992113                       | 993143          |                    | See Note 3                   | 15              |
| 58130-ZW1-W31ZA                                      | 031042                 | 335131     |                  | 992114                       | 993144          |                    | See Note 3                   | 15              |
| 58130-ZW1-W41ZA                                      | 031044                 | 335133     | 335134           | 992116                       | 993146          |                    | See Note 3                   | 15              |
| 58130-ZW1-W51ZA                                      | 031045*                |            |                  |                              |                 |                    |                              | 15              |
| 58130-ZW1-W61ZA                                      | 031043                 | 335132     |                  | 992115                       | 993145          |                    | See Note 3                   | 15              |
| 58130-ZW1-W91  | 031041                 | 335130     |                  | 992113                       | 993143          |                    | See Note 3                   | 15              |
| 58130-ZY3-013A Solas® Honda                          | 031022                 |            |                  |                              |                 |                    |                              | 16              |
| 58130-ZY3-015A Solas® Honda                          | 031023                 | 345131     |                  | 992002                       | 993042          | 993022             | 207                          | 17              |
| 58130-ZY3-017A Solas® Honda                          | 031024                 | 345132     |                  | 992003                       | 993043          | 993023             | 993203                       | 207             |
| 58130-ZY3-017AP Solas® Honda                         | 031064                 | 345132     |                  | 992003                       | 993043          | 993023             | 993203                       | 207             |
| 58130-ZY3-017B Solas® Honda (LH)                     |                        | 345162     |                  |                              | 993053          | 993033             | 993213                       | 207             |

\* Indicates limited quantities.

# MICHIGAN WHEEL OEM CROSS REFERENCE

| Original Equipment Manufacturer<br>Part & Trade Mark | Standard Hub Propeller |            |                  | XHS® / XHS II® Hub Propeller |                 |                    | XHS® / XHS II®<br>Hub Kit(s) | Catalog Page #s |                    |
|--|------------------------|------------|------------------|------------------------------|-----------------|--------------------|------------------------------|-----------------|--------------------|
|  | Michigan<br>Match®     | Ballistic® | Ballistic®<br>XL | Vortex®<br>XHS               | Apollo®<br>Std. | Apollo®<br>Lg. Dia |                              |                 | Apollo®<br>4-Blade |
| <b>HONDA® (Continued)</b>                            |                        |            |                  |                              |                 |                    |                              |                 |                    |
| 58130-ZY3-017BP..... Solas® Honda (LH).....          |                        | 345162     |                  |                              | 993053          | 993033             | 993213                       | 207             | 17                 |
| 58130-ZY3-017P..... Solas® Honda.....                | .031064                | 345132     |                  | 992003                       | 993043          | 993023             | 993203                       | 207             | 17                 |
| 58130-ZY3-019A..... Solas® Honda.....                | .031025                | 345133     |                  | 992004                       | 993044          | 993024             | 993204                       | 207             | 17                 |
| 58130-ZY3-019AP..... Solas® Honda.....               | .031065                | 345133     |                  | 992004                       | 993044          | 993024             | 993204                       | 207             | 17                 |
| 58130-ZY3-019B..... Solas® Honda (LH).....           |                        | 345163     |                  |                              | 993054          | 993034             | 993214                       | 207             | 17                 |
| 58130-ZY3-021A..... Solas® Honda.....                | .031026                | 345134     |                  | 992005                       | 993045          | 993025             | 993205                       | 207             | 17                 |
| 58130-ZY3-021B..... Solas® Honda (LH).....           |                        | 345164     |                  |                              | 993055          | 993035             | 993215                       | 207             | 17                 |
| 58130-ZY3-023A..... Solas® Honda.....                |                        | 345135     |                  | 992006                       | 993046          | 993026             | 993206                       | 207             | 17                 |
| 58130-ZY3-15B..... Solas® Honda.....                 |                        |            |                  |                              | 993052          |                    |                              | 207             | 17                 |
| 58133-ZV4-008AH..... Solas® Saturn.....              | 102003                 |            |                  |                              |                 |                    |                              |                 | 14                 |
| 58133-ZV4-009AH..... Solas® Saturn.....              | 102004                 |            |                  |                              |                 |                    |                              |                 | 14                 |
| 58133-ZV4-010AH..... Solas® Saturn.....              | 102005                 |            |                  |                              |                 |                    |                              |                 | 14                 |
| 58133-ZV5-012AH..... Solas® Saturn.....              | .032043                |            |                  | 992604                       | 993405          |                    |                              | 113             | 15                 |
| 58133-ZV5-013AH..... Solas® Saturn.....              | .032042                | 395929     |                  | 992605                       | 993406          |                    |                              | 113             | 15                 |
| 58133-ZV5-014AH..... Solas® Saturn.....              | .032041                |            |                  | 992606                       | 993407          |                    |                              | 113             | 15                 |
| 58133-ZV5-015AH..... Solas® Saturn.....              | .032040                | 395930     |                  | 992408                       | 993408          |                    |                              | 113             | 15                 |
| 58133-ZV7-013AH..... Solas® Saturn.....              |                        | 305229     |                  | 992505                       |                 |                    |                              | 119             | 14                 |
| 58133-ZW1-A11P..... Solas® New Saturn.....           | .031200                |            |                  |                              |                 |                    |                              |                 | 16                 |
| 58133-ZW1-A13P..... Solas® New Saturn.....           | .031202                |            |                  |                              |                 |                    |                              |                 | 16                 |
| 58133-ZW1-A15AH..... Solas® Titan.....               | .031041                | 335130     |                  | 992113                       | 993143          |                    |                              | See Note 3      | 16                 |
| 58133-ZW1-A15HR..... Solas® Titan HR3.....           | .031041                | 335130     |                  | 992113                       | 993143          |                    |                              | See Note 3      | 16                 |
| 58133-ZW1-A17AH..... Solas® Titan.....               | .031042                | 335131     |                  | 992114                       | 993144          |                    |                              | See Note 3      | 16                 |
| 58133-ZW1-A17HR..... Solas® Titan HR3.....           | .031042                | 335131     |                  | 992114                       | 993144          |                    |                              | See Note 3      | 16                 |
| 58133-ZW1-A19AH..... Solas® Titan.....               | .031043                | 335132     |                  | 992115                       | 993145          |                    |                              | See Note 3      | 16                 |
| 58133-ZW1-A19HR..... Solas® Titan HR3.....           | .031043                | 335132     |                  | 992115                       | 993145          |                    |                              | See Note 3      | 16                 |
| 58133-ZW1-A21HR..... Solas® Titan HR3.....           | .031044                | 335133     |                  | 992116                       | 993146          |                    |                              | See Note 3      | 16                 |
| 58133-ZW1-B15AH..... Solas® Titan (LH).....          |                        |            |                  |                              | 993153          |                    |                              | See Note 3      | 16                 |
| 58133-ZW1-B17AH..... Solas® Titan (LH).....          |                        |            |                  |                              | 993154          |                    |                              | See Note 3      | 16                 |
| 58133-ZW1-B17HR..... Solas® Titan HR3 (LH).....      |                        |            |                  |                              | 993154          |                    |                              | See Note 3      | 16                 |
| 58133-ZW1-B19AH..... Solas® Titan (LH).....          |                        |            |                  |                              | 993155          |                    |                              | See Note 3      | 16                 |
| 58133-ZW1-B19HR..... Solas® Titan HR3 (LH).....      |                        |            |                  |                              | 993155          |                    |                              | See Note 3      | 16                 |
| 58133-ZW1-B21HR..... Solas® Titan HR3 (LH).....      |                        |            |                  |                              | 993156          |                    |                              | See Note 3      | 16                 |
| 58133-ZY3-A15AH..... Solas® New Saturn.....          | .031023                | 345131     |                  | 992002                       | 993042          |                    |                              | 207             | 17                 |
| 58133-ZY3-A15LX..... Solas® Lexor.....               | .031024                | 345132     |                  | 992003                       | 993043          | 993023             | 993203                       | 207             | 17                 |
| 58133-ZY3-A15S..... Solas® Titan.....                | .031023                | 345131     |                  | 992002                       | 993042          |                    |                              | 207             | 17                 |
| 58133-ZY3-A17AH..... Solas® Titan.....               | .031024                | 345132     |                  | 992003                       | 993043          | 993023             | 993203                       | 207             | 17                 |
| 58133-ZY3-A17HR..... Solas® Titan HR3.....           | .031024                | 345132     |                  | 992003                       | 993043          | 993023             | 993203                       | 207             | 17                 |
| 58133-ZY3-A17LX..... Solas® Lexor.....               | .031065                | 345133     |                  | 992004                       | 993044          | 993024             | 993204                       | 207             | 17                 |
| 58133-ZY3-A17S..... Solas® Titan.....                | .031024                | 345132     |                  | 992003                       | 993043          | 993023             | 993203                       | 207             | 17                 |
| 58133-ZY3-A19AH..... Solas® Titan.....               | .031065                | 345133     |                  | 992004                       | 993044          | 993024             | 993204                       | 207             | 17                 |
| 58133-ZY3-A19HR..... Solas® Titan HR3.....           | .031065                | 345133     |                  | 992004                       | 993044          | 993024             | 993204                       | 207             | 17                 |
| 58133-ZY3-A19LX..... Solas® Lexor.....               | .031026                | 345134     |                  | 992005                       | 993045          | 993025             | 993205                       | 207             | 17                 |
| 58133-ZY3-A19S..... Solas® Titan.....                | .031065                | 345133     |                  | 992004                       | 993044          | 993024             | 993204                       | 207             | 17                 |
| 58133-ZY3-A21AH..... Solas® Titan.....               | .031026                | 345134     |                  | 992005                       | 993045          | 993025             | 993205                       | 207             | 17                 |
| 58133-ZY3-A21HR..... Solas® Titan HR.....            | .031026                | 345134     |                  | 992005                       | 993045          | 993025             | 993205                       | 207             | 17                 |
| 58133-ZY3-A21LX..... Solas® Lexor.....               |                        | 345135     |                  | 992006                       | 993046          | 993026             | 993206                       | 207             | 17                 |
| 58133-ZY3-A21S..... Solas® Titan.....                | .031026                | 345134     |                  | 992005                       | 993045          | 993025             | 993205                       | 207             | 17                 |
| 58133-ZY3-A23S..... Solas® Titan.....                |                        | 345135     |                  | 992006                       | 993046          | 993026             | 993206                       | 207             | 17                 |
| 58133-ZY3-A25AH..... Solas® Titan.....               |                        | 345136     |                  |                              |                 |                    |                              |                 | 16                 |
| 58133-ZY3-B15AH..... Solas® New Saturn (LH).....     |                        |            |                  |                              | 993052          |                    |                              | 207             | 17                 |
| 58133-ZY3-B15LX..... Solas® Lexor (LH).....          |                        | 345162     |                  |                              | 993053          | 993033             | 993213                       | 207             | 17                 |
| 58133-ZY3-B17AH..... Solas® New Saturn (LH).....     |                        | 345162     |                  |                              | 993053          | 993033             | 993213                       | 207             | 17                 |
| 58133-ZY3-B17HR..... Solas® Titan HR3 (LH).....      |                        | 345162     |                  |                              | 993053          | 993033             | 993213                       | 207             | 17                 |
| 58133-ZY3-B17S..... Solas® Titan (LH).....           |                        | 345162     |                  |                              | 993053          | 993033             | 993213                       | 207             | 17                 |
| 58133-ZY3-B19AH..... Solas® New Saturn (LH).....     |                        | 345163     |                  |                              | 993054          | 993034             | 993214                       | 207             | 17                 |
| 58133-ZY3-B19HR..... Solas® Titan HR3 (LH).....      |                        | 345163     |                  |                              | 993054          | 993034             | 993214                       | 207             | 17                 |
| 58133-ZY3-B19LX..... Solas® Lexor (LH).....          |                        | 345164     |                  |                              | 993055          | 993035             | 993215                       | 207             | 17                 |
| 58133-ZY3-B19S..... Solas® Titan (LH).....           |                        | 345163     |                  |                              | 993054          | 993034             | 993214                       | 207             | 17                 |
| 58133-ZY3-B21AH..... Solas® New Saturn (LH).....     |                        | 345164     |                  |                              | 993055          | 993035             | 993215                       | 207             | 17                 |
| 58133-ZY3-B21HR..... Solas® Titan HR3 (LH).....      |                        | 345164     |                  |                              | 993055          | 993035             | 993215                       | 207             | 17                 |
| 58133-ZY3-B21LX..... Solas® Lexor (LH).....          |                        | 345165     |                  |                              | 993056          | 993036             | 993216                       | 207             | 17                 |
| 58133-ZY3-B21S..... Solas® Titan (LH).....           |                        | 345164     |                  |                              | 993055          | 993035             | 993215                       | 207             | 17                 |
| 58133-ZY3-B23S..... Solas® Titan (LH).....           |                        | 345165     |                  |                              | 993056          | 993036             | 993216                       | 207             | 17                 |
| 58134-ZV5-009AH..... Solas® Honda.....               |                        |            |                  | 992402                       |                 |                    |                              | 113             | 15                 |
| 58134-ZV5-010AH..... Solas® Honda.....               |                        |            |                  | 992403                       |                 |                    |                              | 113             | 15                 |
| 58134-ZY3-017A..... Solas® Honda.....                |                        |            |                  | 992202                       |                 |                    | 993203                       | 207             | 17                 |

# MICHIGAN WHEEL OEM CROSS REFERENCE

| Original Equipment Manufacturer<br>Part & Trade Mark | Standard Hub Propeller |            |                  | XHS® / XHS II® Hub Propeller |                 |                    | XHS® / XHS II®<br>Hub Kit(s) | Catalog Page #s |
|--|------------------------|------------|------------------|------------------------------|-----------------|--------------------|------------------------------|-----------------|
|  | Michigan<br>Match®     | Ballistic® | Ballistic®<br>XL | Vortex®<br>XHS               | Apollo®<br>Std. | Apollo®<br>Lg. Dia |                              |                 |

## HONDA® (Continued)

|                 |                       |         |        |        |        |        |        |     |    |
|-----------------|-----------------------|---------|--------|--------|--------|--------|--------|-----|----|
| 58134-ZY3-017B  | Solas® Honda (LH)     |         |        |        |        |        | 993213 | 207 | 17 |
| 58134-ZY3-019A  | Solas® Honda          |         |        | 992203 |        |        | 993204 | 207 | 17 |
| 58134-ZY3-019B  | Solas® Honda (LH)     |         |        |        |        |        | 993214 | 207 | 17 |
| 58134-ZY3-021A  | Solas® Honda          |         |        | 992204 |        |        | 993205 | 207 | 17 |
| 58134-ZY3-021B  | Solas® Honda (LH)     |         |        |        |        |        | 993215 | 207 | 17 |
| 58134-ZY3-A18HR | Solas® Titan HR4      |         |        |        |        |        | 993204 | 207 | 17 |
| 58134-ZY3-A20HR | Solas® Titan HR4      |         |        |        |        |        | 993205 | 207 | 17 |
| 58134-ZY3-A21HR | Solas® Titan HR4      |         |        |        |        |        | 993205 | 207 | 17 |
| 58134-ZY3-B18HR | Solas® Titan HR4 (LH) |         |        |        |        |        | 993214 | 207 | 17 |
| 58134-ZY3-B20HR | Solas® Titan HR4 (LH) |         |        |        |        |        | 993215 | 207 | 17 |
| 58134-ZY3-B21HR | Solas® Titan HR4 (LH) |         |        |        |        |        | 993215 | 207 | 17 |
| 58233-ZY3-A15H  | Turbo 3-Blade         | .031023 | 345131 | 992002 | 993042 |        |        | 207 | 17 |
| 58233-ZY3-A17H  | Turbo 3-Blade         | .031024 | 345132 | 992003 | 993043 | 993023 | 993203 | 207 | 17 |
| 58233-ZY3-A19H  | Turbo 3-Blade         | .031025 | 345133 | 992004 | 993044 | 993024 | 993204 | 207 | 17 |
| 58233-ZY3-A21H  | Turbo 3-Blade         | .031026 | 345134 | 992005 | 993045 | 993025 | 993205 | 207 | 17 |
| 58233-ZY3-A23H  | Turbo 3-Blade         | .031027 | 345135 | 992006 | 993046 | 993026 | 993206 | 207 | 17 |
| 58233-ZY3-A23HP | Turbo Performance     | .031027 | 345135 | 992006 | 993046 | 993026 | 993206 | 207 | 17 |
| 58233-ZY3-A25H  | Turbo 3-Blade         |         | 345136 |        |        |        |        | 207 | 17 |
| 58233-ZY3-B15H  | Turbo 3-Blade (LH)    |         |        |        | 993052 |        |        | 207 | 17 |
| 58233-ZY3-B17H  | Turbo 3-Blade (LH)    |         | 345162 |        | 993053 | 993033 | 993213 | 207 | 17 |
| 58233-ZY3-B19H  | Turbo 3-Blade (LH)    |         | 345163 |        | 993054 | 993034 | 993214 | 207 | 17 |
| 58233-ZY3-B21H  | Turbo 3-Blade (LH)    |         | 345164 |        | 993055 | 993035 | 993215 | 207 | 17 |
| 58233-ZY3-B23H  | Turbo 3-Blade (LH)    |         | 345165 |        | 993056 | 993036 | 993216 | 207 | 17 |
| 58234-ZY3-A20H  | Turbo 4-Blade         | .031026 | 345134 | 992005 | 993045 | 993025 | 993205 | 207 | 17 |
| 58234-ZY3-A22H  | Turbo 4-Blade         | .031027 | 345135 | 992006 | 993046 | 993026 | 993206 | 207 | 17 |
| 58234-ZY3-A23HP | Turbo 4-Blade Perf.   | .031027 | 345135 | 992006 | 993046 | 993026 | 993206 | 207 | 17 |
| 58333-ZY3-A15CL | PowerTech OFS         |         | 345131 |        |        |        |        | 207 | 17 |
| 58333-ZY3-A17CL | PowerTech OFS         | .031024 | 345132 | 992003 | 993043 | 993023 | 993203 | 207 | 17 |
| 58333-ZY3-A19CL | PowerTech OFS         | .031025 | 345133 | 992004 | 993044 | 993024 | 993204 | 207 | 17 |
| 58333-ZY3-A21CL | PowerTech OFS         | .031026 | 345134 | 992005 | 993045 | 993025 | 993205 | 207 | 17 |
| 58333-ZY3-A23CL | PowerTech OFS         | .031027 | 345135 | 992006 | 993046 | 993026 | 993206 | 207 | 17 |
| 58333-ZY3-B17CL | PowerTech OFS (LH)    |         | 345162 |        | 993053 | 993033 | 993213 | 207 | 17 |
| 58333-ZY3-B19CL | PowerTech OFS (LH)    |         | 345163 |        | 993054 | 993034 | 993214 | 207 | 17 |
| 58333-ZY3-B21CL | PowerTech OFS (LH)    |         | 345164 |        | 993055 | 993035 | 993215 | 207 | 17 |
| 58333-ZY3-B23CL | PowerTech OFS (LH)    |         | 345165 |        | 993056 | 993036 | 993216 | 207 | 17 |

## MERCURY®, MARINER®, MERCURUISER®

|             |                   |         |        |        |        |        |        |        |     |       |
|-------------|-------------------|---------|--------|--------|--------|--------|--------|--------|-----|-------|
| 48-11070A40 | Laser™            |         | 345134 | 345141 |        | 993045 | 993025 | 993205 | 202 | 23,34 |
| 48-11074A40 | Laser™            |         | 345135 | 345137 |        | 993046 | 993026 | 993206 | 202 | 23,34 |
| 48-11320A40 | Black Max™        | .031050 |        |        | 992002 | 993042 |        |        | 202 | 23,34 |
| 48-11322A40 | Black Max™        | .031051 |        |        | 992003 | 993043 | 993023 | 993203 | 202 | 23,34 |
| 48-11324A40 | Black Max™        | .031052 | 345133 |        | 992004 | 993044 | 993024 | 993204 | 202 | 23,34 |
| 48-11324A45 | Black Max™        | .031052 | 345133 |        | 992004 | 993044 | 993024 | 993204 | 202 | 23,34 |
| 48-13242A5  | Mirage®           | .031065 | 345133 |        | 992004 | 993044 | 993024 | 993204 | 202 | 23,34 |
| 48-13242A50 | Mirage®           | .031065 | 345133 |        | 992004 | 993044 | 993024 | 993204 | 202 | 23,34 |
| 48-13243A5  | Mirage® (LH)      |         | 345164 |        |        | 993055 | 993035 | 993215 | 202 | 23,34 |
| 48-13243A50 | Mirage® (LH)      |         | 345164 |        |        | 993055 | 993035 | 993215 | 202 | 23,34 |
| 48-13244A5  | Mirage®           | .031066 | 345134 |        | 992005 | 993045 | 993025 | 993205 | 202 | 23,34 |
| 48-13244A50 | Mirage®           | .031066 | 345134 |        | 992005 | 993045 | 993025 | 993205 | 202 | 23,34 |
| 48-13245A5  | Mirage® (LH)      |         | 345165 |        |        | 993056 | 993036 | 993216 | 202 | 23,34 |
| 48-13245A50 | Mirage® (LH)      |         | 345165 |        |        | 993056 | 993036 | 993216 | 202 | 23,34 |
| 48-13700A46 | Mirage® Plus      |         |        |        |        |        | 993024 |        | 202 | 23,34 |
| 48-13701A40 | Mirage® (LH)      |         | 345163 |        |        |        |        |        | 202 | 23,34 |
| 48-13701A41 | Mirage® (LH)      |         | 345163 |        |        |        |        |        | 202 | 23,34 |
| 48-13701A45 | Mirage® Plus (LH) |         | 345163 |        |        |        |        |        | 202 | 23,34 |
| 48-13701A46 | Mirage® Plus (LH) |         | 345163 |        |        | 993054 | 993034 | 993214 | 202 | 23,34 |
| 48-13702A40 | Mirage®           | .031066 | 345134 |        | 992005 | 993045 | 993025 | 993205 | 202 | 23,34 |
| 48-13702A45 | Mirage® Plus      | .031066 | 345134 |        | 992005 | 993045 | 993025 | 993205 | 202 | 23,34 |
| 48-13702A46 | Mirage® Plus      | .031066 | 345134 |        | 992005 | 993045 | 993025 | 993205 | 202 | 23,34 |
| 48-13702A55 | Mirage® Plus      | .031066 | 345134 |        | 992005 | 993045 | 993025 | 993205 | 202 | 23,34 |
| 48-13703A40 | Mirage® (LH)      |         | 345164 |        |        | 993055 | 993035 | 993215 | 202 | 23,34 |
| 48-13703A41 | Mirage® (LH)      |         | 345164 |        |        | 993055 | 993035 | 993215 | 202 | 23,34 |
| 48-13703A45 | Mirage® Plus (LH) |         | 345164 |        |        | 993055 | 993035 | 993215 | 202 | 23,34 |
| 48-13703A46 | Mirage® Plus (LH) |         | 345164 |        |        | 993055 | 993035 | 993215 | 202 | 23,34 |
| 48-13703A55 | Mirage® Plus (LH) |         | 345164 |        |        | 993055 | 993035 | 993215 | 202 | 23,34 |
| 48-13704A40 | Mirage®           |         | 345135 |        | 992006 | 993046 | 993026 | 993206 | 202 | 23,34 |



# MICHIGAN WHEEL OEM CROSS REFERENCE

| Original Equipment Manufacturer<br>Part & Trade Mark |                   | Standard Hub Propeller |            |                  | XHS® / XHS II® Hub Propeller |                 |                    | XHS® / XHS II®<br>Hub Kit(s) | Catalog Page #s |                    |
|--|-------------------|------------------------|------------|------------------|------------------------------|-----------------|--------------------|------------------------------|-----------------|--------------------|
|  |                   | Michigan<br>Match®     | Ballistic® | Ballistic®<br>XL | Vortex®<br>XHS               | Apollo®<br>Std. | Apollo®<br>Lg. Dia |                              |                 | Apollo®<br>4-Blade |
| <b>MERCURY®, MARINER®, MERCURISER® (Continued)</b>   |                   |                        |            |                  |                              |                 |                    |                              |                 |                    |
| 48-13704A41  | Mirage®           |                        | 345135     |                  | 992006                       | 993046          | 993026             | 993206                       | 202             | 23,34              |
| 48-13704A45  | Mirage® Plus      |                        | 345135     |                  | 992006                       | 993046          | 993026             | 993206                       | 202             | 23,34              |
| 48-13704A46  | Mirage® Plus      |                        | 345135     |                  | 992006                       | 993046          | 993026             | 993206                       | 202             | 23,34              |
| 48-13705A40  | Mirage® (LH)      |                        | 345165     |                  | 993056                       | 993036          | 993216             | 993216                       | 202             | 23,34              |
| 48-13705A41  | Mirage® (LH)      |                        | 345165     |                  | 993056                       | 993036          | 993216             | 993216                       | 202             | 23,34              |
| 48-13705A45  | Mirage® Plus (LH) |                        | 345165     |                  | 993056                       | 993036          | 993216             | 993216                       | 202             | 23,34              |
| 48-13705A46  | Mirage® Plus (LH) |                        | 345165     |                  | 993056                       | 993036          | 993216             | 993216                       | 202             | 23,34              |
| 48-13705A55  | Mirage® Plus (LH) |                        | 345165     |                  |                              |                 |                    |                              |                 | 23,34              |
| 48-13706A40  | Mirage®           |                        | 345136     |                  |                              |                 |                    |                              |                 | 23,34              |
| 48-13706A41  | Mirage®           |                        | 345136     |                  |                              |                 |                    |                              |                 | 23,34              |
| 48-13706A45  | Mirage® Plus      |                        | 345136     |                  |                              |                 |                    |                              |                 | 23,34              |
| 48-13706A46  | Mirage® Plus      |                        | 345136     |                  |                              |                 |                    |                              |                 | 23,34              |
| 48-16312A4   | QSS™              | 031023                 | 345131     |                  | 992002                       | 993042          |                    |                              | 202             | 23,34              |
| 48-16312A5   | QSS™              | 031023                 | 345131     |                  | 992002                       | 993042          |                    |                              | 202             | 23,34              |
| 48-16312A45  | Vengeance         | 031023                 | 345131     |                  | 992002                       | 993042          |                    |                              | 202             | 23,34              |
| 48-16312A46  | Vengeance         | 031023                 | 345131     |                  | 992002                       | 993042          |                    |                              | 202             | 23,34              |
| 48-16314A4   | QSS™              | 031064                 | 345132     |                  | 992003                       | 993043          | 993023             | 993203                       | 202             | 23,34              |
| 48-16314A5   | QSS™              | 031064                 | 345132     |                  | 992003                       | 993043          | 993023             | 993203                       | 202             | 23,34              |
| 48-16314A45  | Vengeance         | 031064                 | 345132     |                  | 992003                       | 993043          | 993023             | 993203                       | 202             | 23,34              |
| 48-16314A46  | Vengeance         | 031064                 | 345132     |                  | 992003                       | 993043          | 993023             | 993203                       | 202             | 23,34              |
| 48-16315A4   | QSS™ (LH)         |                        | 345162     |                  | 993053                       | 993033          | 993213             | 993213                       | 202             | 23,34              |
| 48-16315A5   | QSS™ (LH)         |                        | 345162     |                  | 993053                       | 993033          | 993213             | 993213                       | 202             | 23,34              |
| 48-16315A45  | Vengeance (LH)    |                        | 345162     |                  | 993053                       | 993033          | 993213             | 993213                       | 202             | 23,34              |
| 48-16315A46  | Vengeance (LH)    |                        | 345162     |                  | 993053                       | 993033          | 993213             | 993213                       | 202             | 23,34              |
| 48-16316A4   | QSS™              | 031065                 | 345133     |                  | 992004                       | 993044          | 993024             | 993204                       | 202             | 23,34              |
| 48-16316A5   | QSS™              | 031065                 | 345133     |                  | 992004                       | 993044          | 993024             | 993204                       | 202             | 23,34              |
| 48-16316A45  | Vengeance         | 031065                 | 345133     |                  | 992004                       | 993044          | 993024             | 993204                       | 202             | 23,34              |
| 48-16316A46  | Vengeance         | 031065                 | 345133     |                  | 992004                       | 993044          | 993024             | 993204                       | 202             | 23,34              |
| 48-16317A4   | QSS™ (LH)         |                        | 345163     |                  | 993054                       | 993034          | 993214             | 993214                       | 202             | 23,34              |
| 48-16317A5   | QSS™ (LH)         |                        | 345163     |                  | 993054                       | 993034          | 993214             | 993214                       | 202             | 23,34              |
| 48-16317A45  | Vengeance (LH)    |                        | 345163     |                  | 993054                       | 993034          | 993214             | 993214                       | 202             | 23,34              |
| 48-16317A46  | Vengeance (LH)    |                        | 345163     |                  | 993054                       | 993034          | 993214             | 993214                       | 202             | 23,34              |
| 48-16318A4   | QSS™              | 031066                 | 345134     |                  | 992005                       | 993045          | 993025             | 993205                       | 202             | 23,34              |
| 48-16318A5   | QSS™              | 031066                 | 345134     |                  | 992005                       | 993045          | 993025             | 993205                       | 202             | 23,34              |
| 48-16318A45  | Vengeance         | 031066                 | 345134     |                  | 992005                       | 993045          | 993025             | 993205                       | 202             | 23,34              |
| 48-16318A46  | Vengeance         | 031066                 | 345134     |                  | 992005                       | 993045          | 993025             | 993205                       | 202             | 23,34              |
| 48-16319A4   | QSS™ (LH)         |                        | 345164     |                  | 993055                       | 993035          | 993215             | 993215                       | 202             | 23,34              |
| 48-16319A5   | QSS™ (LH)         |                        | 345164     |                  | 993055                       | 993035          | 993215             | 993215                       | 202             | 23,34              |
| 48-16319A45  | Vengeance (LH)    |                        | 345164     |                  | 993055                       | 993035          | 993215             | 993215                       | 202             | 23,34              |
| 48-16319A46  | Vengeance (LH)    |                        | 345164     |                  | 993055                       | 993035          | 993215             | 993215                       | 202             | 23,34              |
| 48-16320A4   | QSS™              |                        | 345135     |                  | 992006                       | 993046          | 993026             | 993206                       | 202             | 23,34              |
| 48-16320A5   | QSS™              |                        | 345135     |                  | 992006                       | 993046          | 993026             | 993206                       | 202             | 23,34              |
| 48-16321A4   | QSS™              |                        | 345135     |                  | 992006                       | 993046          | 993026             | 993206                       | 202             | 23,34              |
| 48-16320A45  | Vengeance         |                        | 345135     |                  | 992006                       | 993046          | 993026             | 993206                       | 202             | 23,34              |
| 48-16320A46  | Vengeance         |                        | 345135     |                  | 992006                       | 993046          | 993026             | 993206                       | 202             | 23,34              |
| 48-16320A5   | QSS™              |                        | 345135     |                  | 992006                       | 993046          | 993026             | 993206                       | 202             | 23,34              |
| 48-16321A4   | QSS™ (LH)         |                        | 345165     |                  | 993056                       | 993036          | 993216             | 993216                       | 202             | 23,34              |
| 48-16321A5   | QSS™ (LH)         |                        | 345165     |                  | 993056                       | 993036          | 993216             | 993216                       | 202             | 23,34              |
| 48-16321A45  | Vengeance (LH)    |                        | 345165     |                  | 993056                       | 993036          | 993216             | 993216                       | 202             | 23,34              |
| 48-16321A46  | Vengeance (LH)    |                        | 345165     |                  | 993056                       | 993036          | 993216             | 993216                       | 202             | 23,34              |
| 48-16322A4   | QSS™              |                        | 345136     |                  |                              |                 |                    |                              |                 | 23,34              |
| 48-16322A45  |                   |                        | 345136     |                  |                              |                 |                    |                              |                 | 23,34              |
| 48-16322A46  | Vengeance         |                        | 345136     |                  |                              |                 |                    |                              |                 | 23,34              |
| 48-16438A40  | Black Max™        | 031050                 |            |                  | 992002                       | 993042          |                    |                              | 202             | 23,34              |
| 48-16438A45  | Black Max™        | 031050                 |            |                  | 992002                       | 993042          |                    |                              | 202             | 23,34              |
| 48-16440A40  | Black Max™        | 031051                 |            |                  | 992003                       | 993043          | 993023             | 993203                       | 202             | 23,34              |
| 48-16440A45  | Black Max™        | 031051                 |            |                  | 992003                       | 993043          | 993023             | 993203                       | 202             | 23,34              |
| 48-16543A40  | Laser II™ (LH)    |                        | 345163     |                  | 993054                       | 993034          | 993214             | 993214                       | 202             | 23,34              |
| 48-16543A41  | Laser II™ (LH)    |                        | 345163     |                  | 993054                       | 993034          | 993214             | 993214                       | 202             | 23,34              |
| 48-16543A45  | Laser II™ (LH)    |                        | 345163     |                  | 993054                       | 993034          | 993214             | 993214                       | 202             | 23,34              |
| 48-16543A46  | Laser II™ (LH)    |                        | 345163     |                  | 993054                       | 993034          | 993214             | 993214                       | 202             | 23,34              |
| 48-16544A40  | Laser II™         | 031065                 | 345133     |                  | 992004                       | 993044          | 993024             | 993204                       | 202             | 23,34              |
| 48-16544A41  | Laser II™         | 031065                 | 345133     |                  | 992004                       | 993044          | 993024             | 993204                       | 202             | 23,34              |
| 48-16544A45  | Laser II™         | 031065                 | 345133     |                  | 992004                       | 993044          | 993024             | 993204                       | 202             | 23,34              |
| 48-16544A46  | Laser II™         | 031065                 | 345133     |                  | 992004                       | 993044          | 993024             | 993204                       | 202             | 23,34              |
| 48-16545A40  | Laser II™ (LH)    |                        | 345164     |                  | 993055                       | 993035          | 993215             | 993215                       | 202             | 23,34              |

# MICHIGAN WHEEL OEM CROSS REFERENCE

| Original Equipment Manufacturer<br>Part & Trade Mark | Standard Hub Propeller |            |                  | XHS® / XHS II® Hub Propeller |                 |                    | XHS® / XHS II®<br>Hub Kit(s) | Catalog Page #s |                    |
|--|------------------------|------------|------------------|------------------------------|-----------------|--------------------|------------------------------|-----------------|--------------------|
|  | Michigan<br>Match®     | Ballistic® | Ballistic®<br>XL | Vortex®<br>XHS               | Apollo®<br>Std. | Apollo®<br>Lg. Dia |                              |                 | Apollo®<br>4-Blade |
| <b>MERCURY®, MARINER®, MERCUISER® (Continued)</b>    |                        |            |                  |                              |                 |                    |                              |                 |                    |
| 48-16545A41  | Laser II™ (LH)         |            | 345164           |                              | 993055          | 993035             | 993215                       | 202             | 23,34              |
| 48-16545A45  | Laser II™ (LH)         |            | 345164           |                              | 993055          | 993035             | 993215                       | 202             | 23,34              |
| 48-16545A46  | Laser II™ (LH)         |            | 345164           |                              | 993055          | 993035             | 993215                       | 202             | 23,34              |
| 48-16546A40  | Laser II™              | .031066    | 345134           | 992005                       | 993045          | 993025             | 993205                       | 202             | 23,34              |
| 48-16546A41  | Laser II™              | .031066    | 345134           | 992005                       | 993045          | 993025             | 993205                       | 202             | 23,34              |
| 48-16546A45  | Laser II™              | .031066    | 345134           | 992005                       | 993045          | 993025             | 993205                       | 202             | 23,34              |
| 48-16546A46  | Laser II™              | .031066    | 345134           | 992005                       | 993045          | 993025             | 993205                       | 202             | 23,34              |
| 48-16547A40  | Laser II™ (LH)         |            | 345165           |                              | 993056          | 993036             | 993216                       | 202             | 23,34              |
| 48-16547A41  | Laser II™ (LH)         |            | 345165           |                              | 993056          | 993036             | 993216                       | 202             | 23,34              |
| 48-16547A45  | Laser II™ (LH)         |            | 345165           |                              | 993056          | 993036             | 993216                       | 202             | 23,34              |
| 48-16547A46  | Laser II™ (LH)         |            | 345165           |                              | 993056          | 993036             | 993216                       | 202             | 23,34              |
| 48-16548A40  | Laser II™              |            | 345135           | 992006                       | 993046          | 993026             | 993206                       | 202             | 23,34              |
| 48-16548A41  | Laser II™              |            | 345135           | 992006                       | 993046          | 993026             | 993206                       | 202             | 23,34              |
| 48-16548A45  | Laser II™              |            | 345135           | 992006                       | 993046          | 993026             | 993206                       | 202             | 23,34              |
| 48-16548A46  | Laser II™              |            | 345165           |                              | 993056          | 993036             | 993216                       | 202             | 23,34              |
| 48-16550A40  | Laser II™              |            | 345136           |                              |                 |                    |                              |                 | 23,34              |
| 45-16550A41  | Laser II™              |            | 345136           |                              |                 |                    |                              |                 | 23,34              |
| 48-16550A45  | Laser II™              |            | 345136           |                              |                 |                    |                              |                 | 23,34              |
| 48-16550A46  | Laser II™              |            | 345136           |                              |                 |                    |                              |                 | 23,34              |
| 48-16986A5   | QSS™                   | .031041    | 335130           | 992113                       | 993143          |                    |                              | See Note 3      | 22                 |
| 48-16986A45  | Vengeance              | .031041    | 335130           | 992113                       | 993143          |                    |                              | See Note 3      | 22                 |
| 48-16986A46  | Vengeance              | .031041    | 335130           | 992113                       | 993143          |                    |                              | See Note 3      | 22                 |
| 48-16988A5   | QSS™                   | .031042    | 335131           | 992114                       | 993144          |                    |                              | See Note 3      | 22                 |
| 48-16988A45  | Vengeance              | .031042    | 335131           | 992114                       | 993144          |                    |                              | See Note 3      | 22                 |
| 48-16988A46  | Vengeance              | .031042    | 335131           | 992114                       | 993144          |                    |                              | See Note 3      | 22                 |
| 48-16990A40  | Laser II™              | .031043    | 335132           | 992115                       | 993145          |                    |                              | See Note 3      | 22                 |
| 48-16990A45  | Laser II™              | .031043    | 335132           | 992115                       | 993145          |                    |                              | See Note 3      | 22                 |
| 48-16992A40  | Laser II™              | .031044    | 335133           | 992116                       | 993146          |                    |                              | See Note 3      | 22                 |
| 48-16994A46  | Laser II™              |            | 335135           |                              |                 |                    |                              |                 | 22                 |
| 48-17874A12  |                        | .032050    |                  |                              |                 |                    |                              |                 | 18                 |
| 48-18278A46  | Mirage® Plus           |            | 345132           |                              | 993043          | 993023             |                              | 202             | 23,34              |
| 48-19636A10  | Black Max™             |            |                  | 992501                       |                 |                    |                              |                 | 19                 |
| 48-19638A40  | Black Max™             | .031049    |                  | 992503                       |                 |                    |                              | 120             | 19                 |
| 48-19639A40  | Black Max™             |            |                  | 992504                       |                 |                    |                              | 120             | 19                 |
| 48-19640A40  | Black Max™             | .031045*   | 305129           | 992505                       |                 |                    |                              | 120             | 19                 |
| 48-19642A40  | Black Max™             |            | 305130           | 992506                       |                 |                    |                              | 120             | 19                 |
| 48-19644A5   | Vengeance              |            | 305129           |                              |                 |                    |                              |                 | 19                 |
| 48-19841A46  | Mirage® Plus (LH)      |            |                  |                              | 993052          | 993032             |                              | 202             | 23,34              |
| 48-30388A1   |                        | .031042    | 335131           | 992114                       | 993144          |                    |                              | See Note 3      | 22                 |
| 48-30390A1   |                        | .031041    | 335130           | 992113                       | 993143          |                    |                              | See Note 3      | 22                 |
| 48-30396A1   |                        | .031054    |                  |                              |                 |                    |                              |                 | 22                 |
| 48-30396A3   |                        | .031054    |                  |                              |                 |                    |                              |                 | 22                 |
| 48-30396A4   |                        | .031054    |                  |                              |                 |                    |                              |                 | 22                 |
| 48-31072A4   |                        | .031041    | 335130           | 992113                       | 993143          |                    |                              | See Note 3      | 22                 |
| 48-31080A1   |                        | .031042    | 335131           | 992114                       | 993144          |                    |                              | See Note 3      | 22                 |
| 48-31082A1   |                        | .031041    | 335130           | 992113                       | 993143          |                    |                              | See Note 3      | 22                 |
| 48-31454A3   |                        | .031043    | 335132           | 992115                       | 993145          |                    |                              | See Note 3      | 22                 |
| 48-31456A3   |                        | .031042    | 335131           | 992114                       | 993144          |                    |                              | See Note 3      | 22                 |
| 48-31458A3   |                        | .031041    | 335130           | 992113                       | 993143          |                    |                              | See Note 3      | 22                 |
| 48-32264A3   |                        | .031041    | 335130           | 992113                       | 993143          |                    |                              | See Note 3      | 22                 |
| 48-32386A3   |                        | .031043    | 335132           | 992115                       | 993145          |                    |                              | See Note 3      | 22                 |
| 48-32386A4   |                        | .031048    |                  |                              |                 |                    |                              |                 | 22                 |
| 48-32388A3   |                        | .031042    | 335131           | 992114                       | 993144          |                    |                              | See Note 3      | 22                 |
| 48-32990A3   |                        | .031055    |                  | 992112                       |                 |                    |                              | See Note 3      | 22                 |
| 48-32392A3   |                        | .031054    |                  |                              |                 |                    |                              |                 | 22                 |
| 48-32392A4   |                        | .031055    |                  | 992112                       |                 |                    |                              | See Note 3      | 22                 |
| 48-32746A3   |                        | .031043    | 335132           | 992115                       | 993145          |                    |                              | See Note 3      | 22                 |
| 48-32748A3   |                        | .031042    | 335131           | 992114                       | 993144          |                    |                              | See Note 3      | 22                 |
| 48-32750A3   |                        | .031042    | 335131           | 992114                       | 993144          |                    |                              | See Note 3      | 22                 |
| 48-33480A1   |                        | .032135    |                  |                              |                 |                    |                              |                 | 18                 |
| 48-33482A1   |                        | .032136    |                  |                              |                 |                    |                              |                 | 18                 |
| 48-35936A3   |                        | .031054    |                  |                              |                 |                    |                              |                 | 22                 |
| 48-35936A4   |                        | .031055    |                  |                              |                 |                    |                              |                 | 22                 |
| 48-36008A1   |                        |            | 345135           | 992006                       | 993046          | 993026             | 993206                       | 202             | 23,34              |
| 48-36010A1   |                        | .031026    | 345134           | 992005                       | 993045          | 993025             | 993205                       | 202             | 23,34              |
| 48-36010A4   |                        |            | 345135           | 992006                       | 993046          | 993026             | 993206                       | 202             | 23,34              |

\* Indicates limited quantities.

# MICHIGAN WHEEL OEM CROSS REFERENCE

| Original Equipment Manufacturer<br>Part & Trade Mark | Standard Hub Propeller |            |                  | XHS® / XHS II® Hub Propeller |                 |                    | XHS® / XHS II®<br>Hub Kit(s) | Catalog Page #s |                    |
|--|------------------------|------------|------------------|------------------------------|-----------------|--------------------|------------------------------|-----------------|--------------------|
|  | Michigan<br>Match®     | Ballistic® | Ballistic®<br>XL | Vortex®<br>XHS               | Apollo®<br>Std. | Apollo®<br>Lg. Dia |                              |                 | Apollo®<br>4-Blade |
| <b>MERCURY®, MARINER®, MERCUISER® (Continued)</b>    |                        |            |                  |                              |                 |                    |                              |                 |                    |
| 48-36012A1   | .031052                | 345133     |                  | .992004                      | 993044          | .993024            | .993204                      | 202             | 23,34              |
| 48-36012A4   | .031026                | 345134     |                  | .992005                      | 993045          | .993025            | .993205                      | 202             | 23,34              |
| 48-36012A5   | .031051                | 345131     |                  | .992002                      | 993043          | .993023            | .993203                      | 202             | 23,34              |
| 48-36014A1   | .031051                | 345131     |                  | .992002                      | 993043          | .993023            | .993203                      | 202             | 23,34              |
| 48-36014A4   | .032052                | 345133     |                  | .992004                      | 993044          | .993024            | .993204                      | 202             | 23,34              |
| 48-36016A4   | .031051                | 345131     |                  | .992002                      | 993043          | .993023            | .993203                      | 202             | 23,34              |
| 48-36018A1   | .031022                |            |                  |                              |                 |                    |                              |                 | 23,34              |
| 48-36020A1   | .031022                |            |                  |                              |                 |                    |                              |                 | 23,34              |
| 48-36020A4   | .031022                |            |                  |                              |                 |                    |                              |                 | 23,34              |
| 48-37902A4   | .031042                | 335131     |                  | .992114                      | 993144          |                    |                              | See Note 3      | 22                 |
| 48-42522A10  | .032052                |            |                  |                              |                 |                    |                              |                 | 18                 |
| 48-42522A11  | .032052                |            |                  |                              |                 |                    |                              |                 | 18                 |
| 48-42522A12  | .032052                |            |                  |                              |                 |                    |                              |                 | 18                 |
| 48-42738A10  | .032141                | Black Max™ |                  |                              |                 |                    |                              |                 | 21                 |
| 48-42738A11  | .032141                | Black Max™ |                  |                              |                 |                    |                              |                 | 21                 |
| 48-42738A13  | .032141                | Black Max™ |                  |                              |                 |                    |                              |                 | 21                 |
| 48-42740A10  | .032142                | Black Max™ |                  |                              |                 |                    |                              |                 | 21                 |
| 48-42740A11  | .032142                | Black Max™ |                  |                              |                 |                    |                              |                 | 21                 |
| 48-43584A40  | .031049                |            |                  | .992503                      |                 |                    |                              | 120             | 19                 |
| 48-43586A40  | .031048                | 305130     |                  | .992505                      |                 |                    |                              | 120             | 19                 |
| 48-43590A40  |                        |            |                  | .992506                      |                 |                    |                              | 120             | 19                 |
| 48-47670A1   | .032020                |            |                  |                              |                 |                    |                              |                 | 18                 |
| 48-47670A10  | .032020                |            |                  |                              |                 |                    |                              |                 | 18                 |
| 48-47670A3   | .032020                |            |                  |                              |                 |                    |                              |                 | 18                 |
| 48-47922A1   | .032021                |            |                  |                              |                 |                    |                              |                 | 18                 |
| 48-47922A10  | .032021                |            |                  |                              |                 |                    |                              |                 | 18                 |
| 48-47926A1   | .032021                |            |                  |                              |                 |                    |                              |                 | 18                 |
| 48-47926A10  | .032021                |            |                  |                              |                 |                    |                              |                 | 18                 |
| 48-49632A3   | .031042                | 335131     |                  | .992114                      | 993144          |                    |                              | See Note 3      | 22                 |
| 48-49632A4   | .031043                | 335132     |                  | .992115                      | 993145          |                    |                              | See Note 3      | 22                 |
| 48-49634A1   | .031052                |            |                  | .992004                      | 993044          | .993024            | .993204                      | 202             | 23,34              |
| 48-49634A4   | .031052                |            |                  | .992004                      | 993044          | .993024            | .993204                      | 202             | 23,34              |
| 48-52008A3   | .031045*               |            |                  |                              |                 |                    |                              |                 | 22                 |
| 48-52008A4   | .031045*               |            |                  |                              |                 |                    |                              |                 | 22                 |
| 48-52012A3   | .031045*               |            |                  |                              |                 |                    |                              |                 | 22                 |
| 48-53892A3   | .031043                | 335132     |                  | .992115                      | 993145          |                    |                              | See Note 3      | 22                 |
| 48-53896A3   | .031042                | 335131     |                  | .992114                      | 993144          |                    |                              | See Note 3      | 22                 |
| 48-53896A4   | .031043                | 335132     |                  | .992115                      | 993145          |                    |                              | See Note 3      | 22                 |
| 48-53900A3   | .031041                | 335130     |                  | .992113                      | 993143          |                    |                              | See Note 3      | 22                 |
| 48-58422A1   | .031051                |            |                  | .992003                      | 993043          | .993023            | .993203                      | 202             | 23,34              |
| 48-58422A4   | .031052                |            |                  | .992004                      | 993044          | .993024            | .993204                      | 202             | 23,34              |
| 48-58424A4   | .031026                | 345134     |                  | .992005                      | 993045          | .993025            | .993205                      | 202             | 23,34              |
| 48-58426A1   | .031026                | 345134     |                  | .992005                      | 993045          | .993025            | .993205                      | 202             | 23,34              |
| 48-58426A4   |                        |            |                  | .992006                      | 993046          | .993026            | .993206                      | 202             | 23,34              |
| 48-58826A3   | .031054                |            |                  |                              |                 |                    |                              |                 | 22                 |
| 48-58826A4   | .031055                |            |                  | .992112                      |                 |                    |                              | 202             | 22                 |
| 48-61812A1   | .032045                |            |                  |                              |                 |                    |                              |                 | 20                 |
| 48-61812A4   | .032045                |            |                  |                              |                 |                    |                              |                 | 20                 |
| 48-61814A1   | .032044                |            |                  | .992603                      |                 |                    |                              | 114             | 20                 |
| 48-61814A4   | .032044                |            |                  | .992603                      |                 |                    |                              | 114             | 20                 |
| 48-61816A1   | .032043                | 395929     |                  | .992604                      | 993405          |                    |                              | 114             | 20                 |
| 48-61816A4   | .032043                | 395929     |                  | .992604                      | 993405          |                    |                              | 114             | 20                 |
| 48-61818A1   | .032042                |            |                  | .992605                      | 993406          |                    |                              | 114             | 20                 |
| 48-61818A4   | .032042                |            |                  | .992605                      | 993406          |                    |                              | 114             | 20                 |
| 48-61820A1   | .032041                |            |                  | .992606                      | 993407          |                    |                              | 114             | 20                 |
| 48-61820A4   | .032041                |            |                  | .992606                      | 993407          |                    |                              | 114             | 20                 |
| 48-61822A1   | .032040                | 395930     |                  | .992408                      | 993408          |                    |                              | 114             | 20                 |
| 48-61822A4   | .032040                | 395930     |                  | .992408                      | 993408          |                    |                              | 114             | 20                 |
| 48-61824A1   |                        |            |                  | .992409                      |                 |                    |                              | 114             | 20                 |
| 48-62274A1   | .032045                |            |                  |                              |                 |                    |                              |                 | 20                 |
| 48-62274A4   | .032045                |            |                  |                              |                 |                    |                              |                 | 20                 |
| 48-63540A1   | .032040                | 395930     |                  | .992408                      | 993408          |                    |                              | 114             | 20                 |
| 48-63542A1   | .032041                |            |                  | .992407                      | 993407          |                    |                              | 114             | 20                 |
| 48-63542A4   | .032041                |            |                  | .992407                      | 993407          |                    |                              | 114             | 20                 |
| 48-63544A1   | .032042                | 395929     |                  | .992406                      | 993406          |                    |                              | 114             | 20                 |
| 48-63544A4   | .032042                | 395929     |                  | .992406                      | 993406          |                    |                              | 114             | 20                 |

\* Indicates limited quantities.

# MICHIGAN WHEEL OEM CROSS REFERENCE

| Original Equipment Manufacturer<br>Part & Trade Mark | Standard Hub Propeller |               |                  | XHS® / XHS II® Hub Propeller |                 |                    | XHS® / XHS II®<br>Hub Kit(s) | Catalog Page #s |                    |
|--|------------------------|---------------|------------------|------------------------------|-----------------|--------------------|------------------------------|-----------------|--------------------|
|  | Michigan<br>Match®     | Ballistic®    | Ballistic®<br>XL | Vortex®<br>XHS               | Apollo®<br>Std. | Apollo®<br>Lg. Dia |                              |                 | Apollo®<br>4-Blade |
| <b>MERCURY®, MARINER®, MERCUISER® (Continued)</b>    |                        |               |                  |                              |                 |                    |                              |                 |                    |
| 48-63546A4   | .032043                | 395929        |                  | 992406                       | 993406          |                    | 114                          | 20              |                    |
| 48-64724A1   | .031020                |               |                  |                              |                 |                    |                              | 20              |                    |
| 48-64724A4   | .031020                |               |                  |                              |                 |                    |                              | 20              |                    |
| 48-65022A1   | .031041                |               |                  | 992113                       | 993143          |                    | See Note 3                   | 22              |                    |
| 48-65024A1   | .031042                |               |                  | 992114                       | 993144          |                    | See Note 3                   | 22              |                    |
| 48-65480A1   | .031027                |               |                  | 992006                       | 993046          | 993026             | 993206                       | 202 23,34       |                    |
| 48-65588A1   | .031042                | 335131        |                  | 992114                       | 993144          |                    | See Note 3                   | 22              |                    |
| 48-65588A4   | .031042                | 335131        |                  | 992114                       | 993144          |                    | See Note 3                   | 22              |                    |
| 48-65736A1   | .031045*               |               |                  |                              |                 |                    |                              | 22              |                    |
| 48-65736A4   | .031045*               |               |                  |                              |                 |                    |                              | 22              |                    |
| 48-65748A1   | .031041                |               |                  | 992407                       | 993407          |                    | 114                          | 20              |                    |
| 48-65992A1   | .031026                | 345134        |                  | 992005                       | 993045          | 993025             | 993205                       | 202 23,34       |                    |
| 48-65992A4   | .031026                | 345134        |                  | 992005                       | 993045          | 993025             | 993205                       | 202 23,34       |                    |
| 48-66432A1   | .031051                |               |                  | 992003                       | 993043          | 993023             | 993203                       | 202 23,34       |                    |
| 48-66432A4   | .031052                |               |                  | 992004                       | 993044          | 993024             | 993204                       | 202 23,34       |                    |
| 48-66450A4   | .031051                |               |                  | 992003                       | 993043          | 993023             | 993203                       | 202 23,34       |                    |
| 48-67280A1   | .031043                | 335132        |                  | 992115                       | 993145          |                    | See Note 3                   | 22              |                    |
| 48-67874A4   | .031027                |               |                  | 992006                       | 993046          |                    | 993206                       | 202 23,34       |                    |
| 48-68556A4   |                        | Cleaver™      |                  | 992004                       | 993044          | 993024             | 993204                       | 202 23,34       |                    |
| 48-68557A4   |                        | Cleaver™ (LH) |                  |                              | 993055          | 993035             | 993215                       | 202 23,34       |                    |
| 48-68558A4   |                        | Cleaver™      |                  | 992005                       | 993045          | 993025             | 993205                       | 202 23,34       |                    |
| 48-72764A4   | .031042                | 335131        |                  | 992114                       | 993144          |                    | See Note 3                   | 22              |                    |
| 48-72764A5   | .031042                | 335131        |                  | 992114                       | 993144          |                    | See Note 3                   | 22              |                    |
| 48-73132A4   |                        | Black Max™    | .031015          |                              |                 |                    |                              | 21              |                    |
| 48-73132A40  |                        | Black Max™    | .031015          |                              |                 |                    |                              | 21              |                    |
| 48-73134A4   |                        | Black Max™    | .031016          | 992405                       | 993405          |                    | 114                          | 21              |                    |
| 48-73134A40  |                        | Black Max™    | .031016          | 992405                       | 993405          |                    | 114                          | 21              |                    |
| 48-73136A4   |                        | Black Max™    | .031017          | 395129                       | 992406          | 993406             |                              | 114 21          |                    |
| 48-73136A40  |                        | Black Max™    | .031017          | 395129                       | 992406          | 993406             |                              | 114 21          |                    |
| 48-73138A4   |                        | Black Max™    | .031018          |                              | 992407          | 993407             |                              | 114 21          |                    |
| 48-73138A40  |                        | Black Max™    | .031018          |                              | 992407          | 993407             |                              | 114 21          |                    |
| 48-73140A4   |                        | Black Max™    | .031019          | 395130                       | 992408          | 993408             |                              | 114 21          |                    |
| 48-73140A40  |                        | Black Max™    | .031019          | 395130                       | 992408          | 993408             |                              | 114 21          |                    |
| 48-73142A40  |                        | Black Max™    |                  | 992409                       |                 |                    | 114                          | 21              |                    |
| 48-73144A4   |                        | Black Max™    | .031020          |                              |                 |                    |                              | 21              |                    |
| 48-73144A40  |                        | Black Max™    | .031020          |                              |                 |                    |                              | 21              |                    |
| 48-73502A4   |                        |               | .031022          |                              |                 |                    |                              | 23,34           |                    |
| 48-73504A4   | .031023                | 345131        |                  | 992002                       | 993042          |                    | 202                          | 23,34           |                    |
| 48-73506A4   | .031024                | 345132        |                  | 992003                       | 993043          | 993023             | 993203                       | 202 23,34       |                    |
| 48-73508A4   | .031025                | 345133        |                  | 992004                       | 993044          | 993024             | 993204                       | 202 23,34       |                    |
| 48-73510A4   | .031026                | 345134        |                  | 992005                       | 993045          | 993025             | 993205                       | 202 23,34       |                    |
| 48-73512A4   |                        | 345135        |                  | 992006                       | 993046          | 993026             | 993206                       | 202 23,34       |                    |
| 48-73980A4   |                        | QSS™          | .031025          | 345133                       | 992004          | 993044             | 993024                       | 993204          | 202 23,34          |
| 48-73980A5   |                        | QSS™          | .031025          | 345133                       | 992004          | 993044             | 993024                       | 993204          | 202 23,34          |
| 48-73982A4   |                        | QSS™          | .031026          | 345134                       | 992005          | 993045             | 993025                       | 993205          | 202 23,34          |
| 48-73982A5   |                        | QSS™          | .031026          | 345134                       | 992005          | 993045             | 993025                       | 993205          | 202 23,34          |
| 48-74266A4   |                        | QSS™          | .031025          | 345133                       | 992004          | 993044             | 993024                       | 993204          | 202 23,34          |
| 48-74268A4   |                        | QSS™          | .031026          | 345134                       | 992005          | 993045             | 993025                       | 993205          | 202 23,34          |
| 48-74598A4   |                        | Cleaver™      | .031025          | 345133                       | 992004          | 993044             | 993024                       | 993204          | 202 23,34          |
| 48-74599A4   |                        | Cleaver™ (LH) |                  | 345164                       |                 | 993055             | 993035                       | 993215          | 202 23,34          |
| 48-74600A4   |                        | Cleaver™      | .031026          | 345134                       | 992005          | 993045             | 993025                       | 993205          | 202 23,34          |
| 48-74601A4   |                        | Cleaver™ (LH) |                  | 345165                       |                 | 993056             | 993036                       | 993216          | 202 23,34          |
| 48-74872A4   |                        |               | .031051          |                              | 992003          | 993043             | 993023                       | 993203          | 202 23,34          |
| 48-74874A4   |                        |               | .031052          |                              | 992004          | 993044             | 993024                       | 993204          | 202 23,34          |
| 48-74876A4   |                        |               | .031026          | 345134                       | 992005          | 993045             | 993025                       | 993205          | 202 23,34          |
| 48-74886A4   |                        |               | .031052          |                              | 992004          | 993044             | 993024                       | 993204          | 202 23,34          |
| 48-74888A4   |                        |               | .031026          | 345134                       | 992005          | 993045             | 993025                       | 993205          | 202 23,34          |
| 48-75058A4   |                        | QSS™          |                  | 345135                       | 992006          | 993046             | 993026                       | 993206          | 202 23,34          |
| 48-75160A4   |                        |               |                  | 345135                       | 992006          | 993046             | 993026                       | 993206          | 202 23,34          |
| 48-75724A4   |                        | QSS™          |                  | 345135                       | 992006          | 993046             | 993026                       | 993206          | 202 23,34          |
| 48-75724A5   |                        | QSS™          |                  | 345135                       | 992006          | 993046             | 993026                       | 993206          | 202 23,34          |
| 48-75760A4   |                        |               | .031023          | 345131                       | 992002          | 993042             |                              | 202 23,34       |                    |
| 48-76230A4   |                        | QSS™          | .031058          |                              | 992407          | 993407             |                              | 114 21          |                    |
| 48-76230A5   |                        | Vengeance     | .031058          |                              | 992407          | 993407             |                              | 114 21          |                    |
| 48-76232A4   |                        | QSS™          | .031019          | 395130                       | 992408          | 993408             |                              | 114 21          |                    |
| 48-76232A5   |                        | Vengeance     | .031019          | 395130                       | 992408          | 993408             |                              | 114 21          |                    |

\* Indicates limited quantities.

# MICHIGAN WHEEL OEM CROSS REFERENCE

| Original Equipment Manufacturer<br>Part & Trade Mark | Standard Hub Propeller |            |                  | XHS® / XHS II® Hub Propeller |                 |                    | XHS® / XHS II®<br>Hub Kit(s) | Catalog Page #s |
|--|------------------------|------------|------------------|------------------------------|-----------------|--------------------|------------------------------|-----------------|
|  | Michigan<br>Match®     | Ballistic® | Ballistic®<br>XL | Vortex®<br>XHS               | Apollo®<br>Std. | Apollo®<br>Lg. Dia |                              |                 |
| <b>MERCURY®, MARINER®, MERCUISER® (Continued)</b>    |                        |            |                  |                              |                 |                    |                              |                 |
| 48-77338A4   | Black Max™             |            |                  | 031054                       |                 |                    |                              | 22              |
| 48-77338A33  | Black Max™             |            |                  | 031054                       |                 |                    |                              | 22              |
| 48-77338A40  | Black Max™             |            |                  | 031054                       |                 |                    |                              | 22              |
| 48-77338A45  | Black Max™             |            |                  | 031054                       |                 |                    |                              | 22              |
| 48-77338CP1  | Black Max™ Pontoon     |            |                  | 031200                       |                 |                    |                              | 22              |
| 48-77340A4   | Black Max™             |            |                  | 031055                       |                 | 992112             | See Note 3                   | 22              |
| 48-77340A33  | Black Max™             |            |                  | 031055                       |                 | 992112             | See Note 3                   | 22              |
| 48-77340A40  | Black Max™             |            |                  | 031055                       |                 | 992112             | See Note 3                   | 22              |
| 48-77340A45  | Black Max™             |            |                  | 031055                       |                 | 992112             | See Note 3                   | 22              |
| 48-77340CP1  | Black Max™ Pontoon     |            |                  | 031202                       |                 |                    |                              | 22              |
| 48-77342A4   | Black Max™             |            |                  | 031041                       | 335130          | 992113             | 993143                       | See Note 3      |
| 48-77342A33  | Black Max™             |            |                  | 031041                       | 335130          | 992113             | 993143                       | See Note 3      |
| 48-77342A40  | Black Max™             |            |                  | 031041                       | 335130          | 992113             | 993143                       | See Note 3      |
| 48-77342A45  | Black Max™             |            |                  | 031041                       | 335130          | 992113             | 993143                       | See Note 3      |
| 48-77344A4   | Black Max™             |            |                  | 031042                       | 335131          | 992114             | 993144                       | See Note 3      |
| 48-77344A40  | Black Max™             |            |                  | 031042                       | 335131          | 992114             | 993144                       | See Note 3      |
| 48-77344A45  | Black Max™             |            |                  | 031042                       | 335131          | 992114             | 993144                       | See Note 3      |
| 48-77346A4   | Black Max™             |            |                  | 031043                       | 335132          | 992115             | 993145                       | See Note 3      |
| 48-77346A40  | Black Max™             |            |                  | 031043                       | 335132          | 992115             | 993145                       | See Note 3      |
| 48-77346A45  | Black Max™             |            |                  | 031043                       | 335132          | 992115             | 993145                       | See Note 3      |
| 48-77348A4   | Black Max™             |            |                  | 031044                       | 335133          | 992116             | 993146                       | See Note 3      |
| 48-77348A40  | Black Max™             |            |                  | 031044                       | 335133          | 992116             | 993146                       | See Note 3      |
| 48-77348A45  | Black Max™             |            |                  | 031044                       | 335133          | 992116             | 993146                       | See Note 3      |
| 48-77350A4   | Black Max™             |            |                  | 031045*                      |                 |                    |                              | 22              |
| 48-77350A40  | Black Max™             |            |                  | 031045*                      |                 |                    |                              | 22              |
| 48-77350A45  | Black Max™             |            |                  | 031045*                      |                 |                    |                              | 22              |
| 48-78114A4   | Black Max™             |            |                  | 031022                       |                 |                    |                              | 23,34           |
| 48-78114A40  | Black Max™             |            |                  | 031022                       |                 |                    |                              | 23,34           |
| 48-78114A45  | Black Max™             |            |                  | 031022                       |                 |                    |                              | 23,34           |
| 48-78116A4   | Black Max™             |            |                  | 031023                       | 345131          | 992002             | 993042                       | 202             |
| 48-78116A40  | Black Max™             |            |                  | 031023                       | 345131          | 992002             | 993042                       | 202             |
| 48-78116A45  | Black Max™             |            |                  | 031023                       | 345131          | 992002             | 993042                       | 202             |
| 48-78118A4   | Black Max™             |            |                  | 031024                       | 345132          | 992003             | 993043                       | 993023          |
| 48-78118A40  | Black Max™             |            |                  | 031024                       | 345132          | 992003             | 993043                       | 993023          |
| 48-78118A45  | Black Max™             |            |                  | 031024                       | 345132          | 992003             | 993043                       | 993023          |
| 48-78120A4   | Black Max™             |            |                  | 031025                       | 345133          | 992004             | 993044                       | 993024          |
| 48-78120A40  | Black Max™             |            |                  | 031025                       | 345133          | 992004             | 993044                       | 993024          |
| 48-78120A45  | Black Max™             |            |                  | 031025                       | 345133          | 992004             | 993044                       | 993024          |
| 48-78122A4   | Black Max™             |            |                  | 031026                       | 345134          | 992005             | 993045                       | 993025          |
| 48-78122A40  | Black Max™             |            |                  | 031026                       | 345134          | 992005             | 993045                       | 993025          |
| 48-78122A45  | Black Max™             |            |                  | 031026                       | 345134          | 992005             | 993045                       | 993025          |
| 48-78124A4   | Black Max™             |            |                  | 345135                       | 345137          | 992006             | 993046                       | 993026          |
| 48-78124A40  | Black Max™             |            |                  | 345135                       | 345137          | 992006             | 993046                       | 993026          |
| 48-78124A45  | Black Max™             |            |                  | 345135                       | 345137          | 992006             | 993046                       | 993026          |
| 48-78126A4   | Black Max™             |            |                  | 345136                       | 345138          |                    |                              |                 |
| 48-78126A40  | Black Max™             |            |                  | 345136                       | 345138          |                    |                              |                 |
| 48-78126A45  | Black Max™             |            |                  | 345136                       | 345138          |                    |                              |                 |
| 48-79572A4   | Black Max™             |            |                  | 031051                       | 345132          | 992003             | 993043                       | 993023          |
| 48-79574A4   | Black Max™             |            |                  | 031025                       | 345133          | 992004             | 993044                       | 993024          |
| 48-79576A4   | Black Max™             |            |                  | 031026                       | 345134          | 992005             | 993045                       | 993025          |
| 48-76578A4   | Black Max™             |            |                  | 345135                       |                 | 992006             | 993046                       | 993026          |
| 48-79792A4   | QSS™                   |            |                  | 031016                       |                 | 992405             | 993405                       | 114             |
| 48-79792A5   | Vengeance              |            |                  | 031016                       |                 | 992405             | 993405                       | 114             |
| 48-79794A4   | QSS™                   |            |                  | 031024                       |                 | 992003             | 993043                       | 993023          |
| 48-79794A5   | QSS™                   |            |                  | 031024                       |                 | 992003             | 993043                       | 993023          |
| 48-71645M  |                        |            |                  | 022002                       |                 |                    |                              | 19              |
| 48-81647M  |                        |            |                  | 022001                       |                 |                    |                              | 19              |
| 48-81649M  |                        |            |                  | 022002                       |                 |                    |                              | 19              |
| 48-816702A40   | Black Max™             |            |                  | 031056                       |                 | 992405             | 993405                       | 114             |
| 48-816704A40   | Black Max™             |            |                  | 031057                       | 395129          | 992406             | 993406                       | 114             |
| 48-816706A40   | Black Max™             |            |                  | 031058                       |                 | 992407             | 993407                       | 114             |
| 48-825860A47   |                        |            |                  | 031025                       | 345133          | 992004             | 993044                       | 993024          |
| 48-825861A47   | Tempest Plus (LH)      |            |                  | 345163                       |                 | 993054             | 993034                       | 993214          |
| 48-825862A47   | Tempest Plus           |            |                  | 031026                       | 345134          | 992005             | 993045                       | 993025          |
| 48-825863A47   | Tempest Plus (LH)      |            |                  | 345164                       |                 | 993055             | 993035                       | 993215          |
| 48-825864A47   | Tempest Plus           |            |                  | 345135                       |                 | 992006             | 993046                       | 993026          |

\* Indicates limited quantities.

# MICHIGAN WHEEL OEM CROSS REFERENCE

| Original Equipment Manufacturer<br>Part & Trade Mark | Standard Hub Propeller |            |                  | XHS® / XHS II® Hub Propeller |                 |                    | XHS® / XHS II®<br>Hub Kit(s) | Catalog Page #s |                    |
|--|------------------------|------------|------------------|------------------------------|-----------------|--------------------|------------------------------|-----------------|--------------------|
|  | Michigan<br>Match®     | Ballistic® | Ballistic®<br>XL | Vortex®<br>XHS               | Apollo®<br>Std. | Apollo®<br>Lg. Dia |                              |                 | Apollo®<br>4-Blade |
| <b>MERCURY®, MARINER®, MERCUISER® (Continued)</b>    |                        |            |                  |                              |                 |                    |                              |                 |                    |
| 48-825865A47   | Tempest Plus (LH)      |            | 345165           |                              | 993056          | 993036             | 993216                       | 202             | 23,34              |
| 48-825866A47   | Tempest Plus           |            | 345136           |                              |                 |                    |                              |                 | 23,34              |
| 48-825872A47   | Tempest Plus           |            |                  | 345137                       |                 |                    |                              |                 | 23,34              |
| 48-825874A47   | Tempest Plus           |            |                  | 345138                       |                 |                    |                              |                 | 23,34              |
| 48-825898A48   | VenSura® 4             |            |                  | 992202                       |                 |                    | 993203                       | 202             | 23,34              |
| 48-825899A48   | VenSura® 4 (LH)        |            |                  |                              |                 |                    | 993213                       | 202             | 23,34              |
| 48-825900A48   | VenSura® 4             |            |                  | 992203                       |                 |                    | 993204                       | 202             | 23,34              |
| 48-825901A48   | VenSura® 4 (LH)        |            |                  |                              |                 |                    | 993214                       | 202             | 23,34              |
| 48-825902A48   | VenSura® 4             |            |                  | 992204                       |                 |                    | 993205                       | 202             | 23,34              |
| 48-825903A48   | VenSura® 4 (LH)        |            |                  |                              |                 |                    | 993215                       | 202             | 23,34              |
| 48-825906A48   | VenSura® 4             |            |                  |                              |                 |                    | 993206                       | 202             | 23,34              |
| 48-825907A48   | VenSura® 4 (LH)        |            |                  |                              |                 |                    | 993216                       | 202             | 23,34              |
| 48-825938A47   | Trophy Plus 4          |            | 435135           |                              |                 |                    |                              |                 | 23                 |
| 48-825942A47   | Trophy Plus 4          |            | 435136           |                              |                 |                    |                              |                 | 23                 |
| 48-825946A47   | Trophy Plus 4          |            | 435137           |                              |                 |                    |                              |                 | 23                 |
| 48-827312A11   | Black Max™             | 032142     |                  |                              |                 |                    |                              |                 | 21                 |
| 48-82767   |                        | 012102     |                  |                              |                 |                    |                              |                 | 19                 |
| 48-82768   |                        | 012011     |                  |                              |                 |                    |                              |                 | 19                 |
| 48-828152A12   | Black Max™             | 032056     |                  |                              |                 |                    |                              |                 | 18                 |
| 48-828156A12   | Black Max™             | 032052     |                  |                              |                 |                    |                              |                 | 18                 |
| 48-828158A12   | Black Max™             | 032050     |                  |                              |                 |                    |                              |                 | 18                 |
| 48-82826   |                        | 022003     |                  |                              |                 |                    |                              |                 | 19                 |
| 48-832828A45   | Black Max™             | 031064     | 345132           | 992003                       | 993043          | 993023             | 993203                       | 202             | 23,34              |
| 48-832830A45   | Black Max™             | 031065     | 345133           | 992004                       | 993044          | 993024             | 993204                       | 202             | 23,34              |
| 48-832832A45   | Black Max™             | 031066     | 345134           | 992005                       | 993045          | 993025             | 993205                       | 202             | 23,34              |
| 48-832834A45   | Black Max™             |            | 345135           | 992006                       | 993046          | 993026             | 993206                       | 202             | 23,34              |
| 48-834850A45   | Alpha 4®               |            |                  | 992202                       |                 |                    | 993203                       | 202             | 23,34              |
| 48-834851A45   | Alpha 4® (LH)          |            |                  |                              |                 |                    | 993213                       | 202             | 23,34              |
| 48-834852A45   | Alpha 4®               |            |                  | 992203                       |                 |                    | 993204                       | 202             | 23,34              |
| 48-834853A45   | Alpha 4® (LH)          |            |                  |                              |                 |                    | 993214                       | 202             | 23,34              |
| 48-834854A45   | Alpha 4®               |            |                  | 992204                       |                 |                    | 993205                       | 202             | 23,34              |
| 48-834855A45   | Alpha 4® (LH)          |            |                  |                              |                 |                    | 993215                       | 202             | 23,34              |
| 48-854342A45   |                        | 031061     |                  | 992109                       |                 |                    |                              | See Note 3      | 22                 |
| 48-854354A46   | Vengeance              | 031041     | 335130           | 992113                       | 993143          |                    |                              | See Note 3      | 22                 |
| 48-855856A5  | Vengeance              |            |                  | 992405                       | 993405          |                    |                              | 114             | 21                 |
| 48-855858A5  | Vengeance              |            | 395129           | 992406                       | 993406          |                    |                              | 114             | 21                 |
| 48-855860A5  | Vengeance              |            |                  |                              | 993407          |                    |                              | 114             | 21                 |
| 48-855862A5  | Vengeance              |            | 395130           |                              | 993408          |                    |                              | 114             | 21                 |
| 48-85632A4   | Black Max™             | 031053     |                  | 992404                       |                 |                    |                              | 114             | 21                 |
| 48-85632A40  | Black Max™             | 031053     |                  | 992404                       |                 |                    |                              | 114             | 21                 |
| 48-86848A4   |                        | 031048     |                  |                              |                 |                    |                              |                 | 19                 |
| 48-86962A4   |                        | 032136     |                  |                              |                 |                    |                              |                 | 18                 |
| 48-88438A4   | QSS™                   |            |                  |                              | 993043          |                    | 993203                       | 202             | 23,34              |
| 48-88440A4   | QSS™                   |            |                  |                              | 993044          |                    | 993204                       | 202             | 23,34              |
| 48-88442A4   | QSS™                   |            |                  |                              | 993045          |                    | 993205                       | 202             | 23,34              |
| 48-88444A4   | QSS™                   |            |                  |                              | 993046          |                    | 993206                       | 202             | 23,34              |
| 48-896890A10   | Black Max™             | 142020     |                  |                              |                 |                    |                              |                 | 20                 |
| 48-896892A40   | Black Max™             |            |                  | 992501                       |                 |                    |                              | 122             | 20                 |
| 48-896896A40   | Black Max™             |            |                  | 992503                       |                 |                    |                              | 122             | 20                 |
| 48-897618A10   | Black Max™             | 142017     |                  |                              |                 |                    |                              |                 | 18                 |
| 48-89852A4   |                        | 031049     |                  | 992503                       |                 |                    |                              | 120             | 19                 |
| 48-89854A4   |                        |            |                  | 992506                       |                 |                    |                              | 120             | 19                 |
| 48-898990A46   | Enertia®               | 031023     | 345131           | 992002                       | 993042          |                    |                              | 202             | 23,34              |
| 48-898991A46   | Enertia® (LH)          |            |                  |                              | 993052          |                    |                              | 202             | 23,34              |
| 48-898994A46   | Enertia®               | 031024     | 345132           | 992003                       | 993043          | 993023             | 993203                       | 202             | 23,34              |
| 48-898995A46   | Enertia® (LH)          |            | 345162           |                              | 993053          | 993033             | 993213                       | 202             | 23,34              |
| 48-898998A46   | Enertia®               | 031025     | 345133           | 992004                       | 993044          | 993024             | 993204                       | 202             | 23,34              |
| 48-898999A46   | Enertia® (LH)          |            | 345163           |                              | 993054          | 993034             | 993214                       | 202             | 23,34              |
| 48-899002A46   | Enertia®               | 031026     | 345134           | 992005                       | 993045          | 993025             | 993205                       | 202             | 23,34              |
| 48-899003A46   | Enertia® (LH)          |            | 345164           |                              | 993055          | 993035             | 993215                       | 202             | 23,34              |
| 48-899004A46   | Laser II™              | 031043     | 335132           | 992115                       | 993145          |                    |                              | 202             | 22                 |
| 48-899006A46   | Laser II™              | 031044     | 335133           | 992116                       | 993146          |                    |                              | 202             | 22                 |
| 48-90159A46  |                        |            | 345162           |                              | 993053          | 993033             | 993213                       | 202             | 23,34              |
| 48-93272A4   | QSS™                   | 031023     | 345131           | 992002                       | 993042          |                    |                              | 202             | 23,34              |
| 48-93272A5   | QSS™                   | 031023     | 345131           | 992002                       | 993042          |                    |                              | 202             | 23,34              |
| 48-96623M  |                        | 012013     |                  |                              |                 |                    |                              |                 | 19                 |

# MICHIGAN WHEEL OEM CROSS REFERENCE

| Original Equipment Manufacturer<br>Part & Trade Mark | Standard Hub Propeller |            |                  | XHS® / XHS II® Hub Propeller |                 |                    |                    | XHS® / XHS II®<br>Hub Kit(s) | Catalog Page #s |
|--|------------------------|------------|------------------|------------------------------|-----------------|--------------------|--------------------|------------------------------|-----------------|
|  | Michigan<br>Match®     | Ballistic® | Ballistic®<br>XL | Vortex®<br>XHS               | Apollo®<br>Std. | Apollo®<br>Lg. Dia | Apollo®<br>4-Blade |                              |                 |
| <b>MERCURY®, MARINER®, MERCUISER® (Continued)</b>    |                        |            |                  |                              |                 |                    |                    |                              |                 |
| 48-96625M  |                        |            |                  | .012011                      |                 |                    |                    |                              | 19              |
| 48-96628M  |                        |            |                  | .012102                      |                 |                    |                    |                              | 19              |
| QA1912X  | Black Diamond®         | .031064    | 345132           | .992003                      | 993043          | .993023            | 993203             | 202                          | 23,34           |
| QA1916X  | Black Diamond®         | .031065    | 345133           | .992004                      | 993044          | .993024            | 993204             | 202                          | 23,34           |
| QA1918X  | Black Diamond®         | .031066    | 345134           | .992005                      | 993045          | .993025            | 993205             | 202                          | 23,34           |
| QA1920X  | Black Diamond®         |            | 345135           | .992006                      | 993046          | .993026            | 993206             | 202                          | 23,34           |
| QA2004X  | Black Diamond®         | .031022    |                  |                              |                 |                    |                    |                              | 23,34           |
| QA2006X  | Black Diamond®         | .031050    | 345131           | .992002                      | 993042          |                    |                    | 202                          | 23,34           |
| QA2008X  | Black Diamond®         | .031023    | 345131           | .992002                      | 993042          |                    |                    | 202                          | 23,34           |
| QA2010X  | Black Diamond®         | .031051    | 345132           | .992003                      | 993043          | .993023            | 993203             | 202                          | 23,34           |
| QA2012X  | Black Diamond®         | .031024    | 345132           | .992003                      | 993043          | .993023            | 993203             | 202                          | 23,34           |
| QA2014X  | Black Diamond®         | .031052    | 345133           | .992004                      | 993044          | .993024            | 993204             | 202                          | 23,34           |
| QA2016X  | Black Diamond®         | .031025    | 345133           | .992004                      | 993044          | .993024            | 993204             | 202                          | 23,34           |
| QA2018X  | Black Diamond®         | .031026    | 345134           | .992005                      | 993045          | .993025            | 993205             | 202                          | 23,34           |
| QA2022X  | Black Diamond®         |            | 345136           |                              |                 |                    |                    |                              | 23,34           |
| QA2028X  | Black Diamond®         | .031043    | 335132           | .992115                      | 993145          |                    |                    | See Note 3                   | 22              |
| QA2030X  | Black Diamond®         | .031054    |                  |                              |                 |                    |                    |                              | 22              |
| QA2032X  | Black Diamond®         | .031055    |                  | .992112                      |                 |                    |                    | See Note 3                   | 22              |
| QA2034X  | Black Diamond®         | .031041    | 335130           | .992113                      | 993143          |                    |                    | See Note 3                   | 22              |
| QA2036X  | Black Diamond®         | .031042    | 335131           | .992114                      | 993144          |                    |                    | See Note 3                   | 22              |
| QA2038X  | Black Diamond®         | .031043    | 335132           | .992115                      | 993145          |                    |                    | See Note 3                   | 22              |
| QA2040X  | Black Diamond®         | .031044    | 335133           | .992116                      | 993146          |                    |                    | See Note 3                   | 22              |
| QA2042X  | Black Diamond®         | .031045*   |                  |                              |                 |                    |                    |                              | 22              |
| QA2060R  | Black Diamond®         | .032141    |                  |                              |                 |                    |                    |                              | 21              |
| QA2064R  | Black Diamond®         | .032044    |                  | .992404                      |                 |                    |                    | 114                          | 20              |
| QA2064R  | Black Diamond®         | .031015    |                  | .992404                      |                 |                    |                    | 114                          | 20              |
| QA2066R  | Black Diamond®         | .032142    |                  |                              |                 |                    |                    |                              | 20              |
| QA2070R  | Black Diamond®         | .031053    |                  | .992404                      |                 |                    |                    | 114                          | 21              |
| QA2072R  | Black Diamond®         | .031056    |                  | .992405                      | 993405          |                    |                    | 114                          | 21              |
| QA2074R  | Black Diamond®         | .031016    |                  | .992405                      | 993405          |                    |                    | 114                          | 21              |
| QA2078R  | Black Diamond®         | .032043    |                  | .992405                      | 993405          |                    |                    | 114                          | 20              |
| QA2078R  | Black Diamond®         | .031017    | 395129           | .992406                      | 993406          |                    |                    | 114                          | 21              |
| QA2078R  | Black Diamond®         | .032042    | 395929           | .992406                      | 993406          |                    |                    | 114                          | 20              |
| QA2080R  | Black Diamond®         | .031058    |                  | .992407                      | 993407          |                    |                    | 114                          | 21              |
| QA2082R  | Black Diamond®         | .031018    | 395130           | .992407                      | 993407          |                    |                    | 114                          | 21              |
| QA2082R  | Black Diamond®         | .032041    |                  | .992407                      | 993407          |                    |                    | 114                          | 20              |
| QA2084R  | Black Diamond®         | .031019    | 395130           | .992408                      | 993408          |                    |                    | 114                          | 21              |
| QA2084R  | Black Diamond®         | .032040    | 395930           | .992408                      | 993408          |                    |                    | 114                          | 20              |
| QA2088R  | Black Diamond®         | .031020    |                  |                              |                 |                    |                    |                              | 21              |
| QA2102R  | Black Diamond®         | .031049    |                  | .992503                      |                 |                    |                    | 120                          | 19              |
| QA2106R  | Black Diamond®         | .031048    | 305129           | .992505                      |                 |                    |                    | 120                          | 19              |
| QA2108R  | Black Diamond®         |            | 305130           | .992506                      |                 |                    |                    | 120                          | 19              |
| QA2124R  | Black Diamond®         | .032056    |                  |                              |                 |                    |                    |                              | 18              |
| QA2128R  | Black Diamond®         | .032052    |                  |                              |                 |                    |                    |                              | 18              |
| QA2130R  | Black Diamond®         | .032050    |                  |                              |                 |                    |                    |                              | 18              |
| QA2158R  | Black Diamond®         | .142017    |                  |                              |                 |                    |                    |                              | 18              |
| QA2182X  | Diamond 4              |            |                  | .992202                      | 993043          | .993023            | 993203             | 202                          | 23,34           |
| QA2183X  | Diamond 4 (LH)         |            |                  |                              | 993053          | .993033            | 993213             | 202                          | 23,34           |
| QA2184X  | Diamond 4              |            |                  | .992203                      | 993044          | .993024            | 993204             | 202                          | 23,34           |
| QA2185X  | Diamond 4 (LH)         |            |                  |                              | 993054          | .993034            | 993214             | 202                          | 23,34           |
| QA2186X  | Diamond 4              |            |                  | .992204                      | 993045          | .993025            | 993205             | 202                          | 23,34           |
| QA2187X  | Diamond 4 (LH)         |            |                  |                              | 993055          | .993035            | 993215             | 202                          | 23,34           |
| QA2190R  | Black Diamond®         | .142020    |                  |                              |                 |                    |                    |                              | 20              |
| QA2226R  | Black Diamond®         | .032044    |                  | .992603                      | 993405          |                    |                    | 114                          | 20              |
| QA2230R  | Black Diamond®         | .032042    | 395929           | .992605                      | 993406          |                    |                    | 114                          | 20              |
| QA2232R  | Black Diamond®         | .032041    |                  | .992606                      | 993407          |                    |                    | 114                          | 20              |
| QA2234R  | Black Diamond®         | .032040    | 395930           | .992408                      | 993408          |                    |                    | 114                          | 20              |
| QA2830X  | Black Diamond®         | .031200    |                  |                              |                 |                    |                    |                              | 22              |
| QA2832X  | Black Diamond®         | .031202    |                  |                              |                 |                    |                    |                              | 22              |
| QA3150R  | Black Diamond®         | .012011    |                  |                              |                 |                    |                    |                              | 19              |
| QA3808R  | Black Diamond®         | .022002    |                  |                              |                 |                    |                    |                              | 19              |
| QA3812R  | Black Diamond®         | .022003    |                  |                              |                 |                    |                    |                              | 19              |
| QA6004   | QA3                    | .031022    |                  |                              |                 |                    |                    |                              | 23,34           |
| QA6010   | QA3                    | .031051    |                  |                              |                 |                    |                    |                              | 23,34           |
| QA6012   | QA3                    | .031024    | 345132           | .992003                      | 993043          | .993023            | 993203             | 202                          | 23,34           |
| QA6016   | QA3                    | .031025    | 345133           | .992004                      | 993044          | .993024            | 993204             | 202                          | 23,34           |

\* Indicates limited quantities.

# MICHIGAN WHEEL OEM CROSS REFERENCE

| Original Equipment Manufacturer<br>Part & Trade Mark |                   | Standard Hub Propeller |            |                  | XHS® / XHS II® Hub Propeller |                 |                    | XHS® / XHS II®<br>Hub Kit(s) | Catalog Page #s |                    |
|--|-------------------|------------------------|------------|------------------|------------------------------|-----------------|--------------------|------------------------------|-----------------|--------------------|
|  |                   | Michigan<br>Match®     | Ballistic® | Ballistic®<br>XL | Vortex®<br>XHS               | Apollo®<br>Std. | Apollo®<br>Lg. Dia |                              |                 | Apollo®<br>4-Blade |
| <b>MERCURY®, MARINER®, MERCURISER® (Continued)</b>   |                   |                        |            |                  |                              |                 |                    |                              |                 |                    |
| QA6018   | QA3               | 031026                 | 345134     |                  | 992005                       | 993045          | 993025             | 993205                       | 202             | 23,34              |
| QA6020   | QA3               |                        | 345135     |                  | 992006                       | 993046          | 993026             | 993206                       | 202             | 23,34              |
| QA6030   | QA3               | 031054                 |            |                  |                              |                 |                    |                              |                 | 22                 |
| QA6032   | QA3               | 031055                 |            |                  | 992112                       |                 |                    |                              | See Note 3      | 22                 |
| QA6034   | QA3               | 031041                 |            |                  | 992113                       | 993143          |                    |                              | See Note 3      | 22                 |
| QA6036   | QA3               | 031042                 |            |                  | 992114                       | 993144          |                    |                              | See Note 3      | 22                 |
| QA6038   | QA3               | 031043                 |            |                  | 992115                       | 993145          |                    |                              | See Note 3      | 22                 |
| QA6040   | QA3               | 031044                 |            |                  | 992116                       | 993146          |                    |                              | See Note 3      | 22                 |
| QA6042   | QA3               | 031045*                |            |                  |                              |                 |                    |                              |                 | 22                 |
| QA6060T  | QA3               | 032141                 |            |                  |                              |                 |                    |                              |                 | 21                 |
| QA6064T  | QA3               | 031015                 |            |                  |                              |                 |                    |                              |                 | 21                 |
| QA6070T  | QA3               | 031053                 |            |                  | 992404                       |                 |                    |                              | 114             | 21                 |
| QA6074T  | QA3               | 031016                 |            |                  | 992405                       | 993405          |                    |                              | 114             | 21                 |
| QA6078T  | QA3               | 031017                 |            |                  | 992406                       | 993406          |                    |                              | 114             | 21                 |
| QA6082T  | QA3               | 031018                 |            |                  | 992407                       | 993407          |                    |                              | 114             | 21                 |
| QA6084T  | QA3               | 031019                 |            |                  | 992408                       | 993408          |                    |                              | 114             | 21                 |
| QA6102T  | QA3               | 031049                 |            |                  | 992503                       |                 |                    |                              | 120             | 19                 |
| QA6106T  | QA3               | 031048                 | 305129     |                  | 992505                       |                 |                    |                              | 120             | 19                 |
| QA6128T  | QA3               | 032021                 |            |                  |                              |                 |                    |                              |                 | 18                 |
| QS5004X  | Thunderbolt       | 031064                 | 345132     |                  | 992003                       | 993043          | 993023             | 993203                       | 202             | 23,34              |
| QS5005X  | Thunderbolt (LH)  |                        | 345162     |                  |                              | 993053          | 993033             | 993213                       | 202             | 23,34              |
| QS5006X  | Thunderbolt       | 031065                 | 345133     |                  | 992004                       | 993044          | 993024             | 993204                       | 202             | 23,34              |
| QS5007X  | Thunderbolt (LH)  |                        | 345163     |                  |                              | 993054          | 993034             | 993214                       | 202             | 23,34              |
| QS5008X  | Thunderbolt       | 031066                 | 345134     |                  | 992005                       | 993045          | 993025             | 993205                       | 202             | 23,34              |
| QS5009X  | Thunderbolt (LH)  |                        | 345164     |                  |                              | 993055          | 993035             | 993215                       | 202             | 23,34              |
| QS5010X  | Thunderbolt       |                        | 345135     |                  | 992006                       | 993046          | 993026             | 993206                       | 202             | 23,34              |
| QS5011X  | Thunderbolt (LH)  |                        | 345165     |                  |                              | 993056          | 993036             | 993216                       | 202             | 23,34              |
| QS5050X  | Silverado         | 031023                 | 345131     |                  | 992002                       | 993042          |                    |                              | 202             | 23,34              |
| QS5052X  | Silverado         | 031024                 | 345132     |                  | 992003                       | 993043          | 993023             | 993203                       | 202             | 23,34              |
| QS5053X  | Silverado (LH)    |                        | 345162     |                  |                              | 993053          | 993033             | 993213                       | 202             | 23,34              |
| QS5054X  | Silverado         | 031025                 | 345133     |                  | 992004                       | 993044          | 993024             | 993204                       | 202             | 23,34              |
| QS5055X  | Silverado (LH)    |                        | 345163     |                  |                              | 993054          | 993034             | 993214                       | 202             | 23,34              |
| QS5056X  | Silverado         | 031026                 | 345134     |                  | 992005                       | 993045          | 993025             | 993205                       | 202             | 23,34              |
| QS5057X  | Silverado (LH)    |                        | 345164     |                  |                              | 993055          | 993035             | 993215                       | 202             | 23,34              |
| QS5058X  | Silverado         |                        | 345135     |                  | 992006                       | 993046          | 993026             | 993206                       | 202             | 23,34              |
| QS5059X  | Silverado (LH)    |                        | 345165     |                  |                              | 993056          | 993036             | 993216                       | 202             | 23,34              |
| QS5070X  | Lightspeed        | 031025                 | 345133     |                  | 992004                       | 993044          | 993024             | 993204                       | 202             | 23,34              |
| QS5071X  | Lightspeed (LH)   |                        | 345163     |                  |                              | 993054          | 993034             | 993214                       | 202             | 23,34              |
| QS5072X  | Lightspeed        | 031016                 | 345134     |                  | 992005                       | 993045          | 993025             | 993205                       | 202             | 23,34              |
| QS5073X  | Lightspeed (LH)   |                        | 345164     |                  |                              | 993055          | 993035             | 993215                       | 202             | 23,34              |
| QS5074X  | Lightspeed        |                        | 345135     | 345141           | 992006                       | 993046          | 993026             | 993206                       | 202             | 23,34              |
| QS5075X  | Lightspeed (LH)   |                        | 345165     |                  |                              | 993056          | 993036             | 993216                       | 202             | 23,34              |
| QS5116X  | Silverado         | 031041                 | 335130     |                  | 992113                       | 993143          |                    |                              | 202             | 22                 |
| QS5118X  | Silverado         | 031042                 | 335131     |                  | 992114                       | 993144          |                    |                              | 202             | 22                 |
| QS5120X  | Silverado         | 031043                 | 335132     |                  | 992115                       | 993145          |                    |                              | 202             | 22                 |
| QS5122X  | Silverado         | 031044                 | 335133     | 335134           | 992116                       | 993146          |                    |                              | 202             | 22                 |
| QS5124X  | Silverado         |                        | 335135     |                  |                              |                 |                    |                              |                 | 22                 |
| QS5164R  | Silverado         | 031056                 |            |                  | 992405                       | 993405          |                    |                              | 114             | 21                 |
| QS5166R  | Silverado         | 031057                 | 395129     |                  | 992406                       | 993406          |                    |                              | 114             | 21                 |
| QS5168R  | Silverado         | 031058                 | 395130     |                  | 992407                       | 993407          |                    |                              | 114             | 21                 |
| QS5170R  | Silverado         | 031058                 | 395130     |                  | 992408                       | 993407          |                    |                              | 114             | 21                 |
| QS5180R  | Silverado         | 031048                 | 305129     |                  | 992505                       |                 |                    |                              | 120             | 19                 |
| QS5862X  | Torrent           | 031066                 | 345143     |                  | 992005                       | 993045          | 993025             | 993205                       | 202             | 23,34              |
| QS5864X  | Torrent           |                        | 345135     |                  | 992006                       | 993046          | 993026             | 993206                       | 202             | 23,34              |
| QS6003X  | Typhoon® 4 (LH)   |                        |            |                  |                              |                 |                    | 993214                       | 202             | 23,34              |
| QS6004X  | Typhoon® 4        |                        |            |                  |                              |                 |                    | 993204                       | 202             | 23,34              |
| QS6005X  | Typhoon® 4 (LH)   |                        |            |                  |                              |                 |                    | 993215                       | 202             | 23,34              |
| QS6006X  | Typhoon® 4        |                        |            |                  |                              |                 |                    | 993205                       | 202             | 23,34              |
| TA1916X  | Black Diamond® XT | 031065                 | 345133     |                  | 992004                       | 993044          | 993024             | 993204                       | 202             | 23,34              |
| TA1918X  | Black Diamond® XT | 031066                 | 345134     |                  | 992005                       | 993045          | 993025             | 993205                       | 202             | 23,34              |
| TA1920X  | Black Diamond® XT |                        | 345135     |                  | 992006                       | 993046          | 993026             | 993206                       | 202             | 23,34              |
| TA2004X  | Black Diamond®    | 031022                 |            |                  |                              |                 |                    |                              |                 | 23,34              |
| TA2008   | Black Diamond®    | 031023                 |            |                  | 992002                       | 993042          |                    |                              | 202             | 23,34              |
| TA2010   | Black Diamond®    | 031051                 |            |                  | 992003                       | 993043          | 993023             | 993203                       | 202             | 23,34              |
| TA2012   | Black Diamond®    | 031024                 |            |                  | 992003                       | 993043          | 993023             | 993203                       | 202             | 23,34              |
| TA2014   | Black Diamond®    | 031052                 |            |                  | 992004                       | 993044          | 993024             | 993204                       | 202             | 23,34              |

\* Indicates limited quantities.



# MICHIGAN WHEEL OEM CROSS REFERENCE

| Original Equipment Manufacturer<br>Part & Trade Mark |                  | Standard Hub Propeller |            |                  | XHS® / XHS II® Hub Propeller |                 |                    | XHS® / XHS II®<br>Hub Kit(s) | Catalog Page #s |                    |
|--|------------------|------------------------|------------|------------------|------------------------------|-----------------|--------------------|------------------------------|-----------------|--------------------|
|  |                  | Michigan<br>Match®     | Ballistic® | Ballistic®<br>XL | Vortex®<br>XHS               | Apollo®<br>Std. | Apollo®<br>Lg. Dia |                              |                 | Apollo®<br>4-Blade |
| <b>MERCURY®, MARINER®, MERCURISER® (Continued)</b>   |                  |                        |            |                  |                              |                 |                    |                              |                 |                    |
| TA2016   | Black Diamond®   | .031025                |            |                  | .992004                      | .993044         | .993024            | .993204                      | 202             | 23,34              |
| TA2018   | Black Diamond®   | .031026                |            |                  | .992005                      | .993045         | .993025            | .993205                      | 202             | 23,34              |
| TA2020   | Black Diamond®   |                        |            |                  | .992006                      | .993046         | .993026            | .993206                      | 202             | 23,34              |
| TA2030X  | Black Diamond®   | .031054                |            |                  |                              |                 |                    |                              |                 | 22                 |
| TA2032X  | Black Diamond®   | .031055                |            |                  |                              |                 |                    |                              |                 | 22                 |
| TA2034   | Black Diamond®   | .031041                | 335130     |                  | .992113                      | .993143         |                    |                              | See Note 3      | 22                 |
| TA2036   | Black Diamond®   | .031042                | 335131     |                  | .992115                      | .993144         |                    |                              | See Note 3      | 22                 |
| TA2038   | Black Diamond®   | .031043                | 335132     |                  | .992115                      | .993145         |                    |                              | See Note 3      | 22                 |
| TA2040   | Black Diamond®   | .031044                | 335133     |                  | .992116                      | .993146         |                    |                              | See Note 3      | 22                 |
| TA2048   | Black Diamond®   | .031041                | 335130     |                  | .992113                      | .993143         |                    |                              | See Note 3      | 22                 |
| TA2050   | Black Diamond®   | .031042                | 335131     |                  | .992114                      | .993144         |                    |                              | See Note 3      | 22                 |
| TA2052   | Black Diamond®   | .031043                | 335132     |                  | .992115                      | .993145         |                    |                              | See Note 3      | 22                 |
| TA2054   | Black Diamond®   | .031044                | 335133     |                  | .992116                      | .993146         |                    |                              | See Note 3      | 22                 |
| TA2060T  | Black Diamond®   | .032141                |            |                  |                              |                 |                    |                              |                 | 21                 |
| TA2064T  | Black Diamond®   | .031015                |            |                  |                              |                 |                    |                              |                 | 21                 |
| TA2066T  | Black Diamond®   | .032142                |            |                  |                              |                 |                    |                              |                 | 21                 |
| TA2070T  | Black Diamond®   | .031053                |            |                  | .992404                      |                 |                    |                              | 114             | 21                 |
| TA2072T  | Black Diamond®   | .031056                |            |                  | .992405                      | .993405         |                    |                              | 114             | 21                 |
| TA2074T  | Black Diamond®   | .031016                |            |                  | .992405                      | .993405         |                    |                              | 114             | 21                 |
| TA2076T  | Black Diamond®   | .031057                | 395129     |                  | .992406                      | .993406         |                    |                              | 114             | 21                 |
| TA2078T  | Black Diamond®   | .031017                | 395129     |                  | .992406                      | .993406         |                    |                              | 114             | 21                 |
| TA2080T  | Black Diamond®   | .031058                |            |                  | .992407                      | .993407         |                    |                              | 114             | 21                 |
| TA2082T  | Black Diamond®   | .031018                |            |                  | .992407                      | .993407         |                    |                              | 114             | 21                 |
| TA2084T  | Black Diamond®   | .031019                | 395130     |                  | .992408                      | .993408         |                    |                              | 114             | 21                 |
| TA2088T  | Black Diamond®   | .031022                |            |                  |                              |                 |                    |                              |                 | 23,34              |
| TA2106T  | Black Diamond®   | .031048                |            |                  | .992505                      |                 |                    |                              | 202             | 19                 |
| TA2128T  | Black Diamond®   | .032052                |            |                  |                              |                 |                    |                              |                 | 19                 |
| TA2202   | Black Diamond®   | .031044                | 335133     |                  | .992116                      | .993146         |                    |                              | See Note 3      | 22                 |
| TA2204   | Black Diamond®   | .031043                | 335132     |                  | .992115                      | .993145         |                    |                              | See Note 3      | 22                 |
| TA2206   | Black Diamond®   | .031042                | 335131     |                  | .992114                      | .993144         |                    |                              | See Note 3      | 22                 |
| TA2208   | Black Diamond®   | .031041                | 335130     |                  | .992113                      | .993143         |                    |                              | See Note 3      | 22                 |
| TA3150T  | Black Diamond®   | .012011                |            |                  |                              |                 |                    |                              |                 | 19                 |
| TA3152T  | Black Diamond®   | .012013                |            |                  |                              |                 |                    |                              |                 | 19                 |
| TA3808T  | Black Diamond®   | .022002                |            |                  |                              |                 |                    |                              |                 | 19                 |
| TS1006   | Thunderbolt      |                        |            |                  | .992004                      | .993044         | .993024            | .993204                      | 202             | 23,34              |
| TS1007   | Thunderbolt (LH) |                        |            |                  |                              | .993054         | .993034            | .993214                      | 202             | 23,34              |
| TS1008   | Thunderbolt      |                        |            |                  | .992005                      | .993045         | .993025            | .993205                      | 202             | 23,34              |
| TS1009   | Thunderbolt (LH) |                        |            |                  |                              | .993055         | .993035            | .993215                      | 202             | 23,34              |
| TS1010   | Thunderbolt      |                        |            |                  | .992006                      | .993046         | .993026            | .993206                      | 202             | 23,34              |
| TS1011   | Thunderbolt (LH) |                        |            |                  |                              | .993056         | .993036            | .993216                      | 202             | 23,34              |
| TS1052   | Silverado        | .031064                | 345132     |                  | .992003                      | .993043         | .993023            | .993203                      | 202             | 23,34              |
| TS1053   | Silverado (LH)   |                        | 345162     |                  |                              | .993053         | .993033            | .993213                      | 202             | 23,34              |
| TS1054   | Silverado        | .031065                | 345133     |                  | .992004                      | .993044         | .993024            | .993204                      | 202             | 23,34              |
| TS1055   | Silverado (LH)   |                        | 345163     |                  |                              | .993054         | .993034            | .993214                      | 202             | 23,34              |
| TS1056   | Silverado        | .031066                | 345134     |                  | .992005                      | .993045         | .993025            | .993205                      | 202             | 23,34              |
| TS1057   | Silverado (LH)   |                        | 345164     |                  |                              | .993055         | .993035            | .993215                      | 202             | 23,34              |
| TS1070   | Lightspeed       | .031065                | 345133     |                  | .992004                      | .993044         | .993024            | .993204                      | 202             | 23,34              |
| TS1071   | Lightspeed (LH)  |                        | 345163     |                  |                              | .993054         | .993034            | .993214                      | 202             | 23,34              |
| TS1072   | Lightspeed       | .031066                | 345134     |                  | .992005                      | .993045         | .993025            | .993205                      | 202             | 23,34              |
| TS1073   | Lightspeed (LH)  |                        | 345164     |                  |                              | .993055         | .993035            | .993215                      | 202             | 23,34              |
| TS1074   | Lightspeed       |                        | 345135     |                  | .992006                      | .993046         | .993026            | .993206                      | 202             | 23,34              |
| TS1075   | Lightspeed (LH)  |                        | 345165     |                  |                              | .993056         | .993036            | .993216                      | 202             | 23,34              |
| TS1116   | Silverado        | .031041                | 335130     |                  | .992113                      | .993143         |                    |                              | See Note 3      | 22                 |
| TS1118   | Silverado        | .031042                | 335131     |                  | .992114                      | .993144         |                    |                              | See Note 3      | 22                 |
| TS1120   | Lightspeed       | .031043                | 335132     |                  | .992115                      | .993145         |                    |                              | See Note 3      | 22                 |
| TS1122   | Lightspeed       | .031044                | 335133     |                  | .992116                      | .993146         |                    |                              | See Note 3      | 22                 |
| TS1164T  | Silverado        | .031016                |            |                  | .992305                      | .993405         |                    |                              | 114             | 21                 |
| TS1166T  | Silverado        | .031017                | 395129     |                  | .992406                      | .993406         |                    |                              | 114             | 21                 |
| TS1168T  | Silverado        | .031058                |            |                  | .992407                      | .993407         |                    |                              | 114             | 21                 |
| <b>NISSAN®, TOHATSU®</b>                             |                  |                        |            |                  |                              |                 |                    |                              |                 |                    |
| 348641020  |                  |                        |            |                  | .992605                      | .993406         |                    |                              | 116             | 25                 |
| 348641030  |                  |                        |            |                  | .992606                      | .993407         |                    |                              | 116             | 25                 |
| 348641080  |                  |                        |            |                  | .992401                      |                 |                    |                              | 112             | 26                 |
| 353641010  |                  |                        |            |                  | .992401                      |                 |                    |                              | 112             | 26                 |
| 353641010  |                  |                        |            |                  | .992401                      |                 |                    |                              | 112             | 26                 |

# MICHIGAN WHEEL OEM CROSS REFERENCE

| Original Equipment Manufacturer<br>Part & Trade Mark | Standard Hub Propeller |            |                  | XHS® / XHS II® Hub Propeller |                 |                    | XHS® / XHS II®<br>Hub Kit(s) | Catalog Page #s |
|--|------------------------|------------|------------------|------------------------------|-----------------|--------------------|------------------------------|-----------------|
|  | Michigan<br>Match®     | Ballistic® | Ballistic®<br>XL | Vortex®<br>XHS               | Apollo®<br>Std. | Apollo®<br>Lg. Dia |                              |                 |
| <b>NISSAN®, TOHATSU® (Continued)</b>                 |                        |            |                  |                              |                 |                    |                              |                 |
| 353641020  |                        |            |                  | 992402                       |                 |                    | 112                          | 26              |
| 353641030  |                        |            |                  | 992403                       |                 |                    | 112                          | 26              |
| 353641050  |                        |            |                  | 992301                       |                 |                    | 112                          | 26              |
| 353641070  |                        |            |                  | 992302                       |                 |                    | 112                          | 26              |
| 353641090  |                        |            |                  | 992303                       |                 |                    | 112                          | 26              |
| 361641130  |                        |            |                  | 992603                       |                 |                    | 116                          | 25              |
| 361641140  |                        |            |                  | 992604                       |                 |                    | 116                          | 25              |
| 362641020  | 142017                 |            |                  |                              |                 |                    |                              | 25              |
| 345-64101-5  |                        |            |                  | 992501                       |                 |                    | 122                          | 25              |
| 34664-1015M  |                        |            |                  | 992501                       |                 |                    | 122                          | 25              |
| 34664-1025M  |                        |            |                  | 992502                       |                 |                    | 122                          | 25              |
| 346-64103-5  |                        |            |                  | 992503                       |                 |                    | 122                          | 25              |
| 346-64105-5  |                        |            |                  | 992506                       |                 |                    | 122                          | 25              |
| 34664-1055M  |                        |            |                  | 992506                       |                 |                    | 122                          | 25              |
| 346-64106-5  | 142020                 |            |                  |                              |                 |                    |                              | 25              |
| 346B641065   | 142020                 |            |                  |                              |                 |                    |                              | 25              |
| 346W641055   |                        |            |                  | 992506                       |                 |                    | 122                          | 25              |
| 346W641065   | 142020                 |            |                  |                              |                 |                    |                              | 25              |
| 348-64102-0  |                        |            |                  | 992605                       | 993406          |                    | 116                          | 25              |
| 348-64103-0  |                        |            |                  | 992606                       | 993407          |                    | 116                          | 25              |
| 348-64104-0  |                        |            |                  | 992604                       | 993405          |                    | 116                          | 25              |
| 348W641080   |                        |            |                  | 992401                       |                 |                    | 116                          | 25              |
| 353-64105-0  |                        |            |                  | 992301                       |                 |                    | 112                          | 26              |
| 35364-1050M  |                        |            |                  | 992301                       |                 |                    | 112                          | 26              |
| 353-64107-0  | 142007*                |            |                  | 992302                       |                 |                    | 112                          | 26              |
| 35364-1070M  |                        |            |                  | 992302                       |                 |                    | 112                          | 26              |
| 353-64108-0  | 142008*                |            |                  |                              |                 |                    |                              | 26              |
| 353-64109-0  | 142009*                |            |                  | 992303                       |                 |                    | 112                          | 26              |
| 35364-1090M  | 142009*                |            |                  | 992303                       |                 |                    | 112                          | 26              |
| 361-64102-0  |                        |            |                  | 992605                       |                 |                    | 116                          | 25              |
| 361-64103-0  |                        |            |                  | 992606                       |                 |                    | 116                          | 25              |
| 361-64113-0  | 142001                 |            |                  | 992603                       |                 |                    | 116                          | 25              |
| 631-64114-0  | 142002                 |            |                  | 992604                       |                 |                    | 116                          | 25              |
| 362-64102-0  | 142017                 |            |                  |                              |                 |                    |                              | 25              |
| 362W641020   | 142017                 |            |                  |                              |                 |                    |                              | 25              |
| 3B7-64527-0  |                        |            |                  | 992112                       |                 |                    | See Note 4                   | 26              |
| 3B7-64532-0  |                        | 335930     |                  | 992113                       | 993143          |                    | See Note 4                   | 26              |
| 3B7-64536-0  |                        | 335930     |                  | 992113                       | 993143          |                    | See Note 4                   | 26              |
| 3B7-64541-0  |                        | 335931     |                  | 992114                       | 993144          |                    | See Note 4                   | 26              |
| 3B7-64545-0  | 142013*                | 335932     |                  | 992115                       | 993145          |                    | See Note 4                   | 26              |
| 3B7-64549-0  |                        | 335933     |                  |                              |                 |                    |                              | 26              |
| 3C7-64514-0  |                        | 335931     |                  | 992114                       | 993144          |                    | See Note 4                   | 26              |
| 3C7-64536-0  |                        | 335931     |                  | 992114                       | 993144          |                    | See Note 4                   | 26              |
| 3C7-645360M  |                        | 335930     |                  | 992113                       | 993143          |                    | See Note 4                   | 26              |
| 3C7-764510M  |                        | 335931     |                  | 992114                       | 993144          |                    | See Note 4                   | 26              |
| 3C7-645490M  |                        | 335932     |                  | 992115                       | 993145          |                    | See Note 4                   | 26              |
| 3C7-645540M  |                        | 335933     |                  | 992116                       | 993146          |                    | See Note 4                   | 26              |
| 3E0641810M   |                        |            |                  | 992112                       |                 |                    | See Note 4                   | 26              |
| 3E0641850M   |                        | 335930     |                  | 992113                       | 993143          |                    | See Note 4                   | 26              |
| 3E0641890M   |                        | 335931     |                  | 992114                       | 993144          |                    | See Note 4                   | 26              |
| 3E0641940M   |                        | 335932     |                  | 992115                       | 993145          |                    | See Note 4                   | 26              |
| 3E0641960M   |                        | 335933     |                  | 992116                       | 993146          |                    | See Note 4                   | 26              |
| 3E3645260M   |                        |            |                  | 992604                       | 993405          |                    | See Note 4                   | 25              |
| 3E3645280M   |                        |            |                  | 992605                       | 993406          |                    | See Note 4                   | 25              |
| 3E3645310M   |                        |            |                  | 992606                       | 993407          |                    | See Note 4                   | 25              |
| 3E3645360M   |                        |            |                  | 992408                       | 993408          |                    | See Note 4                   | 25              |
| 3N4W645271   |                        |            |                  | 992112                       |                 |                    | See Note 4                   | 26              |
| 3N4W645321   |                        | 335930     |                  | 992113                       | 993143          |                    | See Note 4                   | 26              |
| 3N4W645361   |                        | 335931     |                  | 992114                       | 993144          |                    | See Note 4                   | 26              |
| 3N4W645411   |                        | 335932     |                  | 992115                       | 993145          |                    | See Note 4                   | 26              |
| 3N4W645451   |                        | 335933     |                  | 992116                       | 993146          |                    | See Note 4                   | 26              |
| 3R064-5250M  |                        |            |                  | 992504                       |                 |                    | 122                          | 25              |
| 3R0W645210   |                        |            |                  | 992502                       |                 |                    | 122                          | 25              |
| 3R0W645230   |                        |            |                  | 992503                       |                 |                    | 122                          | 25              |
| 3R0W645250   |                        |            |                  | 992504                       |                 |                    | 122                          | 25              |
| 3R0W645270   |                        | 305429     |                  | 992505                       |                 |                    | 122                          | 25              |

\* Indicates limited quantities.

# MICHIGAN WHEEL OEM CROSS REFERENCE

| Original Equipment Manufacturer<br>Part & Trade Mark | Standard Hub Propeller |            |                  | XHS® / XHS II® Hub Propeller |                 |                    | XHS® / XHS II®<br>Hub Kit(s) | Catalog Page #s |
|--|------------------------|------------|------------------|------------------------------|-----------------|--------------------|------------------------------|-----------------|
|  | Michigan<br>Match®     | Ballistic® | Ballistic®<br>XL | Vortex®<br>XHS               | Apollo®<br>Std. | Apollo®<br>Lg. Dia |                              |                 |

## NISSAN®, TOHATSU® (Continued)

|              |               |        |  |        |        |  |     |    |
|--------------|---------------|--------|--|--------|--------|--|-----|----|
| 3R0W645480   |               |        |  | 992501 |        |  | 122 | 25 |
| 3T5B645320   |               |        |  | 992603 |        |  | 116 | 25 |
| 3T5645230    |               |        |  | 992603 |        |  | 116 | 25 |
| 3T5645250    |               |        |  | 992604 | 993405 |  | 116 | 25 |
| 3T5645270    |               |        |  | 992605 | 993406 |  | 116 | 25 |
| 3T5645290    |               |        |  | 992606 | 993407 |  | 116 | 25 |
| 3T5645320    |               |        |  | 992408 | 993408 |  | 116 | 25 |
| 9999RUBA313M | Solas® Rubex® |        |  | 992112 |        |  | 209 | 26 |
| 9999RUBA315M | Solas® Rubex® |        |  | 992113 | 993143 |  | 209 | 26 |
| 9999RUBA317M | Solas® Rubex® |        |  | 992114 | 993144 |  | 209 | 26 |
| 9999RUBA319M | Solas® Rubex® |        |  | 992115 | 993145 |  | 209 | 26 |
| 9999RUBA321M | Solas® Rubex® |        |  | 992116 | 993146 |  | 209 | 26 |
| NM889210130  |               | 305429 |  |        |        |  |     | 25 |
| NM889410120  |               |        |  | 992604 | 993405 |  | 116 | 25 |
| NM889410130  |               |        |  | 992605 | 993406 |  | 116 | 25 |
| NM889410140  |               |        |  | 992606 | 993407 |  | 116 | 25 |
| NM889410150  |               |        |  | 992408 | 993408 |  | 116 | 25 |
| NM889510150  |               | 325030 |  |        |        |  |     | 26 |
| NM889510170  |               | 325031 |  |        |        |  |     | 26 |
| NM889610150  |               | 335930 |  | 992113 | 993143 |  | 209 | 26 |
| NM889610170  |               | 335931 |  | 992114 | 993144 |  | 209 | 26 |
| NM889610180  |               | 335932 |  | 992115 | 993145 |  | 209 | 26 |
| NM889610200  |               | 335933 |  | 992116 | 993146 |  | 209 | 26 |

## SUZUKI®

|                 |                   |        |        |        |        |  |            |    |
|-----------------|-------------------|--------|--------|--------|--------|--|------------|----|
| 58100-90420-019 | DF 90 / 115 / 140 | 061032 |        | 992116 | 993146 |  | See Note 4 | 29 |
| 58100-90J00-019 | DF 90 / 115 / 140 | 061024 |        | 992114 | 993144 |  | See Note 4 | 29 |
| 58100-90J01-019 | DF 90 / 115 / 140 | 061024 |        | 992114 | 993144 |  | See Note 4 | 29 |
| 58100-90J10-019 | DF 90 / 115 / 140 | 061028 |        | 992115 | 993145 |  | See Note 4 | 29 |
| 58100-90J11-019 | DF 90 / 115 / 140 | 061028 |        | 992115 | 993145 |  | See Note 4 | 29 |
| 58100-90J20-019 | DF 90 / 115 / 140 | 061032 |        | 992116 | 993146 |  | See Note 4 | 29 |
| 58100-90J21-019 | DF 90 / 115 / 140 | 061032 |        | 992116 | 993146 |  | See Note 4 | 29 |
| 58100-90J41-019 | DF 90 / 115 / 140 | 061020 |        | 992113 | 993143 |  | See Note 4 | 29 |
| 58100-93723-019 |                   | 062016 |        |        |        |  |            | 27 |
| 58100-93733-019 |                   | 062016 |        |        |        |  |            | 27 |
| 58100-93763-019 |                   | 062016 |        |        |        |  |            | 27 |
| 58100-94313-019 |                   | 032042 | 395929 | 992605 | 993406 |  | 115        | 28 |
| 58100-94410     |                   |        |        | 992606 | 993407 |  | 115        | 28 |
| 58100-94411     |                   |        |        | 992606 | 993407 |  | 115        | 28 |
| 58100-94412     |                   |        |        | 992606 | 993407 |  | 115        | 28 |
| 58100-94500-019 |                   |        |        | 992113 | 993143 |  | 210        | 28 |
| 58100-94512-019 |                   |        |        | 992114 | 993144 |  | 210        | 28 |
| 58100-94522-019 |                   |        |        | 992115 | 993145 |  | 210        | 28 |
| 58100-94532-019 |                   |        |        | 992116 | 993146 |  | 210        | 28 |
| 58100-94554     |                   |        |        | 992113 | 993143 |  | 210        | 28 |
| 58100-94561     |                   |        |        | 992115 | 993145 |  | 210        | 28 |
| 58100-94571     |                   |        |        | 992116 | 993146 |  | 210        | 28 |
| 58100-94581     |                   |        |        | 992114 | 993144 |  | 210        | 28 |
| 58100-95212-019 |                   | 032045 |        | 992602 |        |  | 115        | 28 |
| 58100-95222-019 |                   | 032044 |        | 992603 |        |  | 115        | 28 |
| 58100-95353-019 |                   | 032041 |        | 992606 | 993406 |  | 115        | 28 |
| 58100-95363-019 |                   | 032040 | 395929 | 992408 | 993407 |  | 115        | 28 |
| 58100-95373-019 |                   |        |        | 992409 | 993408 |  | 115        | 28 |
| 58100-95382-019 |                   |        | 395930 |        |        |  |            | 28 |
| 58100-95393-019 |                   | 032043 |        | 992604 | 993405 |  | 115        | 28 |
| 58100-95500-019 |                   |        |        | 992113 | 993143 |  | 210        | 28 |
| 58100-95511-019 |                   |        |        | 992114 | 993144 |  | 210        | 28 |
| 58100-95521-019 |                   |        |        | 992115 | 993145 |  | 210        | 28 |
| 58100-95530-019 |                   |        |        | 992116 | 993146 |  | 210        | 28 |
| 58100-95D00-019 |                   |        | 305529 | 992505 |        |  | 121        | 27 |
| 58100-96370-019 |                   |        |        | 992501 |        |  | 121        | 27 |
| 58100-96410-019 |                   |        |        | 992502 |        |  | 121        | 27 |
| 58100-96420-019 |                   |        |        | 992503 |        |  | 121        | 27 |
| 58100-96430-019 |                   |        |        | 992404 |        |  | 121        | 27 |
| 58100-96440-019 |                   |        | 305529 | 992505 |        |  | 121        | 27 |
| 58100-96460-019 |                   |        |        | 992506 |        |  | 121        | 27 |

# MICHIGAN WHEEL OEM CROSS REFERENCE

| Original Equipment Manufacturer<br>Part & Trade Mark | Standard Hub Propeller |            |                  | XHS® / XHS II® Hub Propeller |                 |                    | XHS® / XHS II®<br>Hub Kit(s) | Catalog Page #s |
|--|------------------------|------------|------------------|------------------------------|-----------------|--------------------|------------------------------|-----------------|
|  | Michigan<br>Match®     | Ballistic® | Ballistic®<br>XL | Vortex®<br>XHS               | Apollo®<br>Std. | Apollo®<br>Lg. Dia |                              |                 |

## SUZUKI® (Continued)

|                 |  |        |  |        |        |        |        |            |    |
|-----------------|--|--------|--|--------|--------|--------|--------|------------|----|
| 58100-96470-019 |  |        |  | 992502 |        |        |        | 121        | 27 |
| 58100-96480-019 |  |        |  | 992504 |        |        |        | 121        | 27 |
| 58100-96490-019 |  | 305529 |  | 992505 |        |        |        | 121        | 27 |
| 58100-99E00-019 |  |        |  | 992112 |        |        |        | 210        | 28 |
| 58200-96400     |  | 305529 |  |        |        |        |        |            | 27 |
| 990C0-00830-17P |  |        |  | 992003 | 993043 | 993023 | 993203 | 204        | 29 |
| 990C0-00830-19P |  |        |  | 992004 | 993044 | 993024 | 993204 | 204        | 29 |
| 990C0-00830-21P |  |        |  | 992005 | 993045 | 993025 | 993205 | 204        | 29 |
| 990C0-00830-23P |  |        |  | 992006 | 993046 | 993026 | 993206 | 204        | 29 |
| 990C0-0083L-17P |  |        |  |        |        | 993033 | 993213 | 204        | 29 |
| 990C0-0083L-19P |  |        |  |        |        | 993034 | 993214 | 204        | 29 |
| 990C0-0083L-21P |  |        |  |        |        | 993035 | 993215 | 204        | 29 |
| 990C0-0083L-23P |  |        |  |        |        | 993036 | 993216 | 204        | 29 |
| 99105-00100-16P |  |        |  | 992113 | 993143 |        |        | 210        | 28 |
| 99105-00100-18P |  |        |  | 992114 | 993144 |        |        | 210        | 28 |
| 99105-00100-20P |  |        |  | 992115 | 993145 |        |        | 210        | 28 |
| 99105-00100-22P |  |        |  | 992116 | 993146 |        |        | 210        | 28 |
| 99105-00101-20P |  |        |  | 992115 | 993145 |        |        | 210        | 28 |
| 99105-00101-22P |  |        |  | 992116 | 993146 |        |        | 210        | 28 |
| 99105-00103-18P |  |        |  | 992114 | 993144 |        |        | 210        | 28 |
| 99105-00103-20P |  |        |  | 992115 | 993145 |        |        | 210        | 28 |
| 99105-00103-22P |  |        |  | 992116 | 993146 |        |        | 210        | 28 |
| 99105-00200-16P |  |        |  | 992002 | 993042 | 993022 |        | 204        | 29 |
| 99105-00200-18P |  |        |  | 992003 | 993043 | 993023 | 993203 | 204        | 29 |
| 99105-00200-20P |  |        |  | 992004 | 993044 | 993024 | 993204 | 204        | 29 |
| 99105-00200-22P |  |        |  | 992005 | 993045 | 993025 | 993205 | 204        | 29 |
| 99105-00200-24P |  |        |  | 992006 | 993046 | 993026 | 993206 | 204        | 29 |
| 99105-00203-23P |  |        |  | 992006 | 993046 | 993026 | 993206 | 204        | 29 |
| 99105-0020L-16P |  |        |  |        | 993052 | 993032 |        | 204        | 29 |
| 99105-0020L-18P |  |        |  |        | 993053 | 993033 | 993213 | 204        | 29 |
| 99105-0020L-20P |  |        |  |        | 993054 | 993034 | 993214 | 204        | 29 |
| 99105-0020L-22P |  |        |  |        | 993055 | 993035 | 993215 | 204        | 29 |
| 99105-0020L-24P |  |        |  |        | 993056 | 993036 | 993216 | 204        | 29 |
| 99105-00300-24P |  |        |  | 992006 | 993046 | 993026 | 993206 | 204        | 29 |
| 99105-00400-23P |  |        |  | 992006 | 993046 | 993026 | 993206 | 204        | 29 |
| 99105-00500-12P |  |        |  | 992604 | 993405 |        |        | 115        | 28 |
| 99105-00500-13P |  | 395929 |  | 992605 | 993406 |        |        | 115        | 28 |
| 99105-00500-14P |  |        |  | 992606 | 993407 |        |        | 115        | 28 |
| 99105-00500-15P |  | 395930 |  | 992408 | 993408 |        |        | 115        | 28 |
| 99105-00600-13P |  | 305529 |  |        |        |        |        |            | 27 |
| 99105-00600-15P |  | 305530 |  |        |        |        |        |            | 27 |
| 99105-00700-16P |  |        |  | 992114 | 993144 |        |        | See Note 4 | 29 |
| 99105-00700-18P |  |        |  | 992115 | 993145 |        |        | See Note 4 | 29 |
| 99105-00700-20P |  |        |  | 992116 | 993146 |        |        | See Note 4 | 29 |
| 99105-0070L-18P |  |        |  |        | 993155 |        |        | See Note 4 | 29 |
| 99105-0070L-20P |  |        |  |        | 993156 |        |        | See Note 4 | 29 |

## VOLVO®

|         |                          |        |        |        |        |        |        |     |    |
|---------|--------------------------|--------|--------|--------|--------|--------|--------|-----|----|
| 3587517 | SS 4-Blade Polished      | 161001 | 346031 | 992002 | 993042 |        |        | 205 | 38 |
| 3587519 | SS 4-Blade Polished (LH) |        |        |        | 993052 |        |        | 205 | 38 |
| 3587520 | SS 4-Blade Polished      | 161002 | 346032 | 992003 | 993043 | 993023 | 993203 | 205 | 38 |
| 3587521 | SS 4-Blade Polished (LH) |        | 346062 |        | 993053 | 993033 | 993213 | 205 | 38 |
| 3587522 | SS 4-Blade Polished      | 161003 | 346033 | 992004 | 993044 | 993024 | 993204 | 205 | 38 |
| 3587523 | SS 4-Blade Polished (LH) |        | 346063 |        | 993054 | 993034 | 993214 | 205 | 38 |
| 3587524 | SS 4-Blade Polished      | 161004 | 346034 | 992005 | 993045 | 993025 | 993205 | 205 | 38 |
| 3587525 | SS 4-Blade Polished (LH) |        | 346064 |        | 993055 | 993035 | 993215 | 205 | 38 |
| 3587526 | SS 4-Blade Polished      | 161005 | 346035 | 992006 | 993046 | 993026 | 993206 | 205 | 38 |
| 3850299 |                          | 161001 |        | 992002 | 993042 |        |        | 205 | 38 |
| 3850300 |                          | 161002 | 346032 | 992003 | 993043 | 993023 | 993203 | 205 | 38 |
| 3850301 |                          | 161003 | 346033 | 992004 | 993044 | 993024 | 993204 | 205 | 38 |
| 3850302 |                          | 161004 | 346034 | 992005 | 993045 | 993025 | 993205 | 205 | 38 |
| 3850303 |                          | 161005 | 346035 | 992006 | 993046 | 993026 | 993206 | 205 | 38 |
| 3850305 | SST®                     | 161001 | 346031 | 992002 | 993042 |        |        | 205 | 38 |
| 3850306 | SST®                     | 161002 | 346032 | 992003 | 993043 | 993023 | 993203 | 205 | 38 |
| 3850307 | SST®                     | 161002 | 346032 | 992003 | 993043 | 993023 | 993203 | 205 | 38 |
| 3850308 | SST®                     | 161003 | 346033 | 992004 | 993044 | 993024 | 993204 | 205 | 38 |

# MICHIGAN WHEEL OEM CROSS REFERENCE

| Original Equipment Manufacturer<br>Part & Trade Mark | Standard Hub Propeller   |            |                  | XHS® / XHS II® Hub Propeller |                 |                    | XHS® / XHS II®<br>Hub Kit(s) | Catalog Page #s |
|--|--------------------------|------------|------------------|------------------------------|-----------------|--------------------|------------------------------|-----------------|
|  | Michigan<br>Match®       | Ballistic® | Ballistic®<br>XL | Vortex®<br>XHS               | Apollo®<br>Std. | Apollo®<br>Lg. Dia |                              |                 |
| <b>VOLVO® (Continued)</b>                            |                          |            |                  |                              |                 |                    |                              |                 |
| 3850309.....   | SST®                     | 161004     | 346034           | 992005                       | 993045          | 993025             | 993205                       | 205.....38      |
| 3850310.....   | SST®                     | 161005     | 346035           | 992006                       | 993046          | 993026             | 993206                       | 205.....38      |
| 3850311.....   | VIPER™                   | 161002     | 346032           | 992003                       | 993043          | 993023             | 993203                       | 205.....38      |
| 3850312.....   | VIPER™                   | 161003     | 346033           | 992004                       | 993044          | 993024             | 993204                       | 205.....38      |
| 3850313.....   | VIPER™                   | 161004     | 346034           | 992005                       | 993045          | 993025             | 993205                       | 205.....38      |
| 3850314.....   | VIPER™                   | 161005     | 346035           | 992006                       | 993046          | 993026             | 993206                       | 205.....38      |
| 3850315.....   | SST® (LH)                |            |                  |                              | 993052          | 993032             |                              | 205.....38      |
| 3850316.....   | SST® (LH)                |            | 346062           |                              | 993053          | 993033             | 993213                       | 205.....38      |
| 3850317.....   | SST® (LH)                |            | 346063           |                              | 993054          | 993034             | 993214                       | 205.....38      |
| 3850318.....   | SST® (LH)                |            | 346064           |                              | 993055          | 993035             | 993215                       | 205.....38      |
| 3850319.....   | SST® (LH)                |            | 346065           |                              | 993056          | 993036             | 993216                       | 205.....38      |
| 3850320.....   | VIPER™ (LH)              |            | 346062           |                              | 993053          | 993033             | 993213                       | 205.....38      |
| 3850321.....   | VIPER™ (LH)              |            | 346063           |                              | 993054          | 993034             | 993214                       | 205.....38      |
| 3850322.....   | VIPER™ (LH)              |            | 346064           |                              | 993055          | 993035             | 993215                       | 205.....38      |
| 3850323.....   | VIPER™ (LH)              |            | 346065           |                              | 993056          | 993036             | 993216                       | 205.....38      |
| 2855142.....   | Raker®                   | 161003     | 346034           | 992004                       | 993044          | 993024             | 993204                       | 205.....38      |
| 3855144.....   | Raker®                   | 161004     | 346035           | 992005                       | 993045          | 993025             | 993205                       | 205.....38      |
| 3855146.....   | Raker®                   | 161005     | 346036           | 992006                       | 993046          | 993026             | 993206                       | 205.....38      |
| 3855152.....   | Raker® (LH)              |            | 346064           |                              | 993054          | 993034             | 993214                       | 205.....38      |
| 3855154.....   | Raker® (LH)              |            | 345065           |                              | 993055          | 993035             | 993215                       | 205.....38      |
| 3855156.....   | Raker® (LH)              |            |                  |                              | 993056          | 993036             | 993216                       | 205.....38      |
| 3855481.....   |                          |            | 346063           |                              | 993054          |                    |                              | 205.....38      |
| 3860708.....   | SS 3-Blade Polished      | 161003     | 346033           | 992004                       | 993044          | 993024             | 993204                       | 205.....38      |
| 3860709.....   | SS 3-Blade Polished      | 161004     | 346034           | 992005                       | 993045          | 993025             | 993205                       | 205.....38      |
| 3860714.....   | SS 3-Blade Polished (LH) |            | 346062           |                              | 993053          | 993033             | 993213                       | 205.....38      |
| 3860715.....   | SS 3-Blade Polished (LH) |            | 346063           |                              | 993054          | 993034             | 993214                       | 205.....38      |
| 3860716.....   | SS 3-Blade Polished (LH) |            | 346064           |                              | 993055          | 993035             | 993215                       | 205.....38      |
| 3860717.....   | SS 3-Blade Polished (LH) |            | 346065           |                              | 993056          | 993036             | 993216                       | 205.....38      |
| 3862462.....   | SS 3-Blade Polished      | 161002     | 346032           | 992003                       | 993043          | 993023             | 993203                       | 205.....38      |
| 3870710.....   | SS 3-Blade Polished      | 161005     | 346035           | 992006                       | 993046          | 993026             | 993206                       | 205.....38      |
| 3850298-5.....                                       |                          | 161002     | 346032           | 992003                       | 993043          | 993023             | 993203                       | 205.....38      |
| 3850299-3.....                                       |                          | 161001     | 346031           | 992002                       | 993042          |                    |                              | 205.....38      |
| 3850300-9.....                                       |                          | 161002     | 346032           | 992003                       | 993043          | 993023             | 993203                       | 205.....38      |
| 3850301-7.....                                       |                          | 161003     | 346033           | 992004                       | 993044          | 993024             | 993204                       | 205.....38      |
| 3850302-5.....                                       |                          | 161004     | 346034           | 992005                       | 993045          | 993025             | 993205                       | 205.....38      |
| 3850303-3.....                                       |                          | 161005     | 346035           | 992006                       | 993046          | 993026             | 993206                       | 205.....38      |
| 3850305-8.....                                       | SS Black                 | 161001     | 346031           |                              | 993042          |                    |                              | 205.....38      |
| 3850307-4.....                                       | SS Black                 | 161002     | 346032           |                              | 993043          | 993023             | 993203                       | 205.....38      |
| 3850308-2.....                                       | SS Black                 | 161003     | 346033           |                              | 993044          | 993024             | 993204                       | 205.....38      |
| 3850309-0.....                                       | SS Black                 | 161004     | 346034           |                              | 993045          | 993025             | 993205                       | 205.....38      |
| 3850310-8.....                                       | SS Black                 | 161005     | 346035           |                              | 993046          | 993026             | 993206                       | 205.....38      |
| 3850311-6.....                                       | SS 3-Blade Polished      | 161002     | 346032           |                              | 993043          | 993023             | 993203                       | 205.....38      |
| 3850312-4.....                                       | SS 3-Blade Polished      | 161003     | 346033           |                              | 993044          | 993024             | 993204                       | 205.....38      |
| 3850313-2.....                                       | SS 3-Blade Polished      | 161005     | 346035           |                              | 993046          | 993026             | 993206                       | 205.....38      |
| 3850314-0.....                                       | SS 3-Blade Polished      | 161004     | 346034           |                              | 993045          | 993025             | 993205                       | 205.....38      |
| 3850315-7.....                                       | SS Black (LH)            |            |                  |                              | 993052          | 993032             |                              | 205.....38      |
| 3850316-5.....                                       | SS Black (LH)            |            | 346062           |                              | 993053          | 993033             | 993213                       | 205.....38      |
| 3850317-3.....                                       | SS Black (LH)            |            | 346063           |                              | 993054          | 993034             | 993214                       | 205.....38      |
| 3850318-1.....                                       | SS Black (LH)            |            | 346064           |                              | 993055          | 993035             | 993215                       | 205.....38      |
| 3850319-9.....                                       | SS Black (LH)            |            | 346065           |                              | 993056          | 993036             | 993216                       | 205.....38      |
| 3850320-7.....                                       | SS 3-Blade Polished (LH) |            | 346062           |                              | 993053          |                    |                              | 205.....38      |
| 3850321-5.....                                       | SS 3-Blade Polished (LH) |            | 346063           |                              | 993054          | 993034             | 993214                       | 205.....38      |
| 3850322-3.....                                       | SS 3-Blade Polished (LH) |            | 346065           |                              | 993056          | 993036             | 993216                       | 205.....38      |
| 3850323-1.....                                       | SS 3-Blade Polished (LH) |            | 346064           |                              | 993055          | 993035             | 993215                       | 205.....38      |
| 3855480-4.....                                       |                          |            |                  |                              |                 | 993033             |                              | 205.....38      |
| 3855481-2.....                                       |                          |            |                  |                              |                 | 993034             |                              | 205.....38      |
| 3858026-2.....                                       | SS 3-Blade Polished      | 161002     | 346032           | 992003                       | 993043          | 993023             | 993203                       | 205.....38      |
| 3858027-0.....                                       | SS 3-Blade Polished      | 161003     | 346033           | 992004                       | 993044          | 993024             | 993204                       | 205.....38      |
| 3858028-8.....                                       | SS 3-Blade Polished      | 161004     | 346034           | 992005                       | 993045          | 993025             | 993205                       | 205.....38      |
| 3858029-6.....                                       | SS 3-Blade Polished (LH) |            | 346062           |                              | 993053          | 993033             | 993213                       | 205.....38      |
| 3858030-4.....                                       | SS 3-Blade Polished (LH) |            | 346063           |                              | 993054          | 993034             | 993214                       | 205.....38      |
| 3858031-2.....                                       | SS 3-Blade Polished (LH) |            | 346064           |                              | 993055          | 993035             | 993215                       | 205.....38      |
| <b>YAMAHA®</b>                                       |                          |            |                  |                              |                 |                    |                              |                 |
| 61A-45972-00-98.....                                 | Black Steel              |            | 345934           |                              | 993045          | 993025             | 993205                       | 203.....33,39   |
| 61A-45974-00-98.....                                 | Black Steel              |            | 345933           |                              | 993044          | 993024             | 993204                       | 203.....33,39   |

# MICHIGAN WHEEL OEM CROSS REFERENCE

| Original Equipment Manufacturer<br>Part & Trade Mark | Standard Hub Propeller  |            |                  | XHS® / XHS II® Hub Propeller |                 |                    | XHS® / XHS II®<br>Hub Kit(s) | Catalog Page #s |                    |
|--|-------------------------|------------|------------------|------------------------------|-----------------|--------------------|------------------------------|-----------------|--------------------|
|  | Michigan<br>Match®      | Ballistic® | Ballistic®<br>XL | Vortex®<br>XHS               | Apollo®<br>Std. | Apollo®<br>Lg. Dia |                              |                 | Apollo®<br>4-Blade |
| <b>YAMAHA® (Continued)</b>                           |                         |            |                  |                              |                 |                    |                              |                 |                    |
| 61A-45978-00-98.....                                 | Black Steel             |            | 345932           |                              | 993043          | 993023             | 993203                       | 203.....        | 33,39              |
| 61B-45972-00-98.....                                 | Black Steel (LH)        |            | 345964           |                              | 993055          | 993035             | 993215                       | 203.....        | 33,39              |
| 61B-45974-00-98.....                                 | Black Steel (LH)        |            | 345963           |                              | 993054          | 993034             | 993214                       | 203.....        | 33,39              |
| 61B-45978-00-98.....                                 | Black Steel (LH)        |            | 345962           |                              | 993053          | 993033             | 993213                       | 203.....        | 33,39              |
| 62A-45970-10-00.....                                 | Pro Series™             |            | 335934           |                              | 993145          |                    |                              | See Note 1      | 32                 |
| 62A-45970-10-00 PRO.....                             | Pro Series™ HP          |            |                  |                              | 993146          |                    |                              | See Note 1      | 32                 |
| 62A-45972-10-00.....                                 | Pro Series™             |            | 335935           |                              | 993146          |                    |                              | See Note 1      | 32                 |
| 62A-45974-10-00 PRO.....                             | Pro Series™ HP          |            | 335932           |                              | 993145          |                    |                              | See Note 1      | 32                 |
| 63V-45947-00-EL.....                                 |                         |            | 102003           |                              |                 |                    |                              |                 | 30                 |
| 63V-45945-10-EL.....                                 |                         |            | 102004           |                              |                 |                    |                              |                 | 30                 |
| 650-45943-01-36.....                                 |                         |            | 012102           |                              |                 |                    |                              |                 | 30                 |
| 651-45947-00-36.....                                 |                         |            | 012011           |                              |                 |                    |                              |                 | 30                 |
| 653-45941-01-36.....                                 |                         |            | 012013           |                              |                 |                    |                              |                 | 30                 |
| 663-45930-00-98.....                                 | Painted Stainless Steel |            |                  |                              | 993407          |                    |                              | 117.....        | 31                 |
| 663-45943-01-36.....                                 |                         |            | 032040           |                              | 992408          | 993408             |                              | 117.....        | 31                 |
| 663-45943-02-36.....                                 |                         |            | 032040           |                              | 992408          | 993408             |                              | 117.....        | 31                 |
| 663-45943-02-EL.....                                 |                         |            | 032040           |                              | 992408          | 993408             |                              | 117.....        | 31                 |
| 663-45945-00-EL.....                                 |                         |            | 032042           |                              | 992605          | 993406             |                              | 117.....        | 31                 |
| 663-45945-01-36.....                                 |                         |            | 032042           |                              | 992605          | 992406             |                              | 117.....        | 31                 |
| 663-45945-02-36.....                                 |                         |            | 032042           |                              | 992605          | 993406             |                              | 117.....        | 31                 |
| 663-45945-02-EL.....                                 |                         |            | 032042           |                              | 992605          | 993406             |                              | 117.....        | 31                 |
| 663-45947-01-36.....                                 |                         |            | 032044           |                              | 992603          |                    |                              | 117.....        | 31                 |
| 663-45947-02-36.....                                 |                         |            | 032044           |                              | 992603          |                    |                              | 117.....        | 31                 |
| 663-45947-02-EL.....                                 |                         |            | 032044           |                              | 992603          |                    |                              | 117.....        | 31                 |
| 663-45949-01-36.....                                 |                         |            |                  |                              | 992409          |                    |                              | 117.....        | 31                 |
| 663-45952-01-EL.....                                 |                         |            |                  |                              | 992409          |                    |                              | 117.....        | 31                 |
| 663-45952-02-EL.....                                 |                         |            | 032043           |                              | 992604          | 993405             |                              | 117.....        | 31                 |
| 663-45956-01-EL.....                                 |                         |            | 032046           |                              | 992601          |                    |                              | 117.....        | 31                 |
| 663-45958-00-36.....                                 |                         |            | 032041           |                              | 992606          | 993407             |                              | 117.....        | 31                 |
| 663-45958-00-EL.....                                 |                         |            | 032041           |                              | 992606          | 993407             |                              | 117.....        | 31                 |
| 663-45958-01-36.....                                 |                         |            | 032041           |                              | 992606          | 993407             |                              | 117.....        | 31                 |
| 663-45958-01-EL.....                                 |                         |            | 032041           |                              | 992606          | 993407             |                              | 117.....        | 31                 |
| 663-45970-60-98.....                                 | Painted Stainless Steel |            | 032042           | 395929                       | 992605          | 993406             |                              | 117.....        | 31                 |
| 663-45972-60-98.....                                 | Painted Stainless Steel |            | 032043           |                              | 992604          | 993405             |                              | 117.....        | 31                 |
| 663-45974-60-98.....                                 | Painted Stainless Steel |            | 032042           | 395929                       | 992605          | 993406             |                              | 117.....        | 31                 |
| 663-45976-00-98.....                                 | Painted Stainless Steel |            | 032040           | 395930                       | 992408          | 993408             |                              | 117.....        | 31                 |
| 663-45978-00-98.....                                 |                         |            | 032040           | 395930                       | 992408          | 993408             |                              | 117.....        | 31                 |
| 664-45941-01-36.....                                 |                         |            | 022001           |                              | 992501          |                    |                              | 123.....        | 31                 |
| 664-45941-01-EL.....                                 |                         |            | 022001           |                              | 992501          |                    |                              | 123.....        | 31                 |
| 664-45945-00-36.....                                 |                         |            | 022002           |                              | 992502          |                    |                              | 123.....        | 31                 |
| 664-45945-00-EL.....                                 |                         |            | 022002           |                              | 992502          |                    |                              | 123.....        | 31                 |
| 664-45949-02-EL.....                                 |                         |            |                  | 305929                       | 992505          |                    |                              | 123.....        | 31                 |
| 664-45952-00-EL.....                                 |                         |            |                  | 305930                       | 992506          |                    |                              | 123.....        | 31                 |
| 664-45954-00-EL.....                                 |                         |            | 022003           |                              | 992504          |                    |                              | 123.....        | 31                 |
| 664-45954-01-EL.....                                 |                         |            | 022003           |                              | 992504          |                    |                              | 123.....        | 31                 |
| 664-45970-00-98.....                                 | Painted Stainless Steel |            |                  | 305929                       | 992505          |                    |                              | 123.....        | 31                 |
| 66K-45972-B0-00.....                                 | Pro Series™             |            |                  | 345938                       |                 |                    |                              |                 | 33,39              |
| 66K-45974-B0-00.....                                 | Pro Series™             |            |                  | 345937                       | 993046          |                    |                              | 203.....        | 33,39              |
| 683-45943-00-36.....                                 |                         |            | 102005           |                              |                 |                    |                              |                 | 30                 |
| 683-45943-00-EL.....                                 |                         |            | 102005           |                              |                 |                    |                              |                 | 30                 |
| 683-45945-00-36.....                                 |                         |            | 102004           |                              |                 |                    |                              |                 | 30                 |
| 683-45945-00-EL.....                                 |                         |            | 102004           |                              |                 |                    |                              |                 | 30                 |
| 683-45947-00-36.....                                 |                         |            | 102003           |                              |                 |                    |                              |                 | 30                 |
| 683-45947-00-EL.....                                 |                         |            | 102003           |                              |                 |                    |                              |                 | 30                 |
| 683-W4591-02-EL.....                                 |                         |            | 102003           |                              |                 |                    |                              |                 | 30                 |
| 688-45930-01-98.....                                 | Painted Stainless Steel |            | 101033           | 335931                       | 992114          | 993144             |                              | See Note 1      | 32                 |
| 688-45930-02-98.....                                 | Painted Stainless Steel |            | 101033           | 335931                       | 992114          | 993144             |                              | See Note 1      | 32                 |
| 688-45930-60-98.....                                 | Painted Stainless Steel |            | 101033           | 335931                       | 992114          | 993144             |                              | See Note 1      | 32                 |
| 688-45932-60-98.....                                 | Painted Stainless Steel |            |                  | 335930                       |                 |                    |                              |                 | 32                 |
| 688-45970-01-98.....                                 | Painted Stainless Steel |            | 101034           | 335932                       | 992115          | 993145             |                              | See Note 1      | 32                 |
| 688-45970-02-98.....                                 | Painted Stainless Steel |            | 101034           | 335932                       | 992115          | 993145             |                              | See Note 1      | 32                 |
| 688-45970-03-98.....                                 | Painted Stainless Steel |            | 101034           | 335932                       | 992115          | 993145             |                              | See Note 1      | 32                 |
| 688-45972-01-98.....                                 | Painted Stainless Steel |            | 101035           | 335933                       | 992116          | 993146             |                              | See Note 1      | 32                 |
| 688-45972-02-98.....                                 | Painted Stainless Steel |            | 101035           | 335933                       | 992116          | 993146             |                              | See Note 1      | 32                 |
| 688-45978-60-98.....                                 | Painted Stainless Steel |            | 101031           | 335931                       | 992113          | 993143             |                              | See Note 1      | 32                 |
| 68F-45970-00-00.....                                 | Reliance®               |            | 345931           |                              | 992002          | 993042             |                              | 203.....        | 33,39              |

# MICHIGAN WHEEL OEM CROSS REFERENCE

| Original Equipment Manufacturer<br>Part & Trade Mark |                           | Standard Hub Propeller |            |                  | XHS® / XHS II® Hub Propeller |                 |                    | XHS® / XHS II®<br>Hub Kit(s) | Catalog Page #s |                    |
|--|---------------------------|------------------------|------------|------------------|------------------------------|-----------------|--------------------|------------------------------|-----------------|--------------------|
|  |                           | Michigan<br>Match®     | Ballistic® | Ballistic®<br>XL | Vortex®<br>XHS               | Apollo®<br>Std. | Apollo®<br>Lg. Dia |                              |                 | Apollo®<br>4-Blade |
| <b>YAMAHA® (Continued)</b>                           |                           |                        |            |                  |                              |                 |                    |                              |                 |                    |
| 68F-45972-00-00                                      | Reliance®                 | 101027                 | 345932     |                  | 992003                       | 993043          | 993023             | 993203                       | 203             | 33,39              |
| 68F-45974-00-00                                      | Reliance®                 | 101028                 | 345933     |                  | 992004                       | 993044          | 993024             | 993204                       | 203             | 33,39              |
| 68F-45976-00-00                                      | Reliance®                 |                        | 345934     |                  | 992005                       | 993045          | 993025             | 993205                       | 203             | 33,39              |
| 38G-45972-00-00                                      | Reliance® (LH)            |                        | 345962     |                  | 993053                       | 993033          | 993213             | 203                          |                 | 33,39              |
| 68G-45974-00-00                                      | Reliance® (LH)            |                        | 345963     |                  | 993054                       | 993034          | 993214             | 203                          |                 | 33,39              |
| 68G-45976-00-00                                      | Reliance® (LH)            |                        | 345964     |                  | 993055                       | 993035          | 993215             | 203                          |                 | 33,39              |
| 68U-45941-00-EL                                      |                           |                        |            |                  | 992402                       |                 |                    |                              | 117             | 31                 |
| 69L-45974-20-00                                      | V MAX®                    |                        |            |                  | 992006                       | 993046          | 993026             | 993206                       | 203             | 33,39              |
| 69W-45943-00-EL                                      |                           | .032040                | 395930     |                  | 992408                       | 993408          |                    |                              | 117             | 31                 |
| 69W-45945-00-EL                                      |                           | .032042                | 395929     |                  | 992605                       | 993406          |                    |                              | 117             | 31                 |
| 69W-45947-00-EL                                      |                           | .032044                |            |                  | 992603                       |                 |                    |                              | 117             | 31                 |
| 69W-45952-00-EL                                      |                           | .032043                |            |                  | 992604                       | 993405          |                    |                              | 117             | 31                 |
| 69W-45958-00-EL                                      |                           | .032041                |            |                  | 992606                       | 993407          |                    |                              | 117             | 31                 |
| 6CB-45974-00-00                                      | V MAX® Ventless           |                        | 345935     |                  |                              |                 |                    |                              |                 | 33                 |
| 6D0-45970-00-00                                      | Saltwater Series II™      | 101028                 | 345933     |                  | 992004                       | 993044          | 993024             | 993204                       | 203             | 33,39              |
| 6D0-45972-00-00                                      | Saltwater Series II™      |                        | 345934     |                  | 992005                       | 993045          | 993025             | 993205                       | 203             | 33,39              |
| 6D0-45978-00-00                                      | Saltwater Series II™      | 101027                 | 345932     |                  | 992003                       | 993043          | 993023             | 993203                       | 203             | 33,39              |
| 6D1-45970-00-00                                      | Saltwater Series II™ (LH) |                        | 345963     |                  |                              | 993054          | 993034             | 993214                       | 203             | 33,39              |
| 6D1-45972-00-00                                      | Saltwater Series II™ (LH) |                        | 345964     |                  |                              | 993055          | 993035             | 993215                       | 203             | 33,39              |
| 6D1-45978-00-00                                      | Saltwater Series II™ (LH) |                        | 345962     |                  |                              | 993053          | 993033             | 993213                       | 203             | 33,39              |
| 6E5-45941-00-36                                      |                           | 101034                 | 335932     |                  | 992115                       | 993145          |                    |                              | See Note 1      | 32                 |
| 6E5-45941-00-EL                                      |                           | 101034                 | 335932     |                  | 992115                       | 993145          |                    |                              | See Note 1      | 32                 |
| 6E5-45943-00-36                                      |                           | 101035                 | 335933     |                  | 992116                       | 993146          |                    |                              | See Note 1      | 32                 |
| 6E5-45943-00-EL                                      |                           | 101035                 | 335933     |                  | 992116                       | 993146          |                    |                              | See Note 1      | 32                 |
| 6E5-45945-00-36                                      |                           | 101033                 | 335931     |                  | 992114                       | 993144          |                    |                              | See Note 1      | 32                 |
| 6E5-45945-00-EL                                      |                           | 101033                 | 335931     |                  | 992114                       | 993144          |                    |                              | See Note 1      | 32                 |
| 6E5-45945-01-EL                                      |                           | 101033                 | 335931     |                  | 992114                       | 993144          |                    |                              | See Note 1      | 32                 |
| 6E5-45947-00-36                                      |                           | 101032                 | 335930     |                  | 992113                       | 993143          |                    |                              | See Note 1      | 32                 |
| 6E5-45947-00-EL                                      |                           | 101032                 | 335930     |                  | 992113                       | 993143          |                    |                              | See Note 1      | 32                 |
| 6E5-45949-00-36                                      |                           | 101031                 |            |                  | 992112                       |                 |                    |                              | See Note 1      | 32                 |
| 6E5-45949-00-EL                                      |                           | 101031                 |            |                  | 992112                       |                 |                    |                              | See Note 1      | 32                 |
| 6E5-45954-00-EL                                      |                           | 101036                 |            |                  |                              |                 |                    |                              |                 | 32                 |
| 6E5-45970-10-00                                      |                           | 101028                 | 345933     |                  | 992004                       | 993044          | 993024             | 993204                       | 203             | 33,39              |
| 6E5-45970-10-98                                      |                           | 101028                 | 345933     |                  | 992004                       | 993044          | 993024             | 993204                       | 203             | 33,39              |
| 6E5-45972-10-00                                      |                           |                        | 345935     |                  | 992006                       | 993046          | 993026             | 993206                       | 203             | 33,39              |
| 6E5-45972-10-98                                      |                           |                        | 345935     |                  | 992006                       | 993046          | 993026             | 993206                       | 203             | 33,39              |
| 6E5-45976-10-00                                      |                           |                        | 345934     |                  | 992005                       | 993045          | 993025             | 993205                       | 203             | 33,39              |
| 6E5-45976-10-98                                      |                           |                        | 345934     |                  | 992005                       | 993045          | 993025             | 993205                       | 203             | 33,39              |
| 6E5-45978-10-00                                      |                           |                        | 345936     |                  |                              |                 |                    |                              |                 | 33,39              |
| 6E5-45978-10-98                                      |                           |                        | 345936     |                  |                              |                 |                    |                              |                 | 33,39              |
| 6G1-45943-00-36                                      |                           | 102002                 |            |                  |                              |                 |                    |                              |                 | 30                 |
| 6G1-45943-00-EL                                      |                           | 102002                 |            |                  |                              |                 |                    |                              |                 | 30                 |
| 6G5-45930-00-98                                      |                           |                        | 345936     |                  |                              |                 |                    |                              |                 | 33,39              |
| 6G5-45941-00-36                                      |                           |                        | 345931     |                  | 992002                       | 993042          | 993022             |                              | 203             | 33,39              |
| 6G5-45941-00-98                                      |                           |                        | 345931     |                  | 992002                       | 993042          | 993022             |                              | 203             | 33,39              |
| 6G5-45941-00-EL                                      |                           |                        | 345931     |                  | 992002                       | 993042          | 993022             |                              | 203             | 33,39              |
| 6G5-45943-00-36                                      |                           |                        | 345934     |                  | 992005                       | 993045          | 993025             | 993205                       | 203             | 33,39              |
| 6G5-45943-00-EL                                      |                           |                        | 345934     |                  | 992005                       | 993045          | 993025             | 993205                       | 203             | 33,39              |
| 6G5-45943-01-98                                      |                           |                        | 345934     |                  | 992005                       | 993045          | 993025             | 993205                       | 203             | 33,39              |
| 6G5-45945-00-36                                      |                           | 101028                 | 345933     |                  | 992004                       | 993044          | 993024             | 993204                       | 203             | 33,39              |
| 6G5-45945-00-EL                                      |                           | 101028                 | 345933     |                  | 992004                       | 993044          | 993024             | 993204                       | 203             | 33,39              |
| 6G5-45945-01-98                                      |                           | 101028                 | 345933     |                  | 992004                       | 993044          | 993024             | 993204                       | 203             | 33,39              |
| 6G5-45947-01-98                                      |                           | 101027                 | 345932     |                  | 992003                       | 993043          | 993023             | 993203                       | 203             | 33,39              |
| 6G5-45947-01-EL                                      |                           | 101027                 | 345932     |                  | 992003                       | 993043          | 993023             | 993203                       | 203             | 33,39              |
| 6G5-45949-00-36                                      |                           |                        | 345935     |                  | 992006                       | 993046          | 993026             | 993206                       | 203             | 33,39              |
| 6G5-45949-00-98                                      |                           |                        | 345935     |                  | 992006                       | 993046          | 993026             | 993206                       | 203             | 33,39              |
| 6G5-45949-00-EL                                      |                           |                        | 345935     |                  | 992006                       | 993046          | 993026             | 993206                       | 203             | 33,39              |
| 6G5-45952-00-98                                      |                           |                        | 345931     |                  | 992002                       | 993042          |                    |                              | 203             | 33,39              |
| 6G5-45952-00-EL                                      |                           |                        | 345931     |                  | 992002                       | 993042          |                    |                              | 203             | 33,39              |
| 6G5-45970-00-98                                      |                           |                        | 345931     |                  | 992002                       | 993042          |                    |                              | 203             | 33,39              |
| 6G5-45970-01-98                                      |                           |                        | 345931     |                  | 992002                       | 993042          |                    |                              | 203             | 33,39              |
| 6G5-45970-02-98                                      |                           |                        | 345931     |                  | 992002                       | 993042          |                    |                              | 203             | 33,39              |
| 6G5-45972-00-98                                      | Painted Stainless Steel   |                        | 345934     |                  | 992005                       | 993045          | 993025             | 993205                       | 203             | 33,39              |
| 6G5-45972-01-98                                      | Painted Stainless Steel   |                        | 345934     |                  | 992005                       | 993045          | 993025             | 993205                       | 203             | 33,39              |
| 6G5-45972-02-98                                      | Painted Stainless Steel   |                        | 345934     |                  | 992005                       | 993045          | 993025             | 993205                       | 203             | 33,39              |

# MICHIGAN WHEEL OEM CROSS REFERENCE

| Original Equipment Manufacturer<br>Part & Trade Mark | Standard Hub Propeller       |            |                  | XHS® / XHS II® Hub Propeller |                 |                    | XHS® / XHS II®<br>Hub Kit(s) | Catalog Page #s |                    |       |
|--|------------------------------|------------|------------------|------------------------------|-----------------|--------------------|------------------------------|-----------------|--------------------|-------|
|  | Michigan<br>Match®           | Ballistic® | Ballistic®<br>XL | Vortex®<br>XHS               | Apollo®<br>Std. | Apollo®<br>Lg. Dia |                              |                 | Apollo®<br>4-Blade |       |
| <b>YAMAHA® (Continued)</b>                           |                              |            |                  |                              |                 |                    |                              |                 |                    |       |
| 6G5-45972-03-98.....                                 | Painted Stainless Steel      |            | 345934           |                              | 992005          | 993045             | 993025                       | 993205          | 203                | 33,39 |
| 6G5-45974-00-98.....                                 | Painted Stainless Steel      | 101028     | 345933           |                              | 992004          | 993044             | 993024                       | 993204          | 203                | 33,39 |
| 6G5-45974-01-98.....                                 | Painted Stainless Steel      | 101028     | 345933           |                              | 992004          | 993044             | 993024                       | 993204          | 203                | 33,39 |
| 6G5-45974-02-98.....                                 | Painted Stainless Steel      | 101028     | 345933           |                              | 992004          | 993044             | 993024                       | 993204          | 203                | 33,39 |
| 6G5-45974-03-98.....                                 | Painted Stainless Steel      | 101028     | 345933           |                              | 992004          | 993044             | 993024                       | 993204          | 203                | 33,39 |
| 6G5-45976-00-98.....                                 | Painted Stainless Steel      |            | 345935           |                              | 992005          | 993046             | 993026                       | 993206          | 203                | 33,39 |
| 6G5-45976-01-98.....                                 | Painted Stainless Steel      |            | 345935           |                              | 992005          | 993046             | 993026                       | 993206          | 203                | 33,39 |
| 6G5-45978-00-98.....                                 | Painted Stainless Steel      | 101027     | 345932           |                              | 992003          | 993043             | 993023                       | 993203          | 203                | 33,39 |
| 6G5-45978-01-98.....                                 | Painted Stainless Steel      | 101027     | 345932           |                              | 992003          | 993043             | 993023                       | 993203          | 203                | 33,39 |
| 6G5-45978-02-98.....                                 | Painted Stainless Steel      | 101027     | 345932           |                              | 992003          | 993043             | 993023                       | 993203          | 203                | 33,39 |
| 6G5-45978-03-98.....                                 | Painted Stainless Steel      | 101027     | 345932           |                              | 992003          | 993043             | 993023                       | 993203          | 203                | 33,39 |
| 6H5-45943-00-EL.....                                 |                              | 032040     | 395930           |                              | 992408          | 993408             |                              |                 | 117                | 31    |
| 6H5-45945-00-EL.....                                 |                              | 032042     | 395929           |                              | 992605          | 993406             |                              |                 | 117                | 31    |
| 6H5-45952-00-EL.....                                 |                              | 032043     |                  |                              | 992604          | 993405             |                              |                 | 117                | 31    |
| 6H5-45958-00-EL.....                                 |                              | 032041     |                  |                              | 992606          | 993407             |                              |                 | 117                | 31    |
| 6J9-45972-B0-00.....                                 | Pro Series™                  |            | 345937           |                              |                 | 993046             | 993026                       | 993206          | 203                | 33,39 |
| 6J9-45976-10-00.....                                 | Pro Series™                  |            | 345941           |                              |                 | 993045             | 993025                       | 993205          | 203                | 33,39 |
| 6K1-45945-00-98.....                                 |                              |            | 345963           |                              |                 | 993054             | 993032                       | 993214          | 203                | 33,39 |
| 6K1-45947-00-98.....                                 |                              |            | 345962           |                              |                 | 993053             | 993033                       | 993213          | 203                | 33,39 |
| 6K1-45970-00-98.....                                 |                              |            |                  |                              |                 | 993052             | 993022                       |                 | 203                | 33,39 |
| 6K1-45970-01-98.....                                 | Painted Stainless Steel (LH) |            |                  |                              |                 | 993052             | 993022                       |                 | 203                | 33,39 |
| 6K1-45972-00-00.....                                 | Painted Stainless Steel (LH) |            | 345964           |                              |                 | 993055             | 993035                       | 993215          | 203                | 33,39 |
| 6K1-45972-00-98.....                                 | Painted Stainless Steel (LH) |            | 345964           |                              |                 | 993055             | 993035                       | 993215          | 203                | 33,39 |
| 6K1-45972-01-98.....                                 | Painted Stainless Steel (LH) |            | 345964           |                              |                 | 993055             | 993035                       | 993215          | 203                | 33,39 |
| 6K1-45974-00-00.....                                 | Painted Stainless Steel (LH) |            | 345963           |                              |                 | 993054             | 993034                       | 993214          | 203                | 33,39 |
| 6K1-45974-01-98.....                                 | Painted Stainless Steel (LH) |            | 345963           |                              |                 | 993054             | 993034                       | 993214          | 203                | 33,39 |
| 6K1-45974-02-98.....                                 | Painted Stainless Steel (LH) |            | 345963           |                              |                 | 993054             | 993034                       | 993214          | 203                | 33,39 |
| 6K1-45976-00-98.....                                 | Painted Stainless Steel (LH) |            | 345965           |                              |                 | 993056             | 993036                       | 993216          | 203                | 33,39 |
| 6K1-45978-01-98.....                                 | Painted Stainless Steel (LH) |            | 345965           |                              |                 | 993056             | 993036                       | 993216          | 203                | 33,39 |
| 6K1-45978-00-00.....                                 | Painted Stainless Steel (LH) |            | 345962           |                              |                 | 993053             | 993033                       | 993213          | 203                | 33,39 |
| 6K1-45978-00-98.....                                 | Painted Stainless Steel (LH) |            | 345962           |                              |                 | 993053             | 993033                       | 993213          | 203                | 33,39 |
| 6K1-45978-01-98.....                                 | Painted Stainless Steel (LH) |            | 345962           |                              |                 | 993053             | 993033                       | 993213          | 203                | 33,39 |
| 6K1-45978-02-98.....                                 | Painted Stainless Steel (LH) |            | 345962           |                              |                 | 993053             | 993033                       | 993213          | 203                | 33,39 |
| 6L6-45930-01-98.....                                 | Painted Stainless Steel (LH) |            |                  |                              |                 | 993154             |                              |                 | See Note 1         | 32    |
| 6L6-45970-00-98.....                                 | Painted Stainless Steel (LH) |            |                  |                              |                 | 993155             |                              |                 | See Note 1         | 32    |
| 6L6-45972-00-98.....                                 | Painted Stainless Steel (LH) |            |                  |                              |                 | 993156             |                              |                 | See Note 1         | 32    |
| 6R1-45970-AO-00.....                                 | Saltwater Series™ (LH)       |            |                  |                              |                 | 993054             | 993034                       | 993214          | 203                | 33,39 |
| 6R1-45972-AO-00.....                                 | Saltwater Series™ (LH)       |            |                  |                              |                 | 993055             | 993035                       | 993215          | 203                | 33,39 |
| 6R1-45970-AO-00.....                                 | Saltwater Series™ (LH)       |            |                  |                              |                 | 993056             | 993036                       | 993216          | 203                | 33,39 |
| 6R1-45976-AO-00.....                                 | Saltwater Series™ (LH)       |            |                  |                              |                 | 993052             |                              |                 | 203                | 33,39 |
| 6R1-45978-AO-00.....                                 | Saltwater Series™ (LH)       |            |                  |                              |                 | 993053             | 993033                       | 993213          | 203                | 33,39 |
| 6R4-45970-AO-00.....                                 | Saltwater Series™            | 101028     | 345933           |                              | 992004          | 993044             | 993024                       | 993214          | 203                | 33,39 |
| 6R4-45972-AO-00.....                                 | Saltwater Series™            |            | 345934           |                              | 992005          | 993045             | 993025                       | 993215          | 203                | 33,39 |
| 6R4-45974-AO-00.....                                 | Saltwater Series™            |            | 345935           |                              | 992006          | 993046             | 993026                       | 993206          | 203                | 33,39 |
| 6R4-45976-AO-00.....                                 | Saltwater Series™            |            | 345935           |                              | 992006          | 993046             | 993026                       | 993206          | 203                | 33,39 |
| 6R4-45978-AO-00.....                                 | Saltwater Series™            |            |                  |                              | 992003          | 993043             | 993023                       | 993203          | 203                | 33,39 |
| MAR-GYT3B-02-13.....                                 | Performance 3-Blade          |            | 305929           |                              |                 |                    |                              |                 | 117                | 31    |
| MAR-GYT3B-03-12.....                                 | Performance 3-Blade          | 032043     |                  |                              | 992604          | 993405             |                              |                 | 117                | 31    |
| MAR-GYT3B-03-13.....                                 | Performance 3-Blade          | 032042     | 395929           |                              | 992605          | 993406             |                              |                 | 117                | 31    |
| MAR-GYT3B-03-14.....                                 | Performance 3-Blade          | 032041     |                  |                              | 992606          | 993407             |                              |                 | 117                | 31    |
| MAR-GYT3B-03-15.....                                 | Performance 3-Blade          | 032040     | 395930           |                              | 992408          | 993408             |                              |                 | 117                | 31    |
| MAR-GYT3B-L4-16.....                                 | Performance 3-Blade (LH)     |            |                  |                              |                 | 993153             |                              |                 | See Note 1         | 32    |
| MAR-GYT3B-L4-18.....                                 | Performance 3-Blade (LH)     |            |                  |                              |                 | 993154             |                              |                 | See Note 1         | 32    |
| MAR-GYT3B-L4-20.....                                 | Performance 3-Blade (LH)     |            |                  |                              |                 | 993155             |                              |                 | See Note 1         | 32    |
| MAR-GYT3B-L4-22.....                                 | Performance 3-Blade (LH)     |            |                  |                              |                 | 993156             |                              |                 | See Note 1         | 32    |
| MAR-GYT3B-L6-16.....                                 | Performance 3-Blade (LH)     |            | 345962           |                              |                 | 993052             |                              |                 | 203                | 33,39 |
| MAR-GYT3B-L6-18.....                                 | Performance 3-Blade (LH)     |            | 345963           |                              |                 | 993053             | 993033                       | 993213          | 203                | 33,39 |
| MAR-GYT3B-L6-20.....                                 | Performance 3-Blade (LH)     |            | 345964           |                              |                 | 993054             | 993034                       | 993214          | 203                | 33,39 |
| MAR-GYT3B-L6-22.....                                 | Performance 3-Blade (LH)     |            | 345965           |                              |                 | 993055             | 993035                       | 993215          | 203                | 33,39 |
| MAR-GYT3B-V4-14.....                                 | Performance 3-Blade          |            | 335930           |                              |                 |                    |                              |                 |                    | 32    |
| MAR-GYT3B-V4-16.....                                 | Performance 3-Blade          | 101032     | 335931           |                              | 992113          | 993143             |                              |                 | See Note 1         | 32    |
| MAR-GYT3B-V4-18.....                                 | Performance 3-Blade          | 101033     | 335932           |                              | 992114          | 993144             |                              |                 | See Note 1         | 32    |
| MAR-GYT3B-V4-20.....                                 | Performance 3-Blade          | 101034     | 335933           |                              | 992115          | 993145             |                              |                 | See Note 1         | 32    |
| MAR-GYT3B-V4-22.....                                 | Performance 3-Blade          | 101035     |                  |                              | 992116          | 993146             |                              |                 | See Note 1         | 32    |
| MAR-GYT3B-V6-16.....                                 | Performance 3-Blade          |            | 345932           |                              | 992002          | 993042             |                              |                 | 203                | 33,39 |
| MAR-GYT3B-V6-18.....                                 | Performance 3-Blade          | 101027     | 345933           |                              | 992003          | 993043             | 993023                       | 993203          | 203                | 33,39 |



# MICHIGAN WHEEL OEM CROSS REFERENCE

| Original Equipment Manufacturer<br>Part & Trade Mark | Standard Hub Propeller |            |                  | XHS® / XHS II® Hub Propeller |                 |                    |                    | XHS® / XHS II®<br>Hub Kit(s) | Catalog Page #s |
|--|------------------------|------------|------------------|------------------------------|-----------------|--------------------|--------------------|------------------------------|-----------------|
|  | Michigan<br>Match®     | Ballistic® | Ballistic®<br>XL | Vortex®<br>XHS               | Apollo®<br>Std. | Apollo®<br>Lg. Dia | Apollo®<br>4-Blade |                              |                 |

## YAMAHA® (Continued)

|   |             |             |             |             |             |             |             |                 |       |
|---|-------------|-------------|-------------|-------------|-------------|-------------|-------------|-----------------|-------|
| MAR-GYT3B-V6-20..... Performance 3-Blade..... | 101028..... | 345934..... |             | 992004..... | 993044..... | 993024..... | 993204..... | 203.....        | 33,39 |
| MAR-GYT3B-V6-22..... Performance 3-Blade..... |             | 345935..... |             | 992005..... | 993045..... | 993025..... | 993205..... | 203.....        | 33,39 |
| MAR-GYT3B-V6-24..... Performance 3-Blade..... |             | 345936..... |             | 992006..... | 993046..... | 993026..... | 993206..... | 203.....        | 33,39 |
| MAR-GYT3B-XL-23..... Performance XL.....      |             |             | 345937..... |             |             |             |             |                 | 33,39 |
| MAR-GYT3B-XL-25..... Performance XL.....      |             |             | 345938..... |             |             |             |             |                 | 33,39 |
| MAR-GYT4B-V6-18..... Performance 4-Blade..... |             |             |             |             |             |             | 993204..... | 203.....        | 33,39 |
| MAR-GYT4B-V6-20..... Performance 4-Blade..... |             |             |             |             |             |             | 993205..... | 203.....        | 33,39 |
| MAR-GYT4B-V6-22..... Performance 4-Blade..... |             |             |             |             |             |             | 993206..... | 203.....        | 33,39 |
| MAR-GYT4B-V6-23..... Performance 4-Blade..... |             |             | 435935..... |             |             |             | 993206..... | 203.....        | 33,39 |
| MAR-GYT4B-V6-25..... Performance 4-Blade..... |             |             | 435936..... |             |             |             |             |                 | 33,39 |
| MAR-GYT4B-V6-26..... Performance 4-Blade..... |             |             | 435937..... |             |             |             |             |                 | 33    |
| MAR-VMAX3-04-18.....                          | 101034..... | 335932..... |             | 992114..... | 993144..... |             |             | See Note 1..... | 32    |
| MAR-VMAX3-04-20.....                          | 101035..... | 335933..... |             | 992115..... | 993145..... |             |             | See Note 1..... | 32    |
| MAR-VMAX3-04-22.....                          |             |             |             | 992116..... | 993146..... |             |             | See Note 1..... | 32    |
| MAR-VMAX3-06-16.....                          |             | 345932..... |             | 992002..... | 993042..... | 993022..... |             | 203.....        | 33,39 |
| MAR-VMAX3-06-18.....                          | 101027..... | 345933..... |             | 992003..... | 993043..... | 993023..... | 993203..... | 203.....        | 33,39 |
| MAR-VMAX3-06-20.....                          | 101028..... | 345934..... |             | 992004..... | 993044..... | 993024..... | 993204..... | 203.....        | 33,39 |
| MAR-VMAX3-06-22.....                          |             | 345935..... | 435935..... | 992005..... | 993045..... | 993025..... | 993205..... | 203.....        | 33,39 |
| MAR-VMAX3-06-24.....                          |             | 345936..... | 435936..... | 992006..... | 993046..... | 993026..... | 993206..... | 203.....        | 33,39 |
| MAR-VMAX3-06-26.....                          |             |             | 435937..... |             |             |             |             |                 | 33,39 |
| MAR-VMAX3-C6-18.....                          |             | 345963..... |             |             | 993053..... | 93033.....  | 993213..... | 203.....        | 33,39 |
| MAR-VMAX3-C6-20.....                          |             | 345964..... |             |             | 993054..... | 993034..... | 993214..... | 203.....        | 33,39 |
| MAR-VMAX3-C6-22.....                          |             | 345965..... |             |             | 993056..... | 993036..... | 993216..... | 203.....        | 33,39 |

| YAMAHA® |  |     |
|---------|--|-----|
| Note 1  | T50, 1996-Present; 15 Tooth Spline                     | 208 |
|         | 60-100 HP (Including 4-Stroke), 1984-Present; 15 Tooth | 208 |
|         | 80-140 HP, 1978-1983; 15 Tooth Spline                  | 202 |
|         | 115-130 HP, 1984-Present; 15 Tooth Spline              | 203 |

| MERCURY®/MARINER® |  |     |
|-------------------|--|-----|
| Note 3            | 40, 50 & 60 HP Bigfoot; 15 Tooth Spline                  | 202 |
|                   | 70-140 HP (Except 135 HP), 1961-Present; 15 Tooth Spline | 202 |
|                   | XR-4/XR-6; 15 Tooth Spline                               | 202 |
| HONDA® OUTBOARDS  |  |     |
| Note 3            | 75-90 HP, Thru 1988; 15 Tooth Spline                     | 202 |
|                   | 75-90 HP, 1999-Present; 15 Tooth Spline                  | 207 |
|                   | 115-130 HP, 1998-Present; 15 Tooth Spline                | 207 |
| FORCE®            |  |     |
| Note 3            | 75-150 HP, 1995-Present; 15 Tooth Spline                 | 202 |
|                   | YAMAHA®  |     |
| Note 3            | 80-140 HP, 1978-1983; 15 Tooth Spline                    | 202 |

| EVINRUDE®/JOHNSON® OUTBOARDS |   |     |
|------------------------------|---|-----|
| Note 5                       | 60 HP & 70 HP 4-Stroke, 1998-Present; 13 Tooth Spline | 210 |
|                              | All Other V4 Engine Applications; 13 Tooth Spline     | 206 |
|                              | OMC®/COBRA® STERNDRIVES                               |     |
| Note 5                       | Model 400/Cobra Sterndrives; 13 Tooth Spline          | 206 |

| EVINRUDE®/JOHNSON® OUTBOARDS |   |     |
|------------------------------|---|-----|
| Note 2                       | 90-140 HP Large Gearcase, 1976-1990; 15 Tooth Spline    | 201 |
|                              | 90-140 HP Large Gearcase, 1991-Present; 15 Tooth Spline | 200 |
|                              | 150-300 HP, 1976-1990; 15 Tooth Spline                  | 201 |
|                              | 150-300 HP, 1991-Present; 15 Tooth Spline               | 200 |
|                              | OMC®/COBRA® STERNDRIVES                                 |     |
| Note 2                       | Model 800/Cobra/King Cobra, 1978-1990; 15 Tooth Spline  | 201 |
|                              | Model 800/Cobra/King Cobra, 1991-1994; 15 Tooth Spline  | 200 |

| NISSAN®/TOHATSU® |  |     |
|------------------|--|-----|
| Note 4           | 90 HP, 1987-Present; 15 Tooth Spline                   | 209 |
|                  | 115 HP, 1992-Present; 15 Tooth Spline                  | 209 |
|                  | 120 HP/140 HP, 1988-Present; 15 Tooth Spline           | 209 |
| SUZUKI®          |  |     |
| Note 4           | DF90/DF115, 2001-Present; 15 Tooth Spline              | 225 |
|                  | DF140, 2001-Present; 15 Tooth Spline                   | 226 |
|                  | DF70A/DF80A/DF90A, 2009-Present; 15 Tooth Spline       | 227 |
| JOHNSON®         |  |     |
| Note 4           | 90/115 HP (4-Stroke), 2003-Present; 15 Tooth Spline    | 225 |
|                  | 140 HP (4-Stroke), 2003-Present; 15 Tooth Spline       | 226 |
| YAMAHA®          |  |     |
| Note 4           | 50-100 HP (Including 4-Stroke), 1984-Present; 15 Tooth | 208 |
|                  | 115-130 HP, 1984-Present; 15 Tooth Spline              | 203 |

Evinrude®, Johnson® and Cobra® are registered trademarks of BRP US, Inc. Honda® is a registered trademark of American Honda Motor Co., Inc. Mercury®, Mariner®, Force®, MerCruiser®, and Alpha One™ are registered trademarks of Brunswick Corporation. Nissan® is a registered trademark of Nissan Marine. Suzuki® is a registered trademark of American Suzuki Motor Corporation. Tohatsu® is a registered trademark of Tohatsu Corp. Volvo® is a registered trademark of AB Volvo Penta. Yamaha® is a registered trademark of Yamaha Motor Corporation, U.S.A. Solas® is a registered trademark of Solas Science & Engineering Co., Ltd. Turning Point® is a registered trademark of Turning Point Propellers, Inc.

Additional product names may belong to Original Equipment Manufacturers (OEM). All references to OEM, after-market, their trade names or their part numbers are for replacement identification purposes only.



## LIMITED WARRANTY

Michigan Wheel Marine warrants to the original consumer purchaser and original motor fitted, that for a period of one year from the date of purchase, the body of the Michigan Match<sup>®</sup>, Vortex<sup>®</sup>, Apollo<sup>®</sup> or Ballistic<sup>®</sup> propeller will be free of any defect in material or workmanship that results in blade or hub fracture or failure under normal pleasure boat usage. Michigan Wheel Marine also warrants to the original consumer purchaser, under the same parameters of use described above, that the propeller bushing, including XHS<sup>®</sup>/XHS II<sup>®</sup> hub kit components, will be free from any defect in material or workmanship for a period of one year from the date of purchase. Proof of purchase required for all warranty claims.

Some surface discoloration of propellers and hardware is unavoidable, and will not be covered by this warranty. This warranty also does not cover normal wear, accidental damage, modification, improper installation, improper maintenance, or other circumstances that are not the direct result of a defect in the material or workmanship of the propeller.

The sole obligation of Michigan Wheel Marine under this warranty is to repair or replace the propeller, in the sole discretion of Michigan Wheel Marine, and at its expense. In order to make a replacement claim, please contact the Michigan Wheel Marine Customer Service Department, at (616) 452-6941, for a "Return Materials Authorization" number (RMA#), and shipping instructions. The RMA# is to be indicated along with our given address on the label, and the shipping carton should include your return shipping address, your phone number, and a copy of your original purchase receipt. The warranty will not cover any expense of propeller removal, shipping, or reinstallation of the propeller.

The above warranty is Michigan Wheel Marine's sole warranty for the Michigan Match<sup>®</sup>, Vortex<sup>®</sup>, Apollo<sup>®</sup> or Ballistic<sup>®</sup> propellers as well as XHS<sup>®</sup>/XHS II<sup>®</sup> hub kits. Michigan Wheel Marine expressly disclaims all other warranties, expressed or implied, including, without limitation, the warranties of merchantability and fitness for a particular purpose and excludes all liability for incidental or consequential damages, loss of use of the propeller, costs, and expenses.

Any actions arising out of this warranty and the sale of this product shall be governed by Michigan law and may only be brought, heard and decided in Kent County Circuit Court, in the State of Michigan, U.S.A., or in the United States District Court for the Western District of Michigan.

Michigan Wheel Marine  
1501 Buchanan Avenue S.W.  
Grand Rapids, MI 49507  
Phone: (616) 452-6941

### Need Your Propeller Repaired?

Congratulations, you have chosen a top quality propeller. Should it become damaged during use, you want a qualified trained technician to repair it. Contact the **National Marine Propeller Association (NMPA)** at phone: 616.235.6672, fax: 616.235.0144, or visit them on the web: [www.nmpa.net](http://www.nmpa.net) for a certified propeller repair shop near you.

Warranty claims are to be addressed directly to **Michigan Wheel Marine** per instructions on this warranty statement and not to the **NMPA**.

# Michigan Wheel Marine

## UNDENIABLE HISTORY...

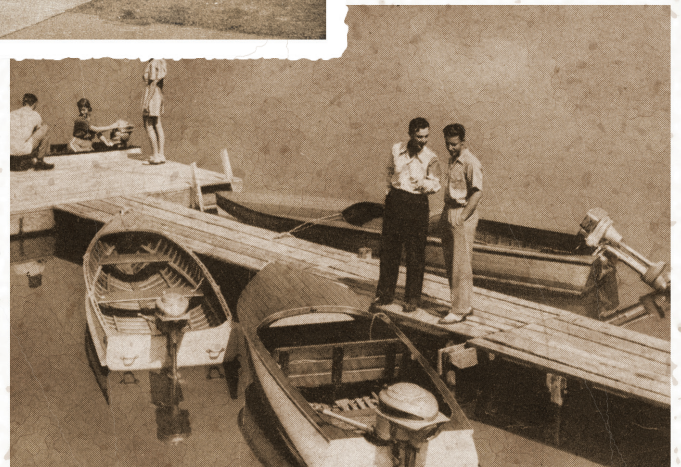

## ...UNMISTAKABLE PERFORMANCE.

# Michigan Wheel Marine

World Headquarters  
1501 Buchanan Avenue S.W.  
Grand Rapids, MI 49507

Phone: 1-616-452-6941

Fax: 1-616-247-0227

[info@miwheel.com](mailto:info@miwheel.com)

[www.miwheel.com](http://www.miwheel.com)

Michigan Wheel  
MARINE 

Europe Headquarters  
Unit C1 B, Pottery Road  
Newton Abbot, Devon TQ12 3BN  
United Kingdom

Phone: +44 1626 351723

Fax: +44 1626 351724

[sales@miwheel-europe.com](mailto:sales@miwheel-europe.com)

[www.miwheel-europe.com](http://www.miwheel-europe.com)

Michigan Wheel Marine   
Middle East ✿ Africa ✿ Asia

Middle East • Africa • Asia Headquarters  
P.O. Box 54805, DY-1, Show Room No. 7  
Al Jadaf Ship Docking Yard, Dubai,  
United Arab Emirates

Phone: +971 4 3243867

Fax: +971 4 3243868

[sales@miwheel-meaa.com](mailto:sales@miwheel-meaa.com)

[www.miwheel-meaa.com](http://www.miwheel-meaa.com)



**BALLISTIC**  
STAINLESS STEEL PROPS



**Ambush4**



Proud Members: NMDA, NMMA, NAMPS, NMPA, UMMA

© 2011 Michigan Wheel Marine  
Printed in the USA. June 2011  
All Rights Reserved.

Part Number 99021212